

TEC-5521C  
TEC-5531C  
TEC-5521E  
TEC-5531E  
TEC-5521K  
TEC-5531K

# SERVICE MANUAL

## DEFIBRILLATOR

**TEC-5500**

**Trademark**



The mark printed on the holter card and SD card adapter that are used in this instrument is a trademark. The company name and model name are trademarks and registered trademarks of each company.

# Contents

GENERAL HANDLING PRECAUTIONS .....	i
WARRANTY POLICY .....	ii
EMC RELATED CAUTION .....	iii
Conventions Used in this Manual and Instrument .....	v
Dangers, Warnings, Cautions and Notes .....	v
Explanations of the Symbols in this Manual and Instrument .....	vi
<b>Section 1   General .....</b>	<b>1C.1</b>
Introduction .....	1.1
Models and Functions .....	1.1
General Information on Servicing .....	1.2
Service Policy, Service Parts and Patient Safety Checks .....	1.4
Service Policy .....	1.4
Service Parts .....	1.4
Patient Safety Checks .....	1.5
Maintenance Equipments and Tools .....	1.5
Important Safety Information .....	1.6
Specifications .....	1.21
Panel Description .....	1.26
Front Panel .....	1.26
Top Panel (TEC-5531 Series Only) .....	1.27
External Paddles .....	1.28
Left Side Panel .....	1.28
Rear Panel .....	1.29
Composition .....	1.30
Standard Components .....	1.30
Options .....	1.32
Board/Unit Location .....	1.34
Block Diagram .....	1.35
<b>Section 2   Troubleshooting .....</b>	<b>2C.1</b>
How to Troubleshoot .....	2.1
Error Code .....	2.2
Defibrillation .....	2.3
Operation Panel .....	2.4
Communication .....	2.5
Data Error .....	2.6
Pacing (TEC-5531 Series Only) .....	2.6
Message .....	2.7
Troubleshooting .....	2.9
General .....	2.9
Defibrillation .....	2.10

Monitoring .....	2.11
Recording .....	2.13
Battery .....	2.13
Pacing (TEC-5531 Series Only) .....	2.14

**Section 3    *Disassembly* ..... 3C.1**

Before You Begin .....	3.1
Warnings, Cautions and Notes .....	3.1
Required Tools .....	3.2
Connection Diagram .....	3.3
Removing the Lower Casing .....	3.5
Removing the Paddles .....	3.5
Removing the Battery Pack .....	3.5
Removing the Lower Casing .....	3.6
Removing the CPU Board and Mother board .....	3.7
Removing the CPU Board .....	3.7
Removing the Mother Board .....	3.8
Removing the Front Chassis .....	3.9
Removing the Side Casing .....	3.10
Removing the Recorder Unit .....	3.11
Removing the Biphasic HV Unit .....	3.12
Removing the HV Capacitor .....	3.14
Attaching the HV Capacitor .....	3.15
Removing the AC/DC Unit .....	3.16
Removing the Test Load Board .....	3.17
Removing the Pacer Board (TEC-5531 Series Only) .....	3.18
Removing the LCD Unit .....	3.19
Removing the Key Board .....	3.20
Removing the Energy/Mode Select Control Knob .....	3.20
Removing the Speaker .....	3.21
Removing the Paddle Lock Springs .....	3.22
Removing the AC SOURCE Socket .....	3.23

**Section 4    *Maintenance* ..... 4C.1**

General .....	4.1
Daily Checks .....	4.1
Monthly Checks .....	4.1
System Maintenance Screen .....	4.3
Calling Up the System Maintenance Screen .....	4.3
About the Menu Items .....	4.4
System Maintenance Screen Flowchart .....	4.5
Default Settings .....	4.6
Flash Save Procedure .....	4.7
Configuration Screen .....	4.8
Adjust AD Screen .....	4.9
Adjust ECG A/D Screen .....	4.10
Adjust HV AD Screen .....	4.12

Adjust Battery AD Screen .....	4.15
Paddle Contact A/D Screen .....	4.16
Check Hardware Screen .....	4.17
Check Key Screen .....	4.17
Check LED Screen .....	4.19
Check LCD Screen .....	4.19
Check Recorder Screen .....	4.19
Check Time Constant Screen .....	4.20
Check Buzzer Screen .....	4.21
Check Memory Screen .....	4.21
Check Voice Screen .....	4.22
Check ECG Frequency Screen .....	4.23
A/D View Screen .....	4.24
Operation Time Screen .....	4.24
Version Up Screen .....	4.25
Debug Mode Screen .....	4.25
Check String Screen .....	4.26
Memory Dump Screen .....	4.26
Periodic Replacement Schedule .....	4.27
Maintenance Check Sheet .....	4.28
<b>Section 5 Replaceable Parts List.....</b>	<b>5C.1</b>
Replaceable Parts List .....	5.2

**This page is intentionally left blank.**

## GENERAL HANDLING PRECAUTIONS

This device is intended for use only by qualified medical personnel. Use only Nihon Kohden approved products with this device. Use of non-approved products or in a non-approved manner may affect the performance specifications of the device. This includes, but is not limited to, batteries, recording paper, pens, extension cables, electrode leads, input boxes and AC power.

**Please read these precautions thoroughly before attempting to operate the instrument.**

- 1. To safely and effectively use the instrument, its operation must be fully understood.**
- 2. When installing or storing the instrument, take the following precautions:**
  - (1) Avoid moisture or contact with water, extreme atmospheric pressure, excessive humidity and temperatures, poorly ventilated areas, and dust, saline or sulphuric air.
  - (2) Place the instrument on an even, level floor. Avoid vibration and mechanical shock, even during transport.
  - (3) Avoid placing in an area where chemicals are stored or where there is danger of gas leakage.
  - (4) The power line source to be applied to the instrument must correspond in frequency and voltage to product specifications, and have sufficient current capacity.
  - (5) Choose a room where a proper grounding facility is available.
- 3. Before Operation**
  - (1) Check that the instrument is in perfect operating order.
  - (2) Check that the instrument is grounded properly.
  - (3) Check that all cords are connected properly.
  - (4) Pay extra attention when the instrument is in combination with other instruments to avoid misdiagnosis or other problems.
  - (5) All circuitry used for direct patient connection must be doubly checked.
  - (6) Check that battery level is acceptable and battery condition is good when using battery-operated models.
- 4. During Operation**
  - (1) Both the instrument and the patient must receive continual, careful attention.
  - (2) Turn power off or remove electrodes and/or transducers when necessary to assure the patient's safety.
  - (3) Avoid direct contact between the instrument housing and the patient.
- 5. To Shutdown After Use**
  - (1) Turn power off with all controls returned to their original positions.
  - (2) Remove the cords gently; do not use force to remove them.
  - (3) Clean the instrument together with all accessories for their next use.
- 6. The instrument must receive expert, professional attention for maintenance and repairs. When the instrument is not functioning properly, it should be clearly marked to avoid operation while it is out of order.**
- 7. The instrument must not be altered or modified in any way.**
- 8. Maintenance and Inspection:**
  - (1) The instrument and parts must undergo regular maintenance inspection at least every 6 months.
  - (2) If stored for extended periods without being used, make sure prior to operation that the instrument is in perfect operating condition.

(3) Technical information such as parts list, descriptions, calibration instructions or other information is available for qualified user technical personnel upon request from your Nihon Kohden distributor.

9. **When the instrument is used with an electrosurgical instrument, pay careful attention to the application and/or location of electrodes and/or transducers to avoid possible burn to the patient.**

## **WARRANTY POLICY**

Nihon Kohden Corporation (NKC) shall warrant its products against all defects in materials and workmanship for one year from the date of delivery. However, consumable materials such as recording paper, ink, stylus and battery are excluded from the warranty.

NKC or its authorized agents will repair or replace any products which prove to be defective during the warranty period, provided these products are used as prescribed by the operating instructions given in the operator's and service manuals.

No other party is authorized to make any warranty or assume liability for NKC's products. NKC will not recognize any other warranty, either implied or in writing. In addition, service, technical modification or any other product change performed by someone other than NKC or its authorized agents without prior consent of NKC may be cause for voiding this warranty.

Defective products or parts must be returned to NKC or its authorized agents, along with an explanation of the failure. Shipping costs must be pre-paid.

This warranty does not apply to products that have been modified, disassembled, reinstalled or repaired without Nihon Kohden approval or which have been subjected to neglect or accident, damage due to accident, fire, lightning, vandalism, water or other casualty, improper installation or application, or on which the original identification marks have been removed.

In the USA and Canada other warranty policies may apply.

---

---

### **CAUTION**

**United States law restricts this device to sale by or on the order of a physician.**

---

---



---

## EMC RELATED CAUTION

This equipment and/or system complies with IEC 60601-2 International Standard for electromagnetic compatibility for medical electrical equipment and/or system. However, an electromagnetic environment that exceeds the limits or levels stipulated in IEC 60601-1-2, can cause harmful interference to the equipment and/or system or cause the equipment and/or system to fail to perform its intended function or degrade its intended performance. Therefore, during the operation of the equipment and/or system, if there is any undesired deviation from its intended operational performance, you must avoid, identify and resolve the adverse electromagnetic effect before continuing to use the equipment and/or system.

The following describes some common interference sources and remedial actions:

- 1. Strong electromagnetic interference from a nearby emitter source such as an authorized radio station or cellular phone:**  
Install the equipment and/or system at another location. Keep the emitter source such as cellular phone away from the equipment and/or system, or turn off the cellular phone.
- 2. Radio-frequency interference from other equipment through the AC power supply of the equipment and/or system:**  
Identify the cause of this interference and if possible remove this interference source. If this is not possible, use a different power supply.
- 3. Effect of direct or indirect electrostatic discharge:**  
Make sure all users and patients in contact with the equipment and/or system are free from direct or indirect electrostatic energy before using it. A humid room can help lessen this problem.
- 4. Electromagnetic interference with any radio wave receiver such as radio or television:**  
If the equipment and/or system interferes with any radio wave receiver, locate the equipment and/or system as far as possible from the radio wave receiver.
- 5. Interference of lightning**  
When lightning occurs near the location where the equipment and/or system is installed, excessive voltage may be generated in the equipment and/or system. In such a case, disconnect the AC power cord from the equipment and/or system and operate the equipment and/or system by battery power, or use an uninterruptible power supply.
- 6. Use with other equipment**  
When the equipment and/or system is adjacent to or stacked with other equipment, the equipment and/or system may affect the other equipment. Before use, check that the equipment and/or system operates normally with the other equipment.
- 7. Use of unspecified accessory, transducer and/or cable**  
When an unspecified accessory, transducer and/or cable is connected to this equipment and/or system, it may cause increased electromagnetic emission or decreased electromagnetic immunity. The specified configuration of this equipment and/or system complies with the electromagnetic requirements with the specified configuration. Only use this equipment and/or system with the specified configuration.

**Caution - continued**

**8. Use of unspecified configuration**

When the equipment and/or system is used with the unspecified system configuration different than the configuration of EMC testing, it may cause increased electromagnetic emission or decreased electromagnetic immunity. Only use this equipment and/or system with the specified configuration.

**9. Measurement with excessive sensitivity**

The equipment and/or system is designed to measure bioelectrical signals with a specified sensitivity. If the equipment and/or system is used with excessive sensitivity, artifact may appear by electromagnetic interference and this may cause mis-diagnosis. When unexpected artifact appears, inspect the surrounding electromagnetic conditions and remove this artifact source.

**If the above suggested remedial actions do not solve the problem, consult your Nihon Kohden distributor or representative for additional suggestions.**

---

For EMC compliance, refer to “Specification - Electromagnetic Compatibility” in the Reference section

**The CE mark is a protected conformity mark of the European Community. The products herewith comply with the requirements of the Medical Device Directive 93/42/EEC.**

## Conventions Used in this Manual and Instrument

### Dangers, Warnings, Cautions and Notes

Dangers, Warnings, cautions and notes are used in this manual to alert or signal the reader to specific information.

---

---

#### DANGER

A danger is used to alert the user to a hazardous situation which will cause death or serious injury.

---

---

---

---

#### WARNING

A warning alerts the user to the possible injury or death associated with the use or misuse of the instrument.

---

---

---

---

#### CAUTION

A caution alerts the user to possible injury or problems with the instrument associated with its use or misuse such as instrument malfunction, instrument failure, damage to the instrument, or damage to other property.

---

---

---

---



















#### NOTE

A note provides specific information, in the form of recommendations, prerequisites, alternative methods or supplemental information.























## Explanations of the Symbols in this Manual and Instrument

The following symbols found in this manual/instrument bear the respective descriptions as given.

### On main unit

Symbol	Description	Symbol	Description
	AC power operation		Input
	Charging		Dangerous voltage
	Charged (Battery charging is finished)		ECG
	ECG lead		Pacing start
	ECG sensitivity		Pacing stop
	Alarm off		Attention, consult operator's manual
	Real time/delayed recording	<i>ActiBiphasic</i>	Provides ActiBiphasic waveform defibrillation function
	Event recording	<b>IPX1</b>	Complying with IEC 60529 IPX1
	Inserting or removing the memory card	<b>IPX4</b>	Complying with IEC 60529 IPX4
	Defibrillation-proof type BF applied part	<b>IPX7</b>	Complying with IEC 60529 IPX7
	Defibrillation-proof type CF applied part	<b>CE</b> 0086	The CE mark is a protected conformity mark of European Community. The products herewith comply with the requirements of the Medical Device Directive 93/42/EEC.
	Output		

## On LCD

Symbol	Description	Symbol	Description
	Battery fully charged		Add Z-fold recording paper
	More than 2/3 battery charge remains		QRS sync mark
	More than 1/3 battery charge remains		The point of implanted pacemaker pulse output
	Battery power for one 270 J charging remains		AC power operation
	Battery operation not available		Alarm off
	Real time/delayed recording		Event recording
	SD card inserted		Cannot write to the SD card
	Writing to the SD card		Can eject SD card
	ECG cascaded display		Report recording
	AED analysis paused		SpO2 pulse wave unstable
	CPR start		VF/VT alarm off

**This page is intentionally left blank.**

# *Section 1    General*

Introduction .....	1.1
Models and Functions .....	1.1
General Information on Servicing .....	1.2
Service Policy, Service Parts and Patient Safety Checks .....	1.4
Service Policy .....	1.4
Service Parts .....	1.4
Patient Safety Checks .....	1.5
Maintenance Equipments and Tools .....	1.5
Important Safety Information .....	1.6
Specifications .....	1.21
Panel Description .....	1.26
Front Panel .....	1.26
Top Panel (TEC-5531 Series Only) .....	1.27
External Paddles .....	1.28
Left Side Panel .....	1.28
Rear Panel .....	1.29
Composition .....	1.30
Standard Components .....	1.30
Options .....	1.32
Board/Unit Location .....	1.34
Block Diagram .....	1.35

**This page is intentionally left blank.**



## Introduction

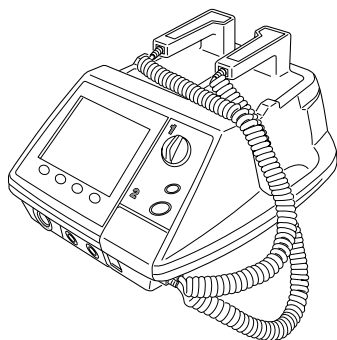

This service manual provides useful information to qualified service personnel to understand, troubleshoot, service, maintain and repair this TEC-5500 series defibrillator

The information in the operator's manual is primarily for the user. However, it is important for service personnel to thoroughly read the operator's manual and service manual before starting to troubleshoot, service, maintain or repair this defibrillator. This is because service personnel needs to understand the operation of the defibrillator in order to effectively use the information in the service manual.

## Models and Functions

Functions		TEC-5521	TEC-5531
Defibrillation and synchronized cardioversion	External paddles	Standard	Standard
	Internal paddles	Option	Option
	Disposable pads	Option	Option
	Pediatric electrode assy 44 mm $\phi$	Option	Option
3 lead ECG		Standard	Standard
AED function		Standard	Standard
Noninvasive pacing		Not available	Standard
SpO <sub>2</sub> measurement		Option	Option
CO <sub>2</sub> measurement		Option	Option
Voice prompt		Standard	Standard
5 lead ECG		Option	Option
External ECG input		Option	Option
External ECG output		Option	Option
SD card slot		Standard	Standard
Sound recording		Standard	Standard

## General Information on Servicing

Note the following information when servicing the defibrillator.

---

---

### CAUTIONS

#### Safety

- There is the possibility that the outside surface of the defibrillator, such as the operation keys, could be contaminated by contagious germs, so disinfect and clean the defibrillator before servicing it. When servicing the defibrillator, wear rubber gloves to protect yourself from infection.
- There is the possibility that when the lithium battery is broken, a solvent inside the lithium battery could flow out or a toxic substance inside it could come out. If the solvent or toxic substance touches your skin or gets into your eye or mouth, immediately wash it with a lot of water and see a physician.

#### Liquid ingress

The defibrillator is not waterproof, so do not install the defibrillator where water or liquid can get into or fall on the defibrillator. If liquid accidentally gets into the defibrillator or the defibrillator accidentally drops into liquid, disassemble the instrument, clean it with clean water and dry it completely. After reassembling, verify that there is nothing wrong with the patient safety checks and function/performance checks. If there is something wrong with the defibrillator, contact your Nihon Kohden representative for repair.

#### Environmental Safeguards

Depending on the local laws in your community, it may be illegal to dispose of the lithium battery in the regular waste collection. Check with your local officials for proper disposal procedures.

#### Disinfection and cleaning

To disinfect the outside surface of the defibrillator, wipe it with a non-abrasive cloth moistened with any of the disinfectants listed below. Do not use any other disinfectants or ultraviolet rays to disinfect the defibrillator.

- |                                           |      |
|-------------------------------------------|------|
| - Chlorohexidine gluconate solution:      | 0.5% |
| - Benzethonium chloride solution:         | 0.2% |
| - Glutaraldehyde solution:                | 2.0% |
| - Benzalkonium chloride:                  | 0.2% |
| - Hydrochloric alkyl diaminoethylglycine: | 0.5% |

**Caution - continued****Transport**

- Use the specified shipment container and packing material to transport the defibrillator. If necessary, double pack the defibrillator. Also, put the defibrillator into the shipment container after packing so that the buffer material does not get into the inside of the defibrillator.
- When transporting a board or unit of the defibrillator, be sure to use a conductive bag on. Never use an aluminum bag when transporting a board or unit on which a lithium battery is mounted. Also, never use a styrene foam or plastic bag which generates static electricity to wrap the board or unit of the defibrillator.

**Handling the defibrillator**

- Because the outside surface of the defibrillator is made of resin, the outside surface of the defibrillator is easily damaged. So when handling the defibrillator, remove clutter from around the defibrillator and be careful to not damage the defibrillator or get it dirty.
- Because most of the boards in the defibrillator are multilayer boards with surface mounted electrical devices (SMD), when removing and soldering the electrical devices, a special tool is required. To avoid damaging other electrical components, do not remove and solder SMD components yourself.

**Measuring and Test Equipment**

Maintain the accuracy of the measuring and test equipment by checking and calibrating it according to the check and calibration procedures.

---

## Service Policy, Service Parts and Patient Safety Checks

### Service Policy

Our technical service policy for this defibrillator is to replace the faulty unit, board or part or damaged mechanical part with a new one. Do not perform electrical device or component level repair of the multilayer board or unit. We do not support component level repair outside the factory for the following reasons:

- Most of the boards are multilayer boards with surface mounted electrical devices, so the mounting density of the board is too high.
- A special tool or high degree of repair skill is required to repair the multilayer boards with surface mounted electrical devices.

Only disassemble the defibrillator or replace a board or unit in an environment where the defibrillator is protected against static electricity.

As background knowledge for repair, pay special attention to the following:

- You can reduce the repair time by considering the problem before starting repair.
- You can clarify the source of most of the troubles using the information from the troubleshooting tables. Refer to “Troubleshooting“ of this manual.

### Service Parts

Refer to “Replaceable Parts List” of this manual for the service parts for technical service that we provide.

#### NOTE

**When ordering parts or accessories from your Nihon Kohden representative, please quote the NK code number and part name which is listed in this service manual, and the name or model of the unit in which the required part is located. This will help us to promptly attend to your needs. Always use parts and accessories recommended or supplied by Nihon Kohden Corporation to assure maximum performance from your defibrillator.**

## Patient Safety Checks

Periodic maintenance procedures and diagnostic check procedures are provided in this manual to ensure that the defibrillator is operating in accordance with its design and production specifications. To verify that the defibrillator is working in a safe manner with regard to patient safety, patient safety checks should be performed on the defibrillator before it is first installed, periodically after installation, and after any repair is made on the defibrillator.

For patient safety checks, perform the following checks as described in the IEC60601-1 “Medical electrical equipment - Part 1: General requirements for safety”:

- Protective earth resistance check
- Earth leakage current check
- Enclosure leakage current check
- Patient leakage current check
- Withstanding voltage check

## Maintenance Equipments and Tools

### Test equipment

When repairing or calibrating the defibrillator, the following test equipment is required.

- Oscilloscope: 2 channels or more for input signal, 50 mV to 5 V input range, 1/10 attenuating probe and 100 MHz or more frequency response characteristic must be provided.
- Power supply
- Oscillator: standard type
- Digital voltmeter: standard type (An oscilloscope can be used instead of the digital voltmeter.)

## Important Safety Information

### General

---

---

#### DANGER

- Never use the defibrillator in a flammable atmosphere (i.e. areas with flammable anesthetics, concentrated oxygen, hyperbaric oxygen) or in an environment in which an electrical arc could ignite an explosion. Otherwise, the defibrillator will explode or fire.
  - Never use the defibrillator in a high-pressure oxygen medical care tank. Otherwise, the defibrillator will explode or fire.
- 
- 

#### WARNING

- The defibrillator generates high voltage. The defibrillator must only be operated by trained and qualified medical personnel.
  - Radiofrequency or Electromagnetic Field  
Do not use any kind of non-essential non-patient care device within a radius of 1 meter around the defibrillator. The use of non-essential non-patient care devices that emit radiofrequency or electromagnetic fields may interfere with the operation of the defibrillator by causing noise on the ECG waveform or error messages. If a non-essential non-patient care device is accidentally placed near the defibrillator, quickly remove it.
  - MRI examination
    - Do not install this defibrillator in an MRI examination room. The defibrillator may not operate properly due to high-frequency magnetic noise from the MRI.
    - When performing MRI tests, remove all electrodes and transducers from the patient which are connected to this defibrillator. Failure to follow this warning may cause serious electrical burn on the patient due to local heating caused by dielectric electromotive force. For details, refer to the instruction manual for the MRI.
  - Using with ESU
    - When using this defibrillator with an ESU, the ESU return plate and the electrodes for monitoring must be firmly attached to the patient. If the return plate is not attached correctly, it may burn the patient's skin where the electrodes are attached. Refer to the instruction manual for the ESU.
    - When using an ESU, use this defibrillator only in the MONITOR mode and use the ECG electrodes for monitoring. Do not monitor ECG with disposable pads, external paddles or internal paddles. Otherwise, high frequency energy from the ESU causes abnormal current to flow in the patient and unexpected discharge. This causes serious electrical burn, shock, or other injury and damages the defibrillator.
- 
-

---

---

### WARNING continued

- **Surrounding Conditions**  
Fluids such as Ringer's saline solution and blood are excellent electrical conductors; to avoid creating potentially dangerous electrical paths, keep the defibrillator and the immediate area clean and dry at all times.
- 
- 

---

---

### CAUTION

- Install the defibrillator and ESU appropriately and perform equipotential grounding. Otherwise, noise from the ESU may be falsely recognized as QRS and ECG monitoring may not be performed properly.
  - Use only Nihon Kohden products and specified parts and accessories. When other products, parts or accessories are used, the defibrillator heats up and breaks down, and monitoring stops.
  - Do not reuse disposable products.
- 
- 

## Installation

---

---

### WARNING

- Connect only the specified instrument to the defibrillator by following the specified procedure. Otherwise, electrical leakage current may harm the patient and operator.
  - Connect only the specified instruments to the connector or sockets marked with  by following the specified procedure. Otherwise, electrical leakage current may harm the patient and operator.
  - Only use the provided power cord. Failure to follow this warning may cause electrical shock to the patient and operator, and may damage the defibrillator. When the provided power cord cannot be used, operate the defibrillator on battery power.
  - For patient safety, equipotential grounding of all instruments must be performed. Consult with a qualified biomedical engineer.
  - Do not connect several grounding leads directly to the equipotential terminal because the grounding lead may be disconnected from the terminal.
- 
- 

---

---

### CAUTION

- The defibrillator should only be connected to external equipment which complies with the CISPR 11 Second Edition 1990-09, Group 1 and Class B standard.
  - Use only the KD-028A Cart for this defibrillator. If another cart is used, the cart may tip over or the defibrillator may fall off.
- 
-

## Battery

---

---

### DANGER

- Keep the battery pack away from fire. Do not heat the battery pack. Otherwise, the electrolyte comes out and the battery pack explodes.
- Never short-circuit the + and – terminals on the battery pack with a wire. Never store or carry the battery pack with metal such as necklace or hair pins. The battery pack short-circuits and a large current flows, causing leakage of the substance inside the battery and battery explosion.
- Never disassemble or modify the battery pack. Never damage or directly solder the sheath tube. The battery pack short-circuits, the electrolyte comes out and the battery pack explodes.
- Do not subject the battery pack to a strong mechanical shock. The battery leaks and explodes.
- Do not use a battery which is damaged, such as from falling. There is a gas discharge valve inside the battery and if this valve is damaged, the gas cannot be discharged, causing the battery to explode.
- If the battery pack is damaged and the substance inside the battery (alkaline liquid) contacts the eyes or skin, wash immediately and thoroughly with water and see your physician. Never rub your eyes, otherwise you may lose your eyesight.
- The battery pack has + and – polarity. Make sure that the battery is installed with the correct polarity direction. Otherwise, the substance inside the battery leaks and the battery pack explodes.
- Do not charge the battery pack with an instrument other than this defibrillator. With another instrument, abnormal current flows and the substance inside the battery leaks and the battery explodes.
- Do not connect the battery pack to an AC outlet or lighter socket in a car. The substance inside the battery leaks and the battery pack explodes.

---

---

### WARNING

- Check the battery performance once a month.
- After battery check, immediately charge the battery.
- When you start using a new battery pack, write down the date of battery first use on the label on the battery pack.
- Replace the battery pack every one year.
- During the battery test, the defibrillator cannot perform defibrillation or cardioversion with battery power. Use the defibrillator on AC operation or use another defibrillator. If the battery is deteriorated or is not charged enough, defibrillation or cardioversion cannot be performed.
- Do not immerse the battery pack in water or seawater. The battery heats up and rusts and the substance inside the battery leaks.
- Never use a battery pack which is damaged, discolored or has leakage. A damaged battery explodes if used.
- Do not leave the battery unused for more than one year. The battery may leak.



**CAUTION**

- **When inserting or removing the battery, disconnect the power cord from the defibrillator. Otherwise, the operator may get electrical shock.**
  - **To keep the battery fully charged, always keep the power cord connected to the AC outlet even when the defibrillator is not used.**
  - **Do not expose the battery pack to direct sunlight or leave in a high temperature place. The lifetime of the battery pack may be shortened, the performance of the battery may be degraded and the substance inside the battery may leak.**
  - **The battery pack must be inserted by a qualified service personnel.**
  - **Keep the battery pack away from children.**
  - **Before disposing of the battery, check with your local solid waste officials for details in your area for recycling options or proper disposal. The battery is recyclable. At the end of its useful life, under various state and local laws, it may be illegal to dispose of this battery into the municipal waste stream.**
- 
-

## Disposable Pads

---

---

### WARNING

- Failure to comply with the following warnings may cause serious skin burn or insufficient energy discharge and pacing current to the heart.
    - Do not reuse disposable pads. The pads are disposable.
    - If the pad package is broken, dispose of the pads and do not use them.
    - Do not use the pads if they are past the expiration date on the package.
    - Use the disposable pads as soon as possible after removing them from the package. Do not use a pad which is left for a long period of time after being removed from the package.
    - Do not use the disposable pads if the gel has become dry, or the gel breaks down and releases water.
    - Do not use the disposable pads if the color of the gel changes to dark brown and dark brown gel is on the protective liner.
  - If any pad or connector gets wet, replace it with a new one. If a wet pad or connector is used, it may cause electrical shock.
  - Replace the disposable pads after 1 hour pacing.
- 
- 

### CAUTION



- When using the disposable pads for long term ECG monitoring, replace them every 24 hours. Failure to follow this caution may cause insufficient pacing current and insufficient energy discharge to the heart.
  - Do not attach a disposable pad over another pad. Failure to follow this caution may cause serious skin burn.
  - Do not put heavy objects on the disposable pads or bend the pads. Otherwise the pads get damaged and deteriorated, resulting in skin burn on the patient.
- 
-

## Defibrillation, Cardioversion and AED

### General

---

#### WARNING

- Before defibrillation and cardioversion, make sure that no one is in contact with either the patient or any metal part of any equipment or cables which supports or is connected to the patient. Failure to follow this warning causes serious electrical shock or injury.
  - Before defibrillation and cardioversion, remove all electrodes, probes and transducers connected to a connector without a “” or “” mark from the patient. Otherwise the operator may get electrical shock and the connected instrument may be damaged.
  - Before defibrillation and cardioversion, move all electrodes and medicine on the patient’s chest to positions where the defibrillator paddle or disposable pad will not touch. If the defibrillator paddle or disposable pad directly touches electrodes or medicine, it causes skin burn on the electrode or medicine attachment site.
  - Do not carry or move the defibrillator when the charged energy remains in the defibrillator. If the defibrillator falls, it discharges energy and can cause electrical shock.
  - For this defibrillator, the CONTACT lamp on the STERNUM paddle indicates skin-paddle contact impedance. If the yellow or orange lamp lights, the defibrillator may cause serious electric burn on the patient’s skin and poor energy discharge to the patient. In case of an emergency, medical personnel should decide whether to execute discharge immediately, regardless of the CONTACT lamp display, or take action to make good contact before discharge.
  - Pay careful attention to the energy selection when using the pediatric electrode plates. Applying high energy with the pediatric electrode plates can cause serious electrical burn because the electrode plates are small.
  - Use the ECG monitoring electrodes (disposable electrodes) to monitor the ECG waveforms. Stable ECG cannot be acquired with the PADDLE lead because it is difficult to hold the paddles stable. ECG acquired from external paddles, internal paddles or disposable pads is unstable after discharge because of high polarization voltage.
  - Do not perform defibrillation or cardioversion in a wet place. Before defibrillation or cardioversion, move the patient and defibrillator to a dry place. Otherwise the operator may get electrical shock.
  - Do not discharge near a person or object other than the patient or test electrode plate or energy checker. It may cause electrical shock to the person or object.
  - Confirm that there is no artifact on the ECG. If there is artifact on the ECG, signals other than ECG are misrecognized to be QRS and accidental discharge may occur which is not synchronized with the patient’s QRS wave.
-

---

---

### WARNING continued

- Do not perform synchronized cardioversion with the PADDLE lead unless it is absolutely necessary. In synchronized cardioversion with the PADDLE lead, artifact may be misrecognized as QRS and accidental discharge may occur which is not synchronized with the patient's QRS wave.
- Never select "TEST" for the ECG lead. "TEST" is for maintenance and the waveform displayed on the screen is not the patient's ECG. If synchronized cardioversion is performed with the TEST lead, accidental discharge occurs which is not synchronized with the patient's QRS wave and it may cause ventricular fibrillation.
- If you use the ECG signal from the monitor, before cardioversion, check that the defibrillator discharge occurs within 60 ms of the peak of the ECG's R wave with a delivery checker. If this condition is not met, the cardioversion may be ineffective or may cause ventricular fibrillation.
- The apex-posterior placement is not suitable for ECG monitoring or AED analysis.
- The anterior-posterior placement is not suitable for defibrillation, cardioversion, ECG monitoring or AED analysis. Use this placement only for pacing.

---

---

### CAUTION

When performing synchronized cardioversion, confirm that the SYNC lamp is lit before every discharge. If "Sync mode after CV" is set to Defib on the System Setup-Configuration screen, the defibrillator automatically turns to the asynchronous defibrillation mode.

---

---

### With External Paddles

---

---

### WARNING

- Apply contact gel only to the electrode plates of the external paddles. If contact gel gets on any other part of the defibrillator, it may cause electrical shock to the operator.
  - Do not apply contact gel by hand. Failure to follow this warning may cause serious electrical burn, shock, or other injury.
  - Do not grasp the paddle handles with the wet hand or the hand with contact gel attached. Failure to follow this warning may cause electrical shock to the operator.
  - Apply contact gel to the electrode plates of the external paddles. Failure to apply contact gel causes serious skin burn.
  - Do not touch the electrode plate or edge of the paddle. Failure to follow this warning may cause serious electrical burn, shock, or other injury.
- 
-

---

---

**WARNING continued**

- When charging or discharging, do not touch anything other than the handles. Failure to follow this warning causes electrical shock to the operator.
  - Before discharging, confirm that the paddles are firmly pressed against the chest wall. Failure to follow this warning causes serious skin burn or poor energy discharge to the heart.
  - Do not perform open discharge into the air. This may cause electrical shock to the operator or damage the defibrillator.
  - Do not discharge the energy if the paddles are shorted to each other by contact gel. Failure to follow this warning causes serious electrical burn and poor energy discharge to the heart.
- 
- 

**CAUTION**

- If the patient's body is wet, thoroughly wipe the moisture off the skin so that the paddles do not short to each other.
  - Do not discharge when the paddles touch each other. This may damage the defibrillator.
- 
- 

**With Disposable Pads**

---

---

**WARNING**

- Do not attach pads on the papilla, electrodes or medicine on the patient's body. Failure to follow this warning causes serious skin burn.
  - Fit the pad closely to the body surface so that current flows uniformly through the pad. Failure to follow this warning causes serious skin burn or insufficient energy discharge to the heart.
  - During charging or discharging, do not touch the pads or connectors. Failure to follow this warning causes electrical shock to the operator.
  - Before discharging, confirm that the pads are firmly applied to the chest wall. Failure to follow this warning causes serious skin burn or poor energy discharge to the heart.
  - Do not discharge if the pads overlap each other or if the pads are shorted to each other by anything conductive such as contact gel. Failure to follow this warning causes serious electrical burn and poor energy discharge to the heart.
- 
-

---

---

### CAUTION

- When connecting the pad adaptor to the paddle connector, do not bend or damage the connector pin. Otherwise energy cannot be discharged to the pads.
  - If the patient's body is wet, thoroughly wipe the moisture off the skin so that the pads do not short to each other.
- 
- 

#### With Internal Paddles

---

---

### WARNING

- Always sterilize the internal paddles before use. Failure to follow this warning may cause serious infection.
  - Pay careful attention to the energy selection when using internal paddles. Applying high energy to the heart may cause cardiac muscle necrosis. Low energy is recommended.
  - During charging and discharging, grip the internal paddles between the guard at the top of the handle and the cable. If you grip the handle between the electrode and the guard, you may get an electrical shock.
  - Before discharging, confirm that the paddles are firmly positioned against the heart. Failure to follow this warning causes serious skin burn or poor energy discharge to the heart.
  - Do not perform open discharge into the air. This may cause electrical shock to the operator or damage the defibrillator.
- 
- 

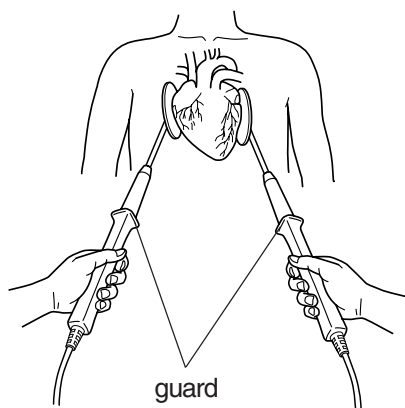

---

---

### CAUTION

- Do not twist the internal paddle holding the electrode part or give strong impact to the paddle. It damages the electrode part.
  - When connecting the internal paddles to the paddle connector, do not bend or damage the connector pin. Otherwise energy cannot be discharged to the paddles.
  - Do not discharge when the paddles touch each other. This may damage the defibrillator.
- 
-

**AED**

---

---

**WARNING**

- Do not attach pads on the papilla, electrodes or medicine on the patient's body. Failure to follow this warning causes serious skin burn.
  - Fit the pad closely to the body surface so that current flows uniformly through the pad. Failure to follow this warning causes serious skin burn or insufficient energy discharge to the heart.
  - When you perform defibrillation in an ambulance, stop the car.
  - During charging or discharging, do not touch the pads or connectors. Failure to follow this warning cause electrical shock to the operator.
  - Before discharging, confirm that the pads are firmly applied to the chest wall. Failure to follow this warning causes serious skin burn or poor energy discharge to the heart.
  - Do not discharge if the pads overlap each other or if the pads are shorted to each other by anything conductive such as contact gel. Failure to follow this warning causes serious electrical burn and poor energy discharge to the heart.
- 
- 

**CAUTION**

- Before AED analysis or defibrillation, confirm that the patient is unconscious and has no respiration and no pulse.
  - The ECG of a child or a patient with a implanted pacemaker cannot be analyzed correctly. For these patients, follow the physician's instruction.
  - During AED analysis, do not touch or move the patient, pad adaptor and disposable pad cable. Stop the life saving treatment such as CPR. Otherwise, correct analysis result cannot be obtained. If the ECG baseline is wandering because of surrounding conditions, measurement conditions or electrode conditions, remove the causes before performing AED analysis.
  - When connecting the pad adaptor to the paddle connector, do not bend or damage the connector pin. Otherwise energy cannot be discharged to the pads.
  - If the patient's body is wet, thoroughly wipe the moisture off the skin so that the pads do not short to each other.
  - Do not discharge when the paddles touch each other. This may damage the defibrillator.
- 
-

---

---

## WARNING

- Do not perform pacing while using an ESU. Before using an ESU, turn the defibrillator power off and remove disposable pads from the patient. Otherwise, high frequency energy from the ESU causes abnormal current to flow in the patient and causes serious electrical burn, shock, or other injury. It also damages the defibrillator.
  - Always monitor the ECG waveform with the ECG connection cable and ECG electrodes.
  - Confirm that there is no artifact on the ECG. If there is artifact on the ECG, signals other than ECG are misrecognized to be QRS and correct pacing cannot be performed.
  - Do not touch the patient during pacing. Failure to follow this warning may cause electrical shock.
  - During pacing, do not touch the pads or connectors. Failure to follow this warning causes electrical shock to the operator.
  - The pacing rate must be determined by qualified medical personnel based on the heart rate of the patient in a normal state.
  - The pacing current must only be increased by qualified medical personnel decision.
  - Keep the current intensity as low as possible to minimize pain and discomfort to the patient.
  - Failure to follow the following warnings causes serious skin burn.
    - Do not attach the pads over ECG electrode.
    - Do not attach pads on the papilla or medicine on the patient's body.
    - Fit the pad closely to the body surface so that current flows uniformly through the pad. This reduces the required pacing current and pain and discomfort to the patient.
  - The apex-posterior placement is not suitable for ECG monitoring or AED analysis.
  - The anterior-posterior placement is not suitable for defibrillation, cardioversion, ECG monitoring or AED analysis. Use this placement only for pacing.
  - Never select "TEST". "TEST" is for maintenance and the waveform displayed on the screen is not the patient's ECG. Failure to follow this warning causes accidental pacing which is not synchronized with the patient's QRS wave.
  - Do not change the sensitivity or ECG lead setting after pacing is started. If one of these settings is changed, the pacing stops for 3 seconds. Failure to follow this warning may cause serious heart attack.
  - For 300 ms after the pacing pulse is output, no signal can be detected as a QRS wave.
- 
-



---

---

### CAUTION

- Check that the pacing pulse is effectively working by observing ECG on the screen.
  - When connecting the pad adaptor to the paddle connector, do not bend or damage the connector pin. Otherwise energy cannot be discharged to the pads.
  - If the patient's body is wet, thoroughly wipe the moisture off the skin so that the pads do not short to each other.
- 
- 

## ECG Monitoring

---

---

### WARNING

- When using a defibrillator together with the monitor, use Ag/AgCl electrodes. Other types of electrodes, stainless steel in particular, will adversely affect the ECG waveform by slowing the baseline recovery on the monitor and result in no monitoring immediately following defibrillation.
  - False low heart rate indicators may occur with certain pacemakers because of electrical overshoots.
  - Keep pacemaker patients under close observation. The pacemaker rate may be counted during cardiac arrest and certain arrhythmias. Do not rely only on heart rate alarms and the displayed heart rate.
  - The apex-posterior placement is not suitable for ECG monitoring or AED analysis.
  - The anterior-posterior placement is not suitable for defibrillation, cardioversion, ECG monitoring or AED analysis. Use this placement only for pacing.
  - With the pacing pulse rejection ON, narrow width QRS of a premature baby or infant cannot be detected correctly and the defibrillator may miscount QRS. In this case, set the pacing pulse rejection to OFF.
  - Turn the pacing pulse rejection to OFF when monitoring a child. Otherwise child's QRS may not be recognized.
- 
- 

---

---

### CAUTION

- When the "Check ECG Electrodes" message is displayed, ECG cannot be monitored and the ECG alarm does not function. Check the electrode, ECG connection cable, electrode leads and connection cable and if necessary, replace it with a new one.
  - Turn the pacing pulse rejection to ON when monitoring a pacemaker patient. Otherwise QRS and pacemaker spike may not be distinguished and pacemaker failure may not be recognized.
- 
-

## SpO<sub>2</sub> Monitoring

---

---

### WARNING

- Measurement may be incorrect in the following cases.
    - increases abnormally
    - When dye is injected in the blood
    - When using an electrical surgery unit
    - During CPR
    - When there is body movement
    - When there is vibration
    - When measuring at a site with venous pulse
    - When the pulse wave is small (insufficient peripheral circulation)
    - When using an IABP (intra-aortic balloon pump)
  - When not monitoring SpO<sub>2</sub>, disconnect the SpO<sub>2</sub> adapter cable from the defibrillator. Otherwise, noise from the probe sensor may interfere and incorrect data is displayed on the screen.
- 
- 

---

---

### CAUTION

- Only use the specified probes. Otherwise SpO<sub>2</sub> cannot be monitored properly and defibrillator performance may be degraded.
  - If the “Check SpO<sub>2</sub> unit”, “Check SpO<sub>2</sub> probe site”, “SpO<sub>2</sub> probe not working”, “SpO<sub>2</sub> module not working” or “SpO<sub>2</sub> measurement unstable” message appears frequently even when the probe is attached on a site with appropriate thickness, the probe is deteriorated. Replace the probe with a new one.
  - When error messages which indicate faulty probe or SpO<sub>2</sub> adapter appear, stop monitoring and replace the probe or SpO<sub>2</sub> adapter with a new one.
- 
- 

## CO<sub>2</sub> Monitoring

---

---

### WARNING

- When performing defibrillation or cardioversion during CO<sub>2</sub> monitoring with the CO<sub>2</sub> sensor kit, remove the sensor from the patient. When the sensor cannot be removed, do not touch the sensor cable because the discharged energy may cause serious electrical burn, shock or other injury.
  - Before MRI examination, remove the CO<sub>2</sub> sensor kit from the patient. Failure to follow this warning may cause serious electrical burn on the patient due to local heating caused by dielectric electromotive force. For details, refer to the MRI operator’s manual.
- 
-

---

---

### CAUTION

- The measurement may be inaccurate when a patient with an extremely high respiration rate or patient with irregular respiration is monitored. Read the measured values carefully.
  - Measured value may be incorrect when the operating temperature changes greatly.
  - When the “CO<sub>2</sub> sensor not working” or “CO<sub>2</sub> adapter abnormality” message is displayed, check the CO<sub>2</sub> sensor kit and replace it if necessary. CO<sub>2</sub> cannot be monitored while the message is displayed.
  - Only use the specified CO<sub>2</sub> sensor kit. Otherwise CO<sub>2</sub> cannot be monitored properly and defibrillator performance may be degraded.
  - Obey the CAUTION label on the CO<sub>2</sub> gas cylinder.
  - After the lifetime of the CO<sub>2</sub> gas cylinder expires, the measurement accuracy cannot be guaranteed.
- 
- 

## Alarms

---

---

### WARNING

All alarms except for instrument alarm group 1 are suspended during two minutes alarm suspension.

---

---

---

---

### CAUTION

- When the alarm limit is set to OFF, there will be no alarm for that limit. Be careful when you set the alarm to OFF.
  - Alarms about a parameter do not occur until the measurement of the parameter starts.
- 
- 

## Maintenance

---

---

### WARNING

- When performing energy discharge test, discharge the energy with the paddles kept in the paddle holders. Do not discharge with the paddle released in the air or when the paddles are shorted. Failure to follow this warning may cause serious electrical shock and damage to the defibrillator.
  - If defibrillation or cardioversion is necessary during battery test, cancel the battery test and operate the defibrillator on AC power. Do not use battery power because the battery may have been discharged by the battery test.
- 
-

---

---

**CAUTION**

- **Before maintenance (cleaning, disinfection), turn the defibrillator power off, disconnect the power cord from the AC outlet and then remove the battery from the defibrillator. Failure to follow this caution may result in electrical shock and defibrillator malfunction.**
  - **Before battery replacement, turn off the defibrillator power and disconnect the AC power cord from the defibrillator. Otherwise, the operator may get an electrical shock.**
  - **Do not disassemble or repair the defibrillator. Disassembly and repair must be performed by qualified service personnel.**
- 
- 

**Storage**

---

---

**CAUTION**

- **To prevent overheating, leave the defibrillator lying flat and do not cover it.**
  - **Store the disposable pads in an environment described on the pads package. If stored in an environment other than specified, the pads become unusable.**
- 
-

## Specifications

### Defibrillator

Output energy (across 50 $\Omega$ )	2, 3, 5, 7, 10, 15, 20, 30, 50, 70, 100, 150, 200 and 270 J
Energy accuracy	2 J: $\pm 0.5$ J
	3 J: $\pm 1$ J
	5 to 15 J: $\pm 2$ J
	20 to 270 J: $\pm 10\%$
Output waveform	Biphasic, truncated exponential constant power (across 50 $\Omega$ )
Charging time	When powered by AC 100V to 240V: to 270 J, maximum 5 s to 200 J, maximum 3 s
	When powered by 90% of the rated mains voltage: to 270 J, maximum 5 s
	When powered by a fully charged new battery at 20°C ambient temperature: to 270 J, maximum 5 s to 200 J, maximum 3 s
	After 15 discharges at 270 J with a fully charged new battery at 20°C ambient temperature: to 270J, maximum 5 s
Charging display	Displays the charged energy value on the screen
Synchronized discharge	Available
	From the peak of R wave to the peak of discharge: within 60 ms
Maximum continuous charge/discharge cycles at 270 J	20 cycles: 3 cycles per minute with 1 minute cool down period after every 1 minute charge/discharge period
	15 cycles: 3 cycles per minute with no cool down period

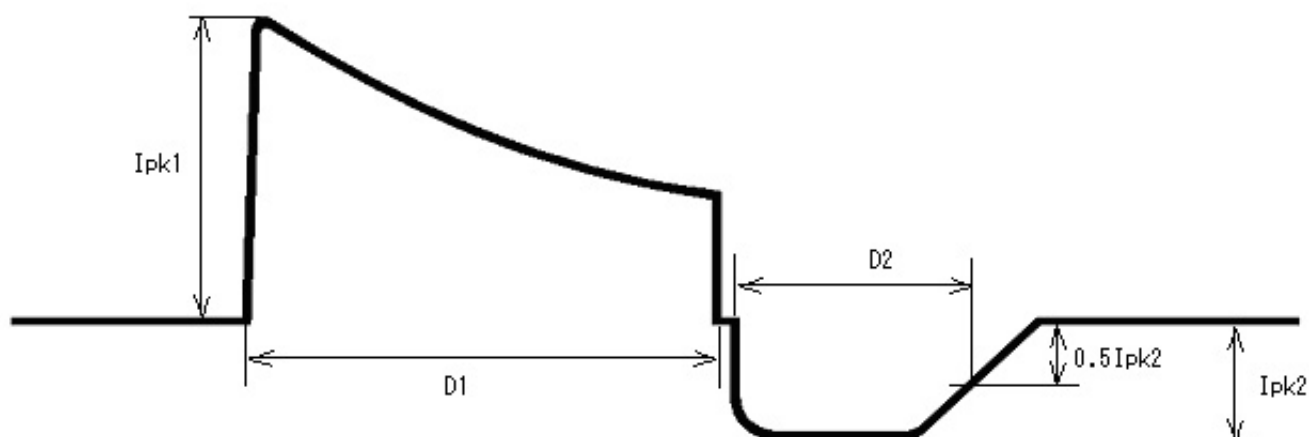

Load resistance ( $\Omega$ )	First phase		Second phase	
	Ipk1 (A)	D1 (ms)	Ipk2 (A)	D2 (ms)
25	67.3	3.85	15.5	3.62
50	41.1	6.35	12.7	3.62
75	29.5	8.86	11.0	3.62
100	22.9	11.4	9.81	3.62
125	18.8	13.9	8.96	3.62
150	15.9	16.4	8.29	3.62
175	13.8	18.9	7.76	3.62

# 1. GENERAL

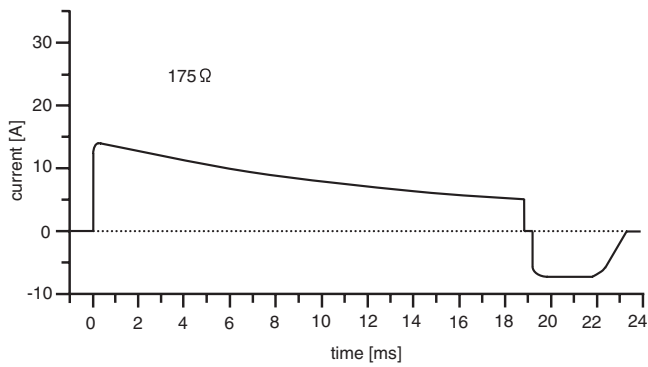
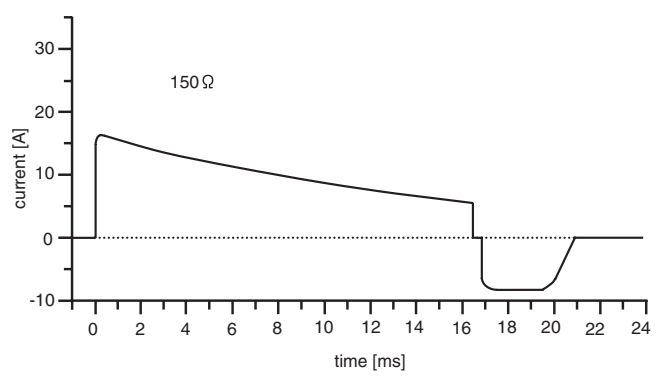
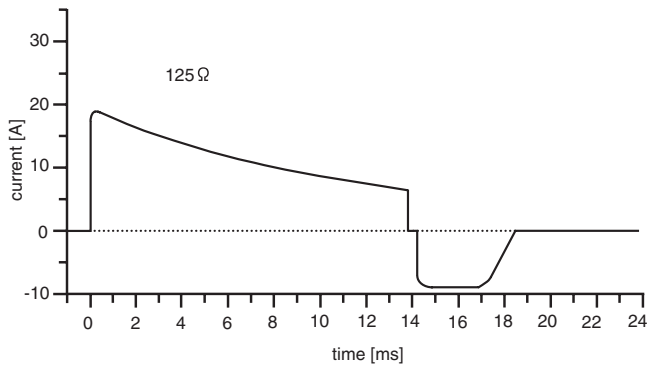
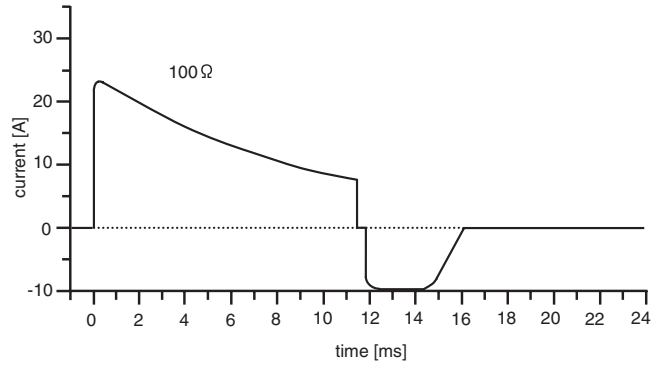
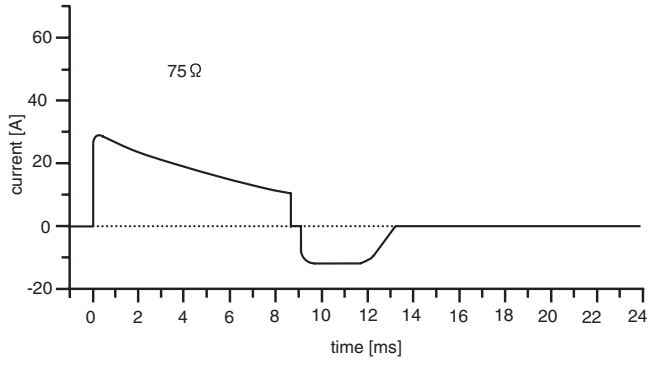
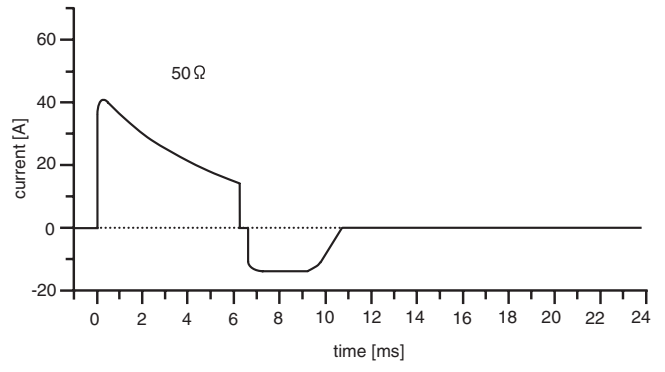
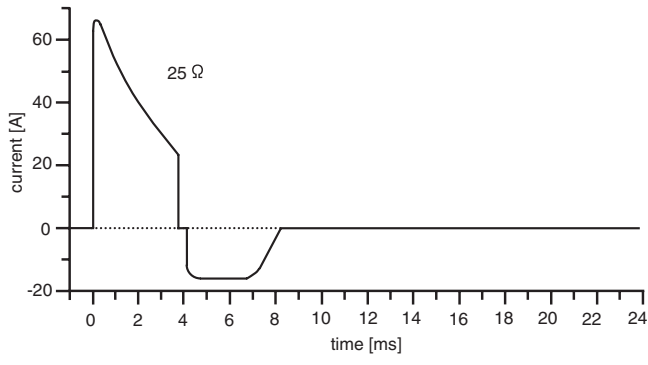

**Noninvasive Pacing (TEC-5531 series only)**

Pacing rate	30 to 180 pulse/min in 10 pulse/min steps
Output current	8 to 200 mA in 5 mA steps (Set on the System Setup screen)
Pacing modes	Fixed and Demand
Maximum load resistance	Outputs 200 mA across 250 $\Omega$ , 120 mA across 500 $\Omega$

**External Paddle (ND552VC/VE/VK)**

Paddle electrode size	For adults: 70 $\pm$ 3 $\times$ 106 $\pm$ 3 (mm <sup>2</sup> ) For children: 45 $\pm$ 3 $\times$ 53 $\pm$ 3 (mm <sup>2</sup> )
Paddle cord length	2.0 m or more (when it is pulled by 18 N force)

**Battery**

Type	Ni-MH battery
	Nominal voltage: 12 V
	Rated capacity: 2800 mAh

TEC-5521/5531 series:	With fully charged new battery at 20°C ambient temperature
	- Minimum 70 discharges at 270 J
	- Minimum 150 minutes continuous monitoring
	- Minimum 90 minutes fixed mode pacing (180 pulse/min, 200 mA)
	With the fully charged new battery at 0°C, the defibrillator can perform:
	- Minimum 50 discharges at 270 J

**Clock Accuracy**

At surrounding temperature 25°C (77°F):	$\pm$ 3 min/month
At storage temperatures -20 to 70°C (-4 to 158°F):	$\pm$ 5 min/month

**Environment**

Operating temperature:	0 to 45°C (32 to 113°F)
Operating humidity:	30 to 95% (relative humidity, non-condensing)
Operating atmospheric pressure:	70 to 106 kPa (Recording paper may jam, if it is wet.)
Storage temperature:	-20 to 70°C (-4 to 158°F)
Storage humidity:	10 to 95% (relative humidity, non-condensing)
Storage atmospheric pressure:	50 to 106 kPa

**Electromagnetic Compatibility**

IEC 60601-1-2: 2001
IEC 60601-2-4: 2002

## 1. GENERAL

### Safety

Safety standard	IEC 60601-1: 1988 IEC 60601-1 Amendment 1: 1991 IEC 60601-1 Amendment 2: 1995 IEC 60601-2-4: 2002
According to the type of protection against electrical shock	
Battery power:	INTERNALLY POWERED EQUIPMENT
AC power:	CLASS I EQUIPMENT
According to the degree of protection against electrical shock	DEFIBRILLATION-PROOF TYPE BF APPLIED PART: External paddles, disposable pads, SpO <sub>2</sub> adapter and CO <sub>2</sub> sensor kit DEFIBRILLATION-PROOF TYPE CF APPLIED PART: Internal paddles, ECG connection cable
According to the degree of protection against harmful ingress of water:	IPX1
According to the degree of safety of application in the presence of a FLAMMABLE ANAESTHETIC MIXTURE WITH AIR, OR WITH OXYGEN OR NITROUS OXIDE:	EQUIPMENT not suitable for use in the presence of FLAMMABLE ANAESTHETIC MIXTURE WITH AIR, OR WITH OXYGEN OR NITROUS OXIDE
Mode of operation	Continuous operation with intermittent load: Operation at defibrillation mode Continuous operation: All operation except above mentioned

### Monitor

Effective display area	117.2(W) × 88.4(H) mm (5.7 inch)
Sweep length	97 mm
Sweep speed	25 mm/s, 50 mm/s
Sensitivity	10 mm/1mV ±5% (sensitivity × 1)
Amplitude limit	40 mm

### ECG Amplifier

Input signal	PADDLE, I, II, III, aVR, aVL, aVF, V, AUX
Frequency response	Through paddles: 0.5 to 20 Hz (-3 dB) Through ECG connection cable: 0.05 to 150 Hz (-3 dB), at AC filter off AUX: 0.05 to 150 Hz (-3 dB)
Input impedance	Through paddles: ≥100 kΩ Through ECG connection cable: ≥5 MΩ (at 10 Hz 1mV) AUX: ≥ 100 kΩ
CMRR	≥100 dB (against chassis ground) at AC filter On
AC filter	Available (common with 50/60 Hz) ON at ≥-20 dB, OFF
Pacing pulse rejection	ON, OFF
External ECG input sensitivity	10 mm/V ± 5% (sensitivity × 1)
Heart rate counting range	Defibrillation or monitoring mode: 15 to 300 bpm Pacing mode: 15 to 220 bpm



**Recorder**

Paper speed	Real time/delayed ECG waveform recording: 50, 25 mm/s
Types of recording	Manual recording: real time/delayed waveform recording, report recording, event recording Automatic recording: record on charging after discharge, alarm recording, periodic recording

**Rhythm Recognition Detector**

We evaluated the rhythm recognition detector of the TEC-5500 series defibrillator using the official electrocardiogram database provided by AHA (American Heart Association) and MIT (Massachusetts Institute of Technology) and an electrocardiogram database of over 3000 electrocardiograms from hospitals in Japan. According to our own evaluation, the rhythm recognition detector of the TEC-5500 series defibrillator meets the equivalent of AAMI standards ANSI/AAMI DF-39-1993 3.3.18.

**Power Requirements**

## AC

Line voltage:	100 to 240 V
Line frequency:	50/60 Hz (automatic switching)
Power input:	Intermittent load: 450 VA or less Continuous load: 200 VA or less

## DC (Battery)

Power voltage:	12V
Power consumption	Intermittent load, 18A or less
Continuous load:	4.2 A or less
Charging time:	3 hours or less

**Dimensions and Weight**

Dimensions 290 (W) × 172 (H) × 355 (D) mm

## Weight

TEC-5521 series defibrillator	6.1 kg (External paddles use, AC unit without battery)
	5.3 kg (Pad adaptor use, AC unit without battery)
TEC-5531 series defibrillator	6.3 kg (External paddles use, AC unit without battery)
	5.5 kg (Pad adaptor use, AC unit without battery)

# Panel Description

## Front Panel

\* When DSI interface unit is connected

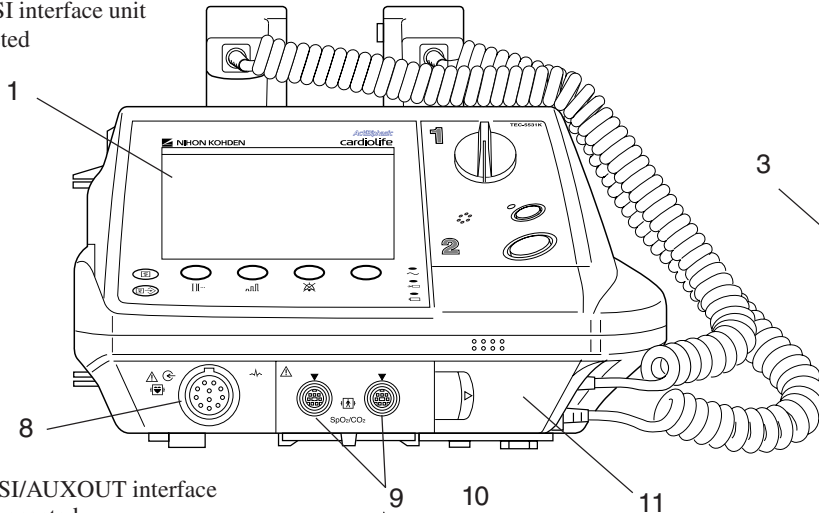

\* When DSI/AUXOUT interface unit is connected

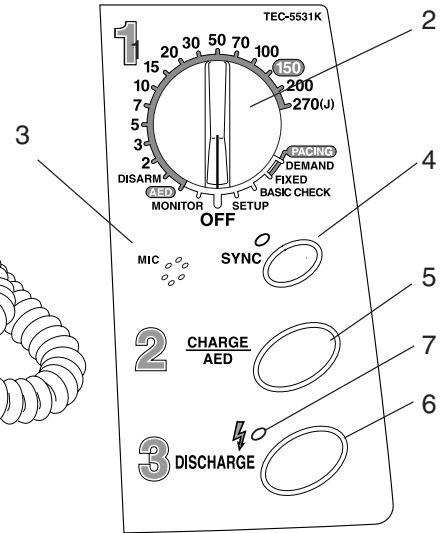
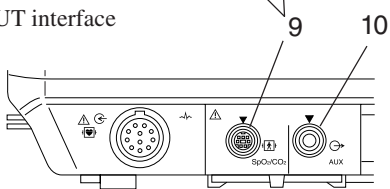

### Name

- 1 LCD display
- 2 Energy/Mode Select control
- 3 Microphone
- 4 SYNC button/lamp
- 5 CHARGE/AED button
- 6 DISCHARGE button
- 7 DISCHARGE lamp
- 8 ECG input connector
- 9 SpO<sub>2</sub>/CO<sub>2</sub> connector
- 10 AUXOUT connector
- 11 Paddle connector

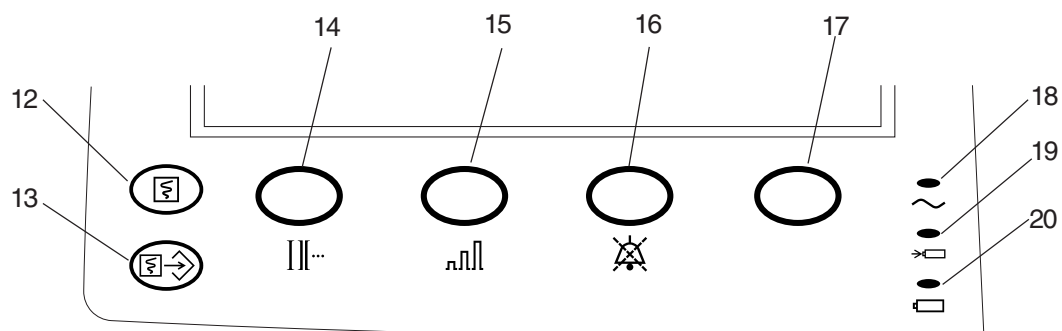

No.	Name
12	Record key
13	Event key
14	ECG lead key
15	ECG sensitivity key
16	Silence alarms key
17	Multi-function key
18	AC lamp
19	Battery charging lamp
20	Battery charge complete lamp

**Top Panel (TEC-5531 Series Only)**

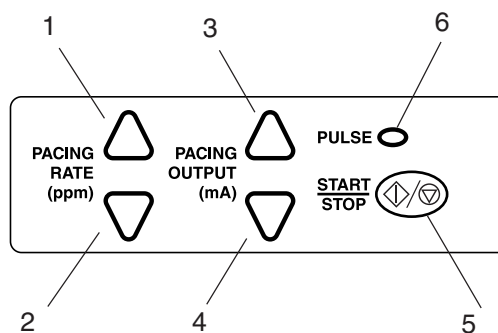

No.	Name
1	PACING RATE Up key
2	PACING RATE Down key
3	PACING OUTPUT Up key
4	PACING OUTPUT Down key
5	START/STOP key
6	PULSE lamp

## 1. GENERAL

### External Paddles

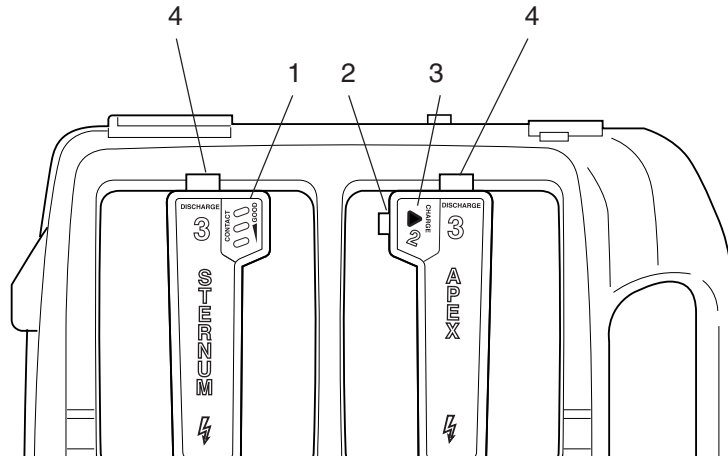

#### Name

- 1 CONTACT lamp
- 2 CHARGE button
- 3 CHARGE lamp
- 4 DISCHARGE buttons

### Left Side Panel

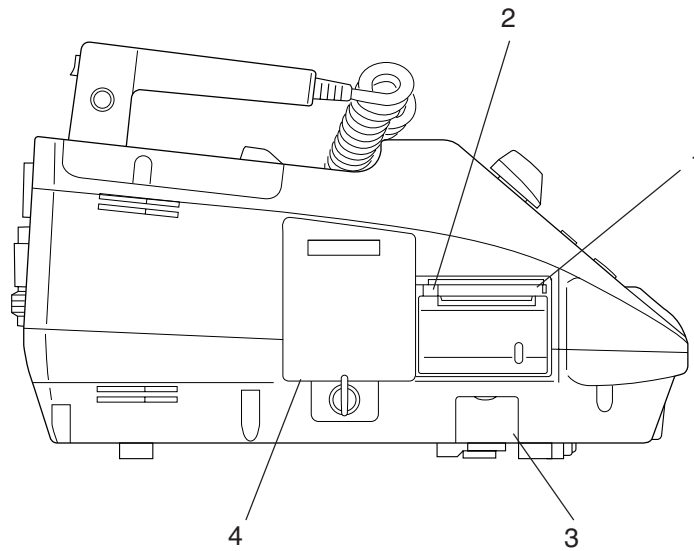

#### Name

- 1 Recording paper exit
- 2 Door release lever
- 3 SD card slot
- 4 Battery pack holder

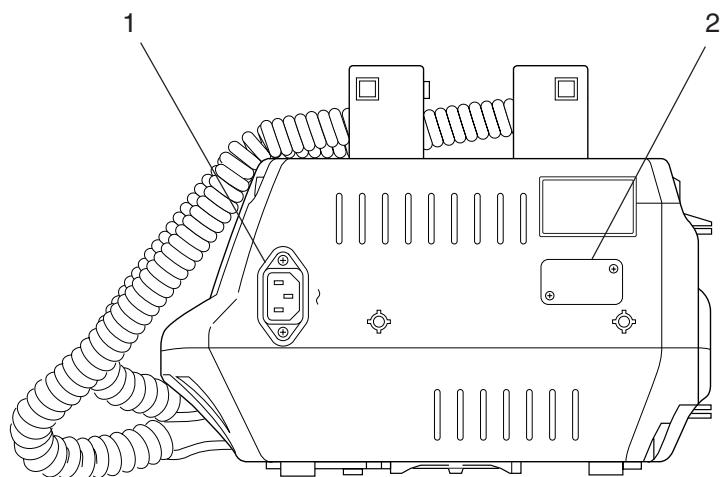
**Rear Panel****Name**

- 1 AC SOURCE socket
- 2 Optional unit connector

# Composition

## Standard Components

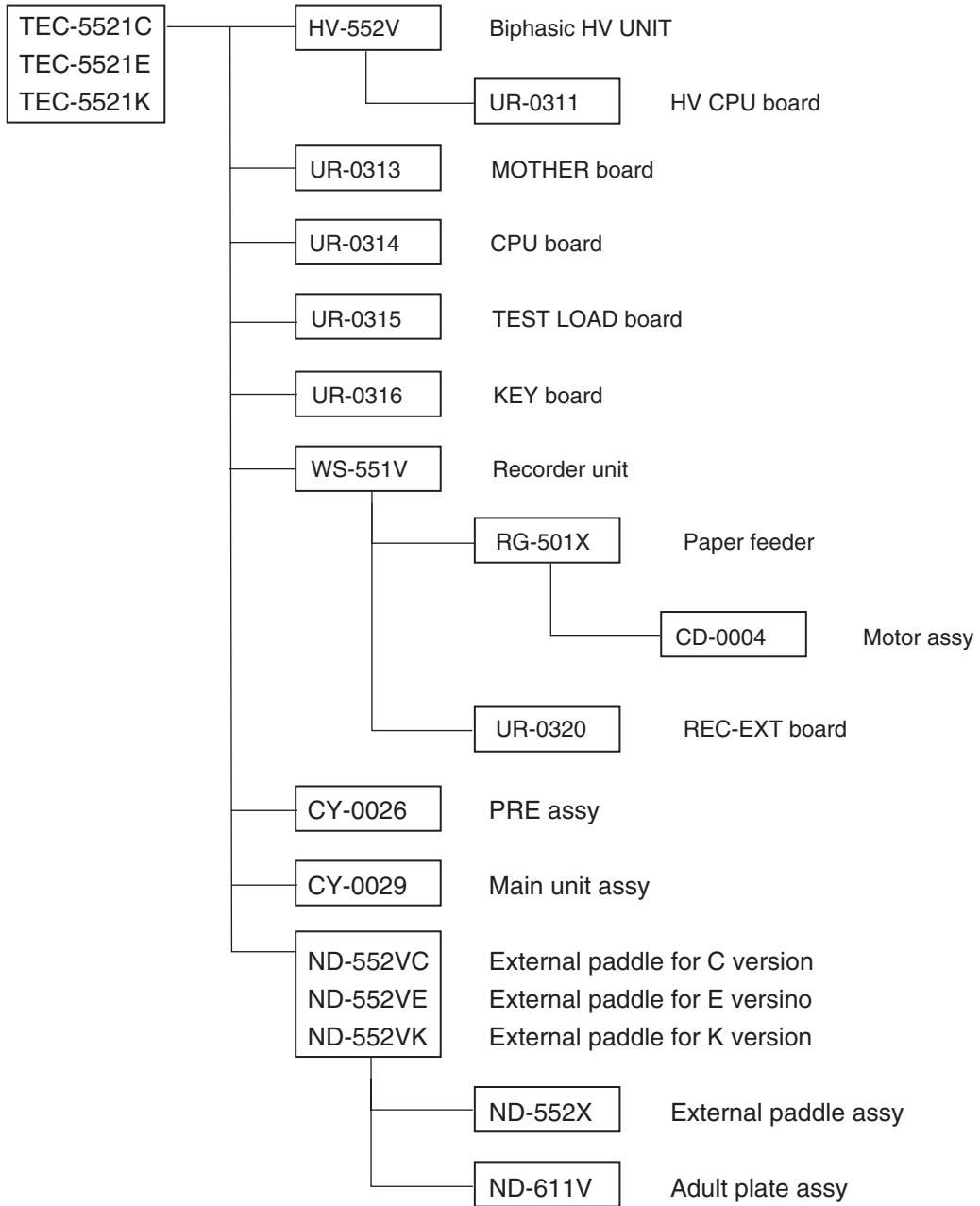

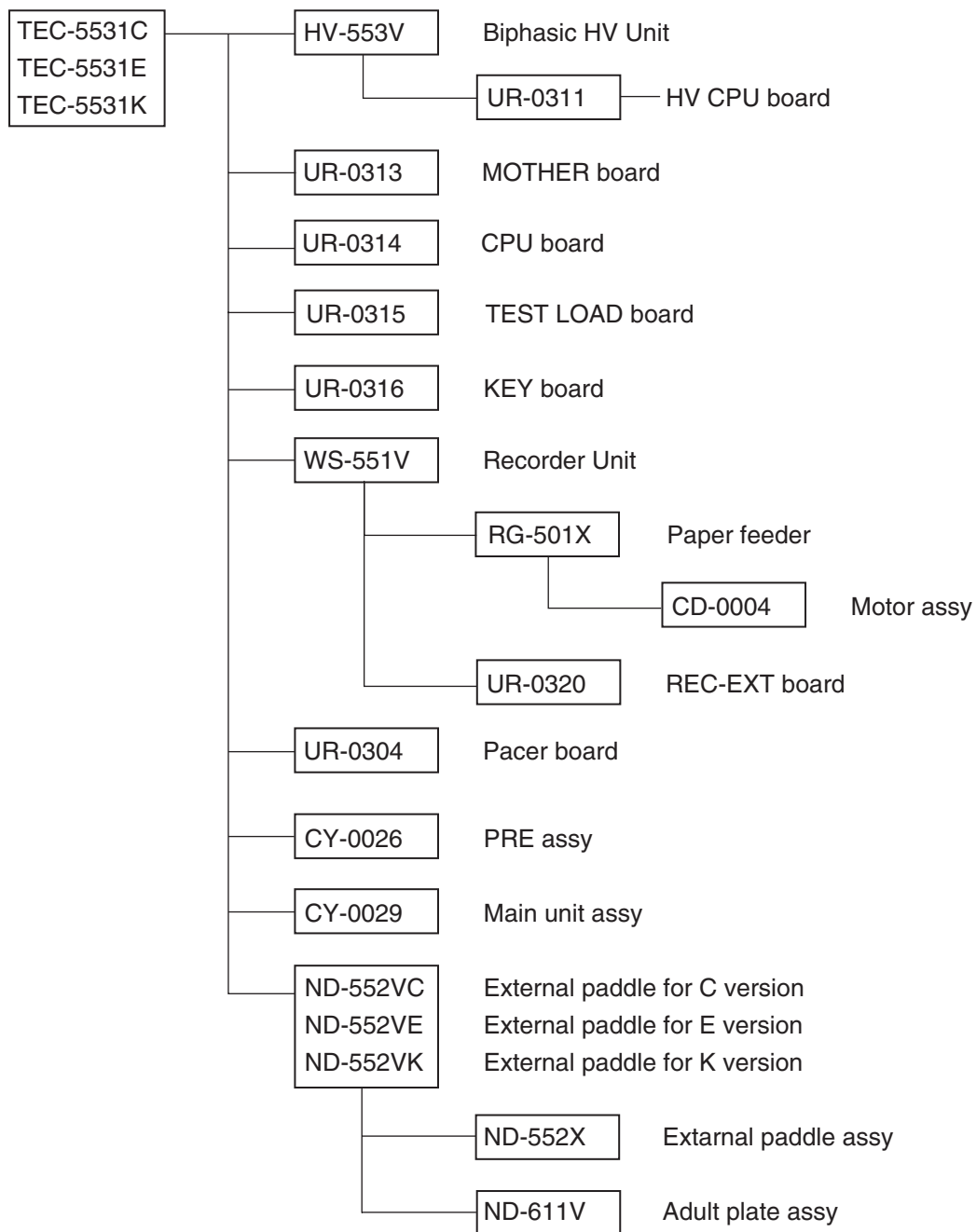

**Options**

JC-761V	External ECG cable
JC-762V	Connection cable
JC-763V	Connection cable
ND-612V	Pediatric electrode, 44 mm $\phi$
ND-762V	Internal paddle electrode, 25 mm $\phi$
ND-763V	Internal paddle electrode, 35 mm $\phi$
ND-764V	Internal paddle electrode, 45 mm $\phi$
ND-765V	Internal paddle electrode, 55 mm $\phi$
ND-766V	Internal paddle electrode, 65 mm $\phi$
ND-767V	Internal paddle electrode, 75 mm $\phi$
BC-765V	ECG connection cable (IEC, 5 leads)
BC-765VA	ECG connection cable (AHA, 5 leads)
JC-755V	Pad adapter
JC-765V	Pad adapter
KD-028A	Cart
DI-001A	Cart tray assembly
YZ-024H9	Battery pack, NKB-301V
YZ-025H0	Paste holder kiy



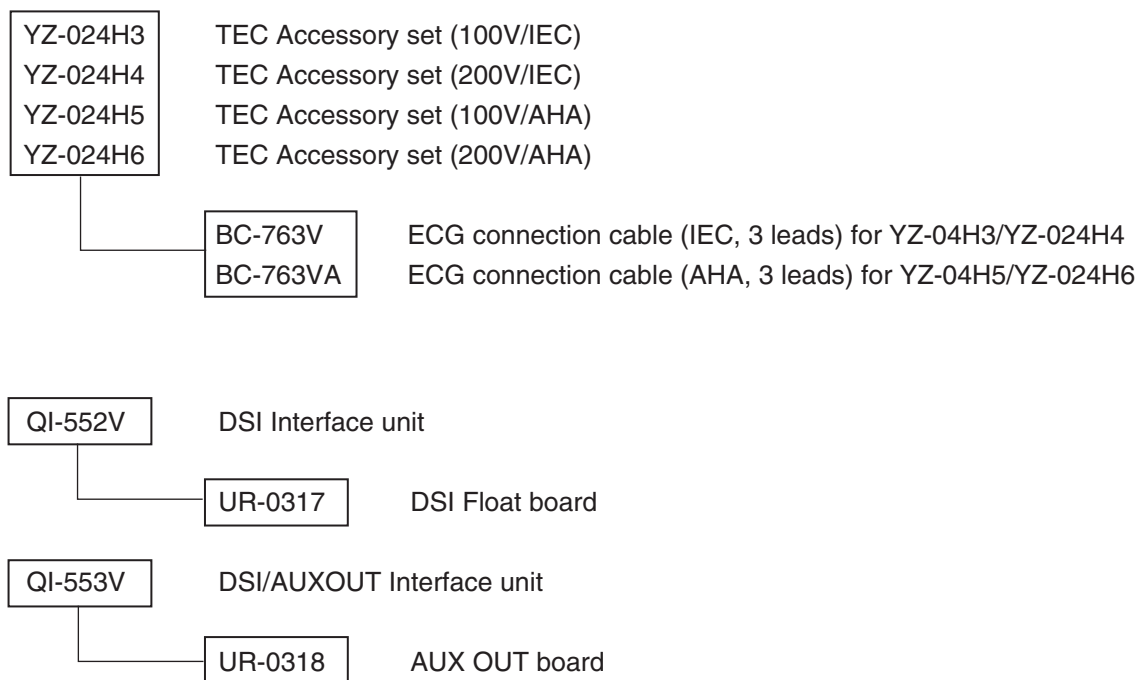

## Board/Unit Location

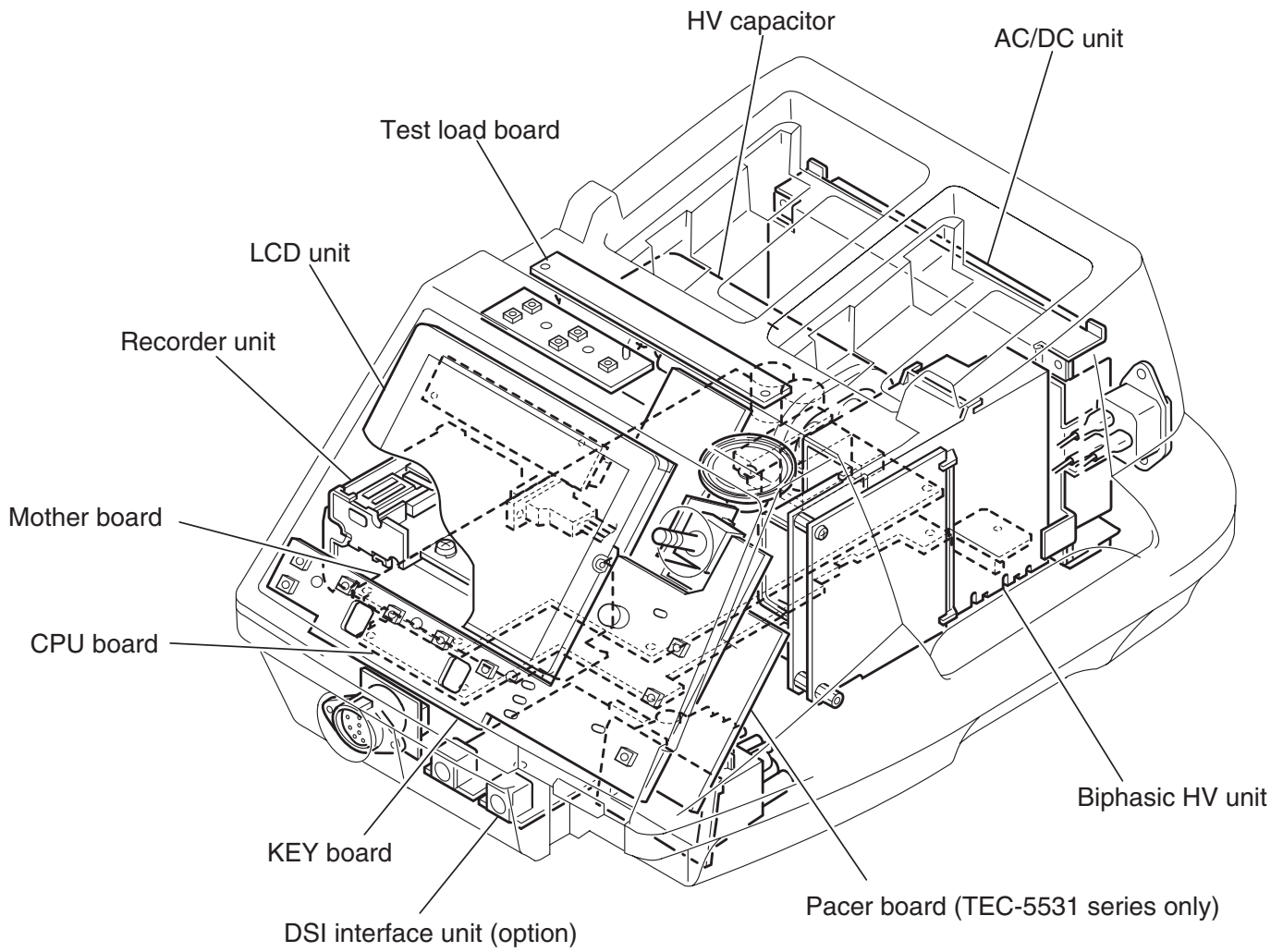

# Block Diagram

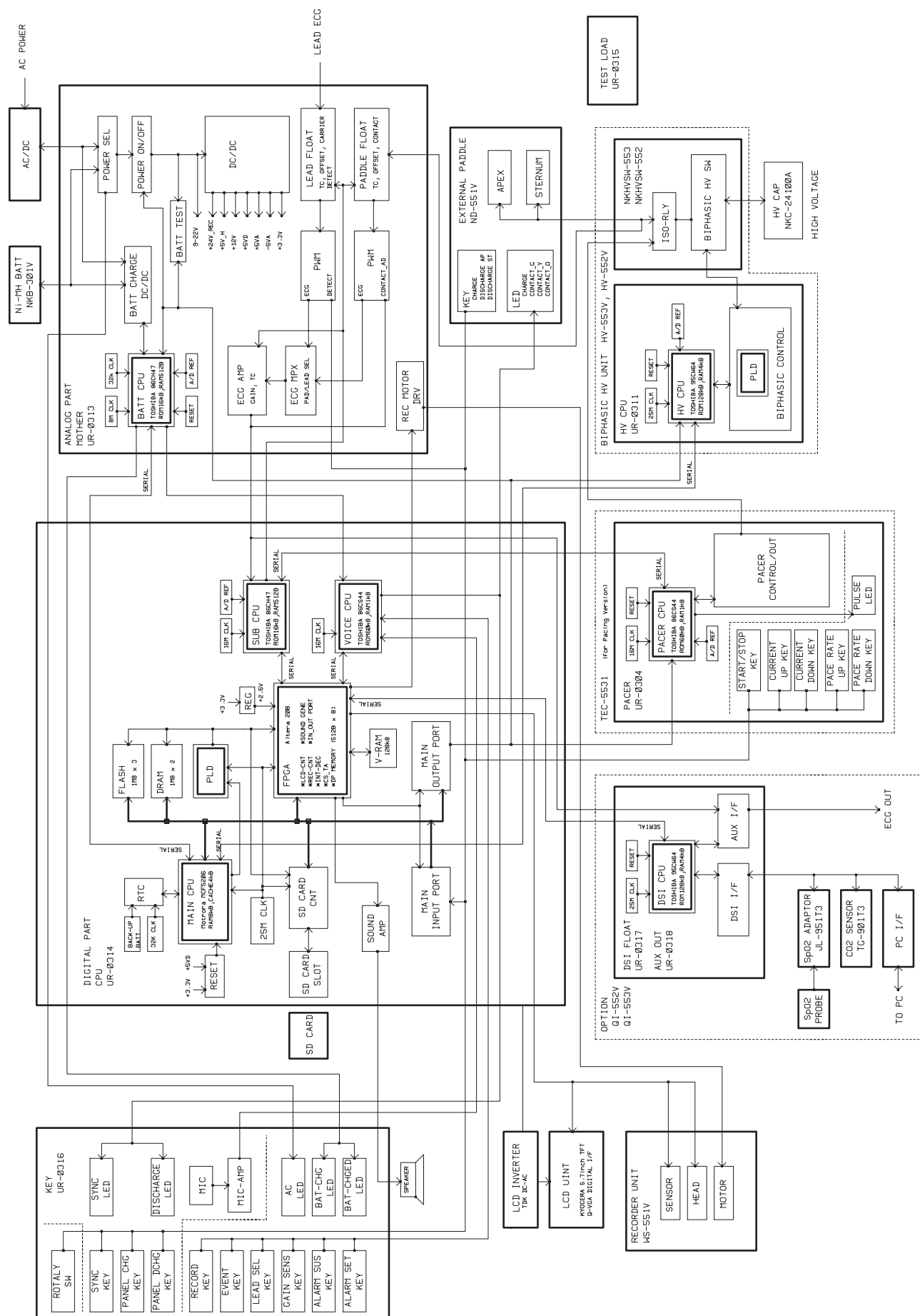

**This page is intentionally left blank.**

# *Section 2 Troubleshooting*

How to Troubleshoot .....	2.1
Error Code .....	2.2
Defibrillation .....	2.3
Operation Panel .....	2.4
Communication .....	2.5
Data Error .....	2.6
Pacing (TEC-5531 Series Only) .....	2.6
Message .....	2.7
Troubleshooting .....	2.9
General .....	2.9
Defibrillation .....	2.10
Monitoring .....	2.11
Recording .....	2.13
Battery .....	2.13
Pacing (TEC-5531 Series Only) .....	2.14

**This page is intentionally left blank.**

## How to Troubleshoot

Use this section to locate, identify and solve a problem in the defibrillator or an error message displayed on the screen. The troubleshooting tables in this section are divided into general problems and displayed error messages.

1. Determine which troubleshooting table to use. Also refer to “Messages and Troubleshooting” in Section 10 of the Operator’s manual.
2. In the “Error Code”, “Message” or “Problem” column, find the trouble item that matches the problem or error message.
3. Do the action recommended in the “Action” column. (Do the first action recommended in the “Action” column).
4. If the problem or error message is not solved, do the next action recommended in the “Action” column. (If this does not solve the problem, do the next recommended sections.)
5. If none of the actions solve the problem, contact your Nihon Kohden distributor or representative.

### NOTE

**Before contacting your NK distributor or representative for technical support, please complete a copy of the Maintenance Check Sheet (the original copy is provided at the end of the Section 4 “Maintenance”), and if possible, provide additional detailed information on the problem. Send the complete copy of the Maintenance Check Sheet to your NK distributor or representative. This will allow your NK distributor or representative to provide you with the best support.**

## Error Code

The defibrillator displays an error code if it detects an error when the power is turned on and during operation.

### NOTE

- For problems that are not reproducible, call up the System Setup screen and print the REPORT HISTORY. Refer to the Operator's Manual for the detail of this procedure. The error code will be lost when the power is turned off.
- Always check all the cable connections in the defibrillator before performing the action recommended in the troubleshooting tables in this section. This is because a loose cable connection can cause the defibrillator to display the error code.

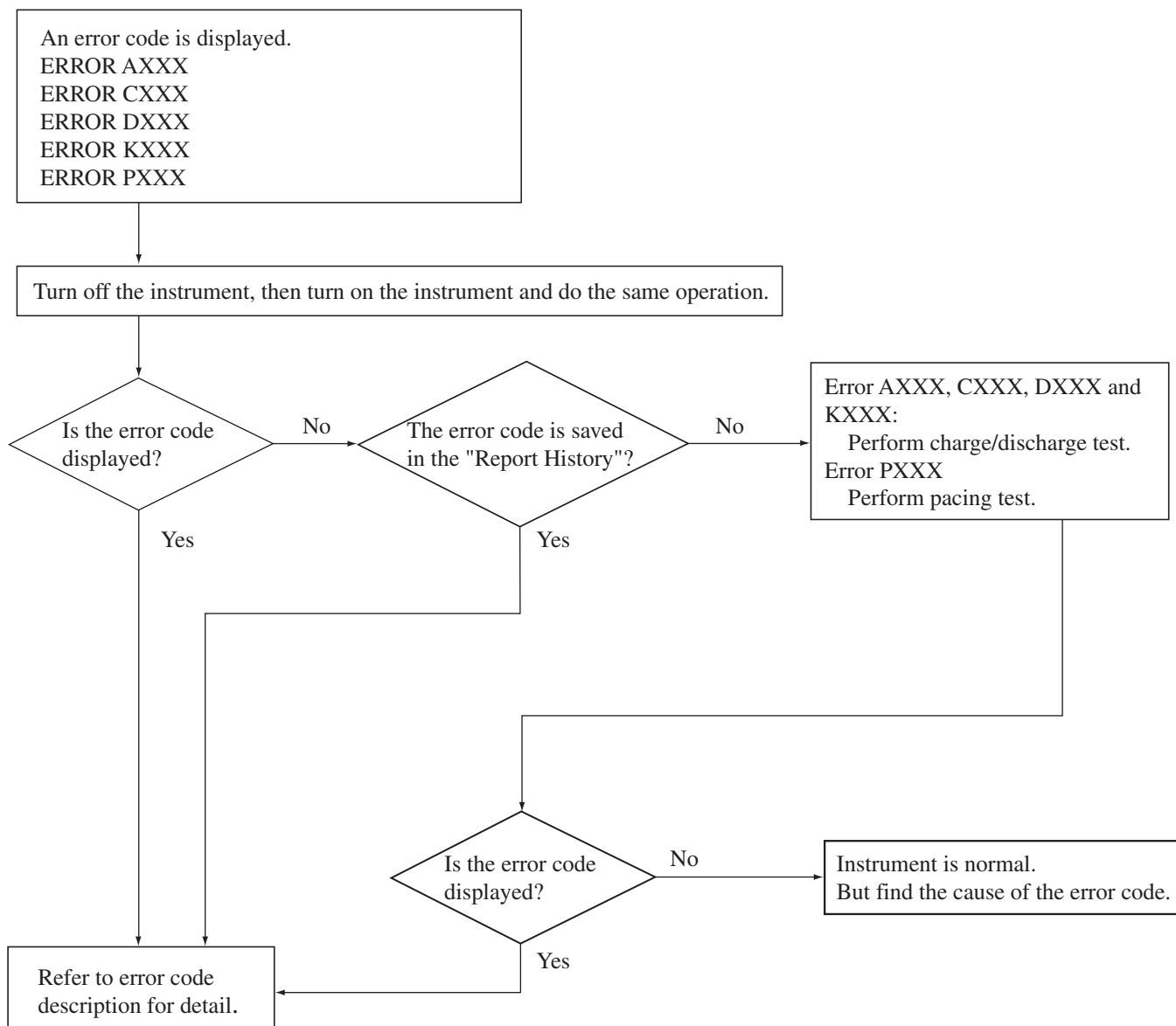



## Defibrillation

Error Code	Meaning	Possible Cause	Action
A501	During standby mode, the HV capacitor has more than 1 J energy more than one continuous second.	Faulty biphasic HV unit.	Discharge HV capacitor and replace the biphasic HV unit.
A512	When charging is started, the HV capacitor energy did not reach 1 J within 2 seconds.	Faulty biphasic HV unit.	Replace the biphasic HV unit.
		Faulty HV capacitor.	Replace the HV capacitor
A513	The energy is not reached to the selected energy within the specified time.	Faulty biphasic HV unit.	Replace the biphasic HV unit.
		Faulty HV capacitor.	Replace the HV capacitor
A524	After charging, the capacitor energy falls the specified value for each energy.	Faulty biphasic HV unit.	Replace the biphasic HV unit.
		Faulty HV capacitor.	Replace the HV capacitor
A527	After charging, the capacitor energy is about 15% above the selected energy.	Faulty biphasic HV unit.	Replace the biphasic HV unit.
A529	After charging, the actual charged energy is different from the selected energy.	Faulty biphasic HV unit.	Replace the biphasic HV unit.
A556	Internal discharge takes more than 20 seconds to complete.	Faulty biphasic HV unit.	Replace the biphasic HV unit.
		Faulty CPU board.	Replace the CPU board.
A566	HV capacitor's voltage did not reach its target value 20 seconds after adjusted internal discharge.	Faulty biphasic HV unit.	Replace the biphasic HV unit.
A585	The voltage of the HV capacitor exceeds its specified voltage.	Faulty biphasic HV unit.	Replace the biphasic HV unit.
		Faulty CPU board.	Replace the CPU board.
A587	When the disposable pad is used, 12.5% or more of the charged energy remains in the HV capacitor 2 seconds after external discharge.	Faulty biphasic HV unit.	Replace the biphasic HV unit.
		Faulty CPU board.	Replace the CPU board.
A597	When discharging, the second phase pulse is not output.	Faulty biphasic HV unit.	Replace the biphasic HV unit.
		Faulty CPU board.	Replace the CPU board.

## Operation Panel

### NOTE

- When the power is on, the following key switch is pressed and held for more than 10 seconds, the error code of each key is displayed.
- If the key was not pressed and held, check each key function with the System Maintenance screen. Refer to Section 4 “System Maintenance Screen - Check Hardware Screen - Check Key Screen”.

Error Code	Meaning	Possible Cause	Action
K501	The ECG lead key error is detected.	Faulty key board.	Replace the key board.
		Faulty CPU board.	Replace the CPU board.
K502	The ECG sensitivity key error is detected.	Faulty key board.	Replace the key board.
		Faulty CPU board.	Replace the CPU board.
K503	The silence alarm key error is detected.	Faulty key board.	Replace the key board.
		Faulty CPU board.	Replace the CPU board.
K504	The multi-function key error is detected.	Faulty key board.	Replace the key board.
		Faulty CPU board.	Replace the CPU board.
K505	The record key error is detected.	Faulty key board.	Replace the key board.
		Faulty CPU board.	Replace the CPU board.
K506	The event key error is detected.	Faulty key board.	Replace the key board.
		Faulty CPU board.	Replace the CPU board.
K507	The SYNC button error (front panel) is detected.	Faulty key board.	Replace the key board.
		Faulty CPU board.	Replace the CPU board.
K508	The CHARGE button error (front panel) is detected.	Faulty key board.	Replace the key board.
		Faulty CPU board.	Replace the CPU board.
K509	The DISCHARGE button error (front panel) is detected.	Faulty key board.	Replace the key board.
		Faulty CPU board.	Replace the CPU board.
K511	The CHARGE button error (apex external paddle) is detected.	Faulty external paddles.	Replace the external paddles.
		Faulty CPU board.	Replace the CPU board.
K512	The DISCHARGE button error (apex external paddle) is detected.	Faulty external paddles.	Replace the external paddles.
		Faulty CPU board.	Replace the CPU board.
K513	The DISCHARGE button error (sternum external paddle) is detected.	Faulty external paddles.	Replace the external paddles.
		Faulty CPU board.	Replace the CPU board.
K516	The PACING START/STOP key error is detected.	Faulty pacer board.	Replace the pacer board.
		Faulty CPU board.	Replace the CPU board.
K517	PACING RATE Up key error	Faulty pacer board.	Replace the pacer board.
		Faulty CPU board.	Replace the CPU board.
K518	PACING RATE Down key error	Faulty pacer board.	Replace the pacer board.
		Faulty CPU board.	Replace the CPU board.
K519	PACING CURRENT Up key error	Faulty pacer board.	Replace the pacer board.
		Faulty CPU board.	Replace the CPU board.
K520	PACING CURRENT Down key error	Faulty pacer board.	Replace the pacer board.
		Faulty CPU board.	Replace the CPU board.

## Communication

Error Code	Meaning	Possible Cause	Action
C501	When the CO2 sensor kit is connected, CO2 data is not received.	Faulty CO2 sensor kit.	Replace the CO2 sensor kit.
		Faulty DSI Float board.	Replace the DSI Float board.
		Faulty AUX OUT board.	Replace the AUX OUT board.
		Faulty CPU board.	Replace the CPU board.
C502	When the SpO2 adapter is connected, SpO2 data is not received.	Faulty SpO2 adapter.	Replace the SpO2 adapter.
		Faulty DSI Float board.	Replace the DSI Float board.
		Faulty AUX OUT board.	Replace the AUX OUT board.
		Faulty CPU board.	Replace the CPU board.
C505	The battery CPU does not transfer the battery data to the main CPU for more than 10 seconds.	Faulty mother board.	Replace the mother board.
		Faulty CPU board.	Replace the CPU board.
C507	When the power is turned on, the communication error between the RTC (real time clock) and main CPU is detected for one second.	Faulty CPU board.	Replace the CPU board.
C511	The sub CPU does not update the data in the DPRAM for one second.	Faulty CPU board.	Replace the CPU board.
C512	The voice CPU does not update the data in the DPRAM for one second.	Faulty CPU board.	Replace the CPU board.
C513	The DSI CPU does not update the data in the DPRAM for one second.	Faulty DSI Float board.	Replace the DSI Float board.
		Faulty AUX OUT board.	Replace the AUX OUT board.
		Faulty CPU board.	Replace the CPU board.
C514	The pacing CPU does not update the data in the DPRAM for one second.	Faulty pacer board.	Replace the pacer board
		Faulty CPU board.	Replace the CPU board.
C515	The HV CPU does not update the data in the DPRAM for one second.	Faulty biphasic HV unit.	Replace the biphasic HV unit.
		Faulty CPU board.	Replace the CPU board.

**Data Error**

<b>Error Code</b>	<b>Meaning</b>	<b>Possible Cause</b>	<b>Action</b>
D501	Data in the DRAM or flash memory is not read out correctly (summation error).	Faulty DRAM or flash memory.	Replace the CPU board.
D511	When the power is turned on, settings in the System Maintenance screen do not match the backup data in the flash memory.	After settings in the System Maintenance screen are changed, the “Flash Save” procedure is not performed.	Perform the “Flash Save” procedure in the System Maintenance screen.
		During power off sequence, power down occurs.	Delete the report data in the System Setup screen.
		Faulty CPU board.	Replace the CPU board.
D512	When the power is turned on, damaged waveform report data in the flash memory is detected.	During power off sequence, power down occurs.	Delete the report data in the System Setup screen.
		Faulty CPU board.	Replace the CPU board.

**Pacing (TEC-5531 Series Only)**

<b>Error Code</b>	<b>Meaning</b>	<b>Possible Cause</b>	<b>Action</b>
P502	Pulse width of the pacing output pulse is larger or smaller than the selected width.	Faulty pacer board.	Replace the pacer board.
		Faulty CPU board.	Replace the CPU board.
P503	Current intensity of the pacing output pulse is larger than the selected value.	Faulty pacer board.	Replace the pacer board.
		Faulty CPU board.	Replace the CPU board.
P504	Current intensity of the pacing output pulse is smaller than the selected value.	Faulty pacer board.	Replace the pacer board.
		Faulty CPU board.	Replace the CPU board.
P505	Pacing output that is not requested by the CPU is detected.	Faulty pacer board.	Replace the pacer board.
		Faulty CPU board.	Replace the CPU board.
P506	Pacing output voltage exceeds the upper limit.	Faulty pacer board.	Replace the pacer board.
		Faulty CPU board.	Replace the CPU board.
P511	Error was detected in the short-mode of the transistor.	Faulty pacer board.	Replace the pacer board.

## Message

Message	Meaning	Possible Cause	Action
Battery charge timed out	During battery test, the battery was not fully charged 5 hours after battery charging started.	Faulty battery pack.	Replace the battery pack.
		Faulty mother board.	Replace the mother board.
Battery charging error	During battery test An error occurred in battery charging	Faulty battery pack.	Replace the battery pack.
		Faulty mother board.	Replace the mother board.
Battery discharge timed out	During battery test The voltage did not decrease to the specified level 4 hours after battery discharging started.	Faulty battery pack.	Replace the battery pack.
		Faulty mother board.	Replace the mother board.
		Faulty CPU board.	Replace the CPU board.
Capacitor test fail	Capacitor test failed.	Faulty biphasic HV unit.	Replace the biphasic HV unit.
		Faulty HV capacitor.	Replace the HV capacitor.
CO2 module not working	CO2 module is faulty.	Faulty CO2 sensor kit.	Replace the CO2 sensor kit.
		Faulty the DSI Float board or AUX OUT board.	Replace the DSI Float board or AUX OUT board.
CO2 module disconnected	CO2 cable is disconnected from the defibrillator.	CO2 cable is disconnected from the DSI Interface Unit or DSI/AUX OUT Interface Unit.	Press the Silence alarm key to turn off the message. If the message still appears, the DSI Float board or AUX OUT board is faulty. Replace the DSI Float board or AUX OUT board.
		Faulty DSI Float board or AUX OUT board.	
ERROR AXXX	Faulty HV	---	Turn off the defibrillator, then turn on and do the same operation. If the message still appears, refer to the table for each error code.
ERROR CXXX	Communication error		
ERROR DXXX	Faulty ROM/RAM		
ERROR KXXX	Faulty keys		
ERROR PXXX	Faulty pacing unit		
FET error	The circuit to measure remaining battery charge is faulty.	Faulty mother board.	Replace the mother board.
High voltage monitor error	Faulty high voltage monitor circuit.	Faulty biphasic HV unit or CPU board.	Turn off the defibrillator, then turn on and do the same operation. If the message still appears, the biphasic HV unit or CPU board is faulty. Replace the biphasic HV unit or CPU board.

## 2. TROUBLESHOOTING

Message	Meaning	Possible Cause	Action
Overheating	The high voltage charge circuit heats up.	The defibrillator discharged too frequently.	Turn off the defibrillator and leave the defibrillator for 10 minutes, then turn on.
Power abnormality	Input power voltage is too high.	Not specified battery is used.	Only use the NKB-301V battery.
Relay drive error	Faulty biphasic HV unit.	Faulty biphasic HV unit.	Replace the biphasic HV unit.
		Faulty CPU board.	Replace the CPU board.
Replace battery	Battery test result is 0 to 49%. The defibrillator judged that the battery should be replaced with a new one.	Faulty battery pack.	Replace the battery.
SpO2 module not working	SpO2 module is faulty.	Faulty the SpO2 adapter.	Replace the SpO2 adapter.
		Faulty the DSI Float board or AUX OUT board.	Replace the DSI Float board or AUX OUT board.
SpO2 module disconnected	SpO2 cable is disconnected from the defibrillator.	SpO2 cable is disconnected from the DSI interface unit or DSI/AUX OUT interface unit.	Press the Silence alarm key to turn off the message. If the message still appears, the DSI Float board or AUX OUT board is faulty. Replace the DSI Float board or AUX OUT board.
		Faulty DSI Float board or AUX OUT board.	

## Troubleshooting

### General

Problem	Possible Cause	Action
The defibrillator heats up.	The defibrillator is used for many hours.	There is no abnormality in the defibrillator. Turn off the defibrillator and disconnect the power cord.
No operation when the defibrillator is turned on.	The power cord is disconnected.	Firmly connect the power cord to the AC outlet and the defibrillator.
	The battery is not installed.	Install the specified battery.
	Faulty battery	Replace the battery with a new one (NKB-301V).
	Remaining battery charge is low.	Charge the battery.
	Faulty key board.	Replace the key board.
	Faulty mother board.	Replace the mother board.
	Faulty AC/DC unit.	Replace the AC/DC unit.
Screen is dim. Waveform and characters are not seen.	Faulty LCD inverter board.	Replace the LCD inverter board.
	Faulty LCD unit.	Replace the LCD unit.
	Faulty mother board.	Replace the mother board.
	Faulty CPU board.	Replace the CPU board.
The printed data is JAN/01/80.	The backup battery is almost discharged.	Replace the CPU board. (Under normal use condition, the backup battery lifetime is about 6 years.)
The report data are not saved.	On the Setup screen, the report data were deleted.	Deleted data cannot be recovered.
	During power off sequence, power down occurs.	Do not disconnect the AC power cord or do not remove the battery while the "Shutdown" message is displayed.
	Faulty CPU board.	Replace the CPU board.
All settings set in the Setup screen and System Setup screen return to the default settings.	During power off sequence, power down occurs.	Do not disconnect the AC power cord or do not remove the battery while the "Shutdown" message is displayed.
	Faulty CPU board.	Replace the CPU board.

## 2. TROUBLESHOOTING

Problem	Possible Cause	Action
When the battery is installed, the defibrillator suddenly changes to battery operation.	Power voltage changed.	Check that the AC power cord is connected to the defibrillator. If the trouble is not solved, the AC/DC unit or AC power cord faulty. Replace the AC/DC unit or AC power cord.
When the battery is not installed, the defibrillator power suddenly drops.		
The date and time printed on the recording paper is incorrect.	---	Set the date and time on the Setup screen. Refer to Section 3 of the operator's manual
	The backup battery for the clock is discharged.	Replace the backup battery.
	Faulty CPU board.	Replace the CPU board.

### Defibrillation

Problem	Possible Cause	Action
The defibrillator self-discharges the energy during charging.	In battery operation, the battery is almost discharged.	Operate the defibrillator on AC power and recharge the battery. The battery is automatically charged when the defibrillator is connected to AC power.
	Faulty biphasic HV unit. (Error code appears on the screen.)	When an error code appears on the screen, refer to the Defibrillation table in the Error Code section.
Cannot switch to synchronized mode.	Appropriate lead is not selected.	Change to the appropriate lead.
	You tried to perform synchronized cardioversion with the PADDLE lead but synchronized cardioversion with the PADDLE lead is set to OFF on the Paddle Setup screen.	On the Paddle Setup screen, set the "sync by paddle lead" to ON.
	Faulty key board.	Replace the key board.
	Faulty CPU board.	Replace the CPU board.
"0 J" is printed on the defibrillation report recording.	TTR is 15 $\Omega$ or less	Check that the paddles do not touch each other.
	TTR is 255 $\Omega$ or more.	Press the paddles on the patient firmly.



## Monitoring

### ECG

Problem	Possible Cause	Action
Dotted lines appear instead of the ECG waveforms.	An ECG electrode is detached.	Remove the cause of the trouble. If the trouble is not solved, the mother board is fault. Replace the mother board.
	An electrode lead is disconnected from the electrode.	
	The ECG connection cable is disconnected from the defibrillator.	
	An electrode lead is faulty.	
	Faulty mother board.	
No sync sound	Faulty CPU board.	Replace the CPU board.
No alarm is generated	The SILENCE ALARMS key is pressed.	Press the SILENCE ALARMS key again.
	On the Setup screen, alarm is set to OFF.	On the Setup screen, set the upper/lower limit of each vital alarm.
	Faulty CPU board.	Replace the CPU board.
No sound	Faulty speaker or speaker cable.	Replace the speaker
	Faulty key board.	Replace the key board.
	Faulty CPU board.	Replace the CPU board.

### SpO<sub>2</sub>

Problem	Possible Cause	Action
SpO <sub>2</sub> value is not displayed on the screen.	The SpO <sub>2</sub> adapter cable is disconnected from the SpO <sub>2</sub> /CO <sub>2</sub> connector.	Connect the SpO <sub>2</sub> adapter to the SpO <sub>2</sub> /CO <sub>2</sub> connector.
	The SpO <sub>2</sub> probe is disconnected from the SpO <sub>2</sub> adapter.	Firmly connect the probe to the SpO <sub>2</sub> adapter.
	Cable discontinuity in SpO <sub>2</sub> adapter or probe	Replace the SpO <sub>2</sub> adapter or probe.
	SpO <sub>2</sub> probe attachment to the patient is loose.	Firmly attach the probe to the patient.
Dotted lines appear instead of the pulse waveforms.	Faulty SpO <sub>2</sub> probe.	Replace the SpO <sub>2</sub> probe.
	Faulty SpO <sub>2</sub> adapter.	Replace the SpO <sub>2</sub> adapter.
	Faulty DSI Float board.	Replace the DSI Float board.
	Faulty AUX OUT board.	Replace the AUX OUT board.
Deformed or damaged SpO <sub>2</sub> probe	Probe was disinfected in a way other than the specified way.	Replace the probe with a new one. Use the specified disinfecting method.
	SpO <sub>2</sub> probe is repeatedly used.	Replace the probe with a new one when its lifetime is over.

## 2. TROUBLESHOOTING

### CO<sub>2</sub>

Problem	Possible Cause	Action
The measured value is not displayed on the screen.	The CO <sub>2</sub> sensor kit cable is disconnected from the SpO <sub>2</sub> /CO <sub>2</sub> connector.	Connect the CO <sub>2</sub> sensor kit cable to the SpO <sub>2</sub> / CO <sub>2</sub> connector.
	CO <sub>2</sub> gas is in the inspiration.	With the CO <sub>2</sub> sensor kit, measurements are based on the assumption of no CO <sub>2</sub> gas in the inspiration. Do not connect a Jackson Rees respiration circuit or Mapleson D respiration circuit to the patient. Measurement cannot be done correctly.
	The airway adapter is dirty.	Replace the airway adapter with a new one.
	The measurement is performed where atmospheric pressure is low, such as at high altitude.	Consider the atmospheric pressure when making evaluations.
The red LED on the CO <sub>2</sub> adapter blinks.	CO <sub>2</sub> sensor or CO <sub>2</sub> adapter is faulty.	Replace the CO <sub>2</sub> sensor or CO <sub>2</sub> adapter with a new one.
	The respiration has not been detected for longer than 20 s.	The red LED blinks when the respiration has not been detected for longer than 20 s regardless of the alarm setting on the defibrillator.

## Recording

Problem	Possible Cause	Action
Printing is blurred. Dots are missing.	The specified recording paper is not used.	Use the specified recording paper.
	The thermal head is dirty.	Clean the thermal head with the head cleaning pen. If the trouble not solved, the recorder unit is faulty. Replace the recorder unit.
There is no printing.	The recording paper is not loaded.	Load new recording paper.
	Recording unit door is not properly closed.	Close the door until it clicks.
	The recording paper is set with the wrong side facing up.	Set the recording paper correctly.
	The thermal head heats up.	Stop recording and cool the defibrillator down in a cooler place.
	Faulty key board.	Check the key function and recorder with the System Maintenance screen. If the recorder check is passed, the key board is faulty. Replace the key board.
	Faulty recorder. Faulty CPU board.	Check the recorder in the System Maintenance screen.
Printing is thick.	The recording unit temperature is too hot.	Cool the defibrillator down in a cooler place. If the trouble is not solved, the recorder unit or CPU board is faulty. Replace the recorder unit or CPU board.
Paper feeding speed is unstable.	The specified paper is not used.	Use the specified recording paper.
	The recorder unit is not working.	Replace the recorder unit.
	Faulty mother board.	Replace the mother board.

## Battery

Problem	Possible Cause	Action
The battery charging lamp is blinking.	The defibrillator and battery are too hot.	Bring the defibrillator to a cool place. When the battery temperature decreases, charging resumes.
After starting battery charging, the charging stops. (neither battery charging lamp nor battery charge complete lamp lights.)	Faulty battery	Replace the battery with a new one.
	Charging circuit is not working.	Replace the mother board.

**Pacing (TEC-5531 Series Only)**

<b>Problem</b>	<b>Possible Cause</b>	<b>Action</b>
Although the PULSE lamp is lit, pacing pulse does not appear on the ECG.	Faulty pacer board.	Replace the pacer board.
	Faulty CPU board.	Replace the CPU board.
Although the START/STOP lamp is lit, pacing does not start.	Pacing current is set to 0 mA.	Set the appropriate pacing current with the PACING OUTPUT control.
	In DEMAND mode, selected pacing rate is slower than the patient heart rate.	Set the pacing rate appropriate for the patient heart rate. When the patient heart rate is slower than the selected pacing rate, pacing pulse is output automatically.
	Faulty pacer board.	Replace the pacer board.
	Faulty CPU board.	Replace the CPU board.

# *Section 3    Disassembly*

Before You Begin .....	3.1
Warnings, Cautions and Notes .....	3.1
Required Tools .....	3.2
Connection Diagram .....	3.3
Removing the Lower Casing .....	3.5
Removing the Paddles .....	3.5
Removing the Battery Pack .....	3.5
Removing the Lower Casing .....	3.6
Removing the CPU Board and Mother board .....	3.7
Removing the CPU Board .....	3.7
Removing the Mother Board .....	3.8
Removing the Front Chassis .....	3.9
Removing the Side Casing .....	3.10
Removing the Recorder Unit .....	3.11
Removing the Biphasic HV Unit .....	3.12
Removing the HV Capacitor .....	3.14
Attaching the HV Capacitor .....	3.15
Removing the AC/DC Unit .....	3.16
Removing the Test Load Board .....	3.17
Removing the Pacer Board (TEC-5531 Series Only) .....	3.18
Removing the LCD Unit .....	3.19
Removing the Key Board .....	3.20
Removing the Energy/Mode Select Control Knob .....	3.20
Removing the Speaker .....	3.21
Removing the Paddle Lock Springs .....	3.22
Removing the AC SOURCE Socket .....	3.23

**This page is intentionally left blank.**

The procedures in this section explain how to remove, replace and install major components in the defibrillator.

## Before You Begin

### Warnings, Cautions and Notes

---

---

#### WARNING

- The HV capacitor can store lethal amounts of energy. Discharge this capacitor before touching any high voltage component (HV capacitor, biphasic HV unit, paddle socket or paddles).
- Removal and replacement of any components in the defibrillator should only be done by qualified service personnel.
- To avoid the possibility of injury to yourself or damage to the defibrillator, do not install or remove any component while the power is on. When disassembling, make sure that the defibrillator is off, the AC power cord is disconnected from the defibrillator and the battery pack is removed from the defibrillator.

There are several high voltage units inside the defibrillator: LCD backlight, high voltage capacitor, pacing DC/DC converter and switching regulator.

---

---

#### CAUTIONS

- To avoid accidental discharge of static electricity which could damage the components of the defibrillator, use a grounded wrist strap when installing or removing any component of the defibrillator.
  - Fuses on the main board and AC/DC unit cut off the power when an abnormality occurs in the defibrillator. Eliminate the malfunction before replacing the fuse. Use the correct fuse only.
  - Use only parts recommended by Nihon Kohden to assure maximum performance from your defibrillator.
- 
-

### NOTE

When the mother board, CPU board, biphasic HV unit, HV capacitor is replaced with a new one, do the following adjustment. Refer to “System Maintenance Screen - Adjust AD Screen” in Section 4.

**Mother board:**

- ECG sensitivity and offset
- Battery voltage setting
- Paddle contact impedance threshold

**CPU board:**

- ECG sensitivity and offset
- Charge energy, charge time, delivered energy and TTR
- Battery voltage setting
- Paddle contact impedance threshold

**Biphasic HV unit:**

- Charge energy, charge time, delivered energy and TTR
- Paddle contact impedance threshold

**HV capacitor:**

- Charge energy, charge time, delivered energy and TTR

### Required Tools

- Anti-static bench mat
- Wrist ground strap
- Phillips screwdriver (insulated type, for M3 and M4 screws)
- Hex socket driver (for 3 mm spacer bolt and nut)
- Allen wrench
- Tweezers
- Short bar



# Connection Diagram

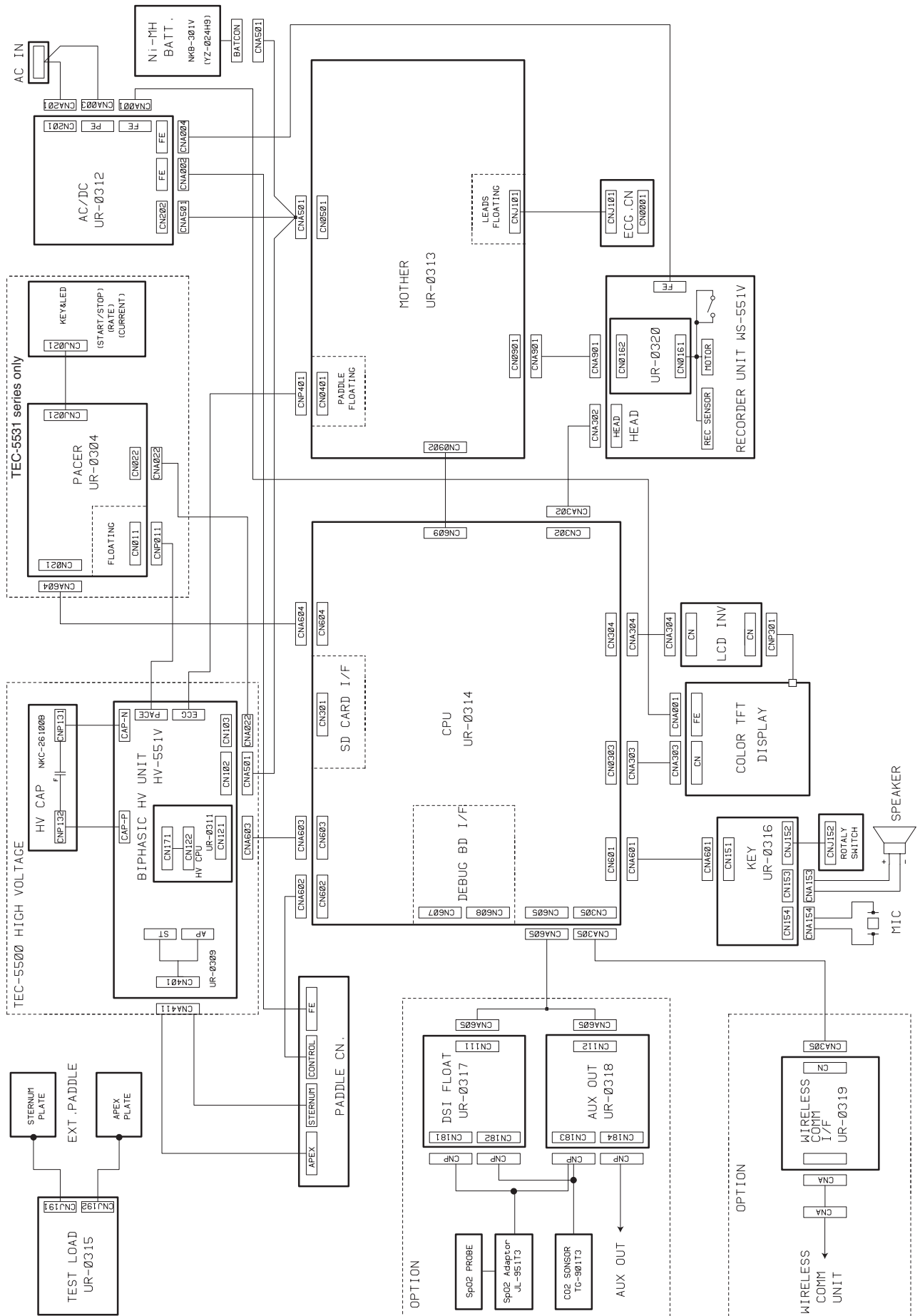

3. DISASSEMBLY

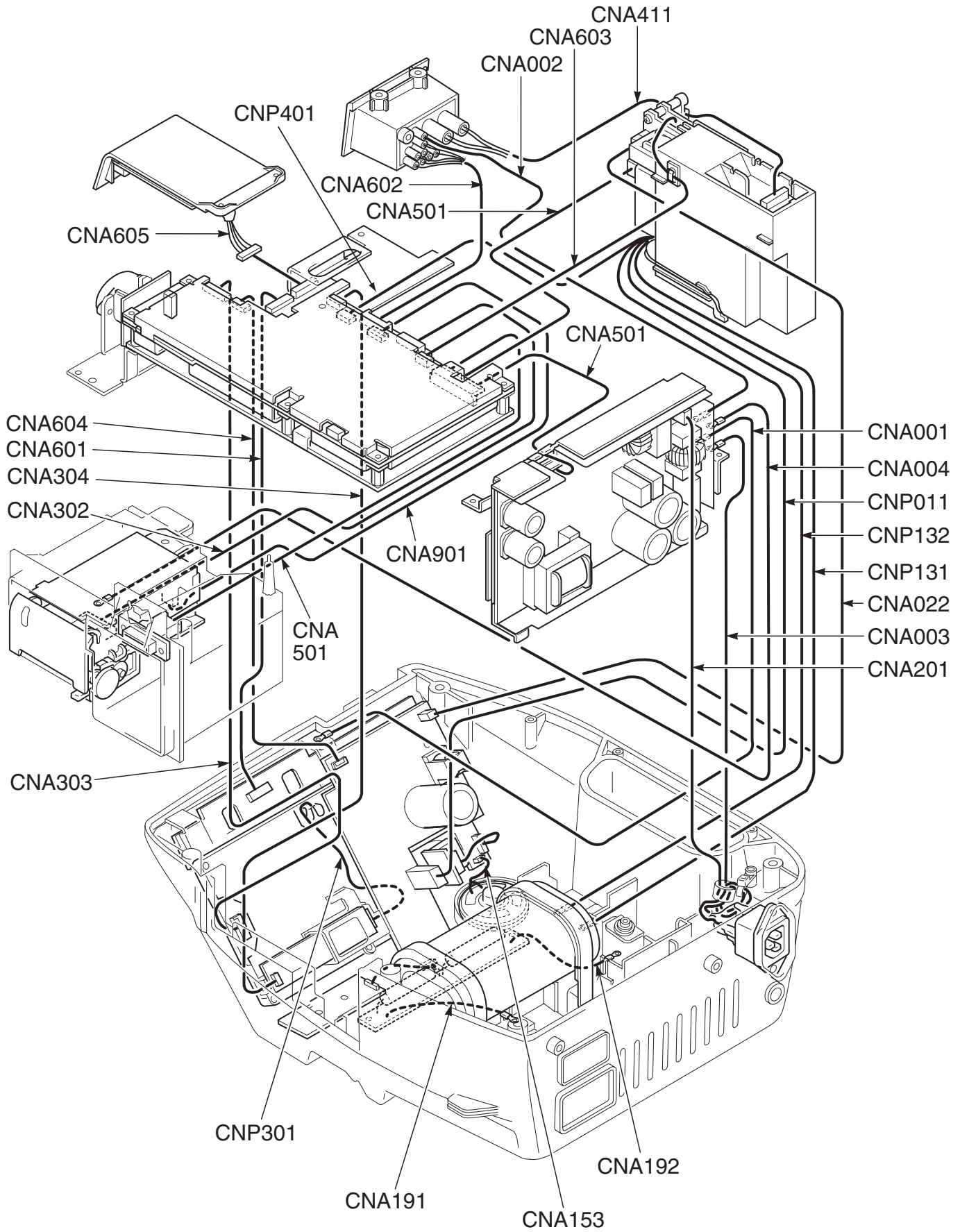

TEC-5531 with optional interface unit

## Removing the Lower Casing

### Removing the Paddles

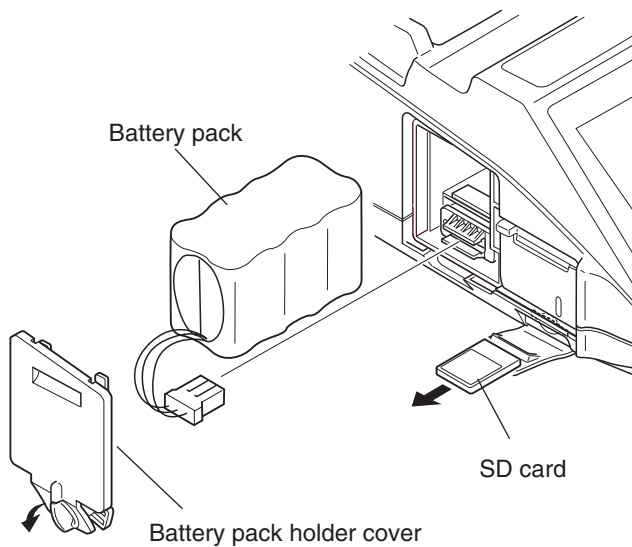
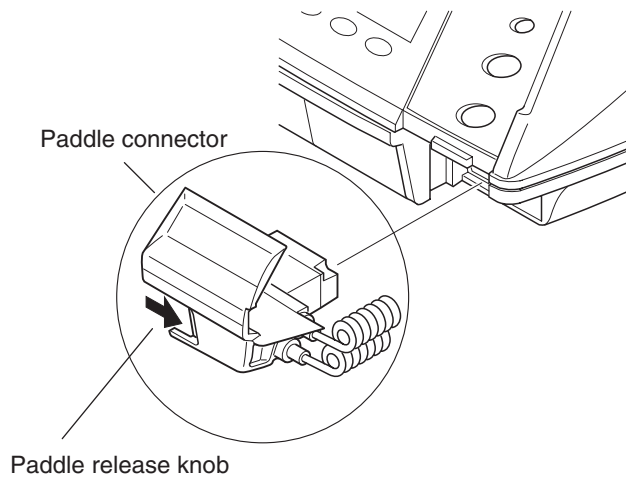

### Removing the Battery Pack

1. Make sure that the power of the defibrillator is turned off.
2. Disconnect the AC power cord from the AC outlet and defibrillator.
3. Remove the paddles. To remove the paddles, press and hold the paddle release knob on the paddle connector and pull the paddle connector toward you.

#### CAUTION

**When removing the paddle, do not pull anywhere other than the paddle connector. Otherwise, the paddle connector or paddle cable may be damaged.**

4. If the SD card is inserted, remove it. To remove the SD card, push it in, then pull it out.

1. Turn the knob on the battery holder cover counterclockwise and remove the battery pack holder cover.
2. Disconnect the battery cable by holding the battery cable connector and remove the battery from the defibrillator.

### 3. DISASSEMBLY

#### Removing the Lower Casing

1. Remove the seven M4×10 binding head screws (BH) and two M3×8 binding head screws.
2. Remove the lower casing from the upper casing.

If the optional DSI interface unit or DSI/AUXOUT interface unit is installed,

- 1) Remove the two M3×8 binding head screws.
- 2) Remove the interface unit and disconnect the CNA605 cable from the defibrillator.

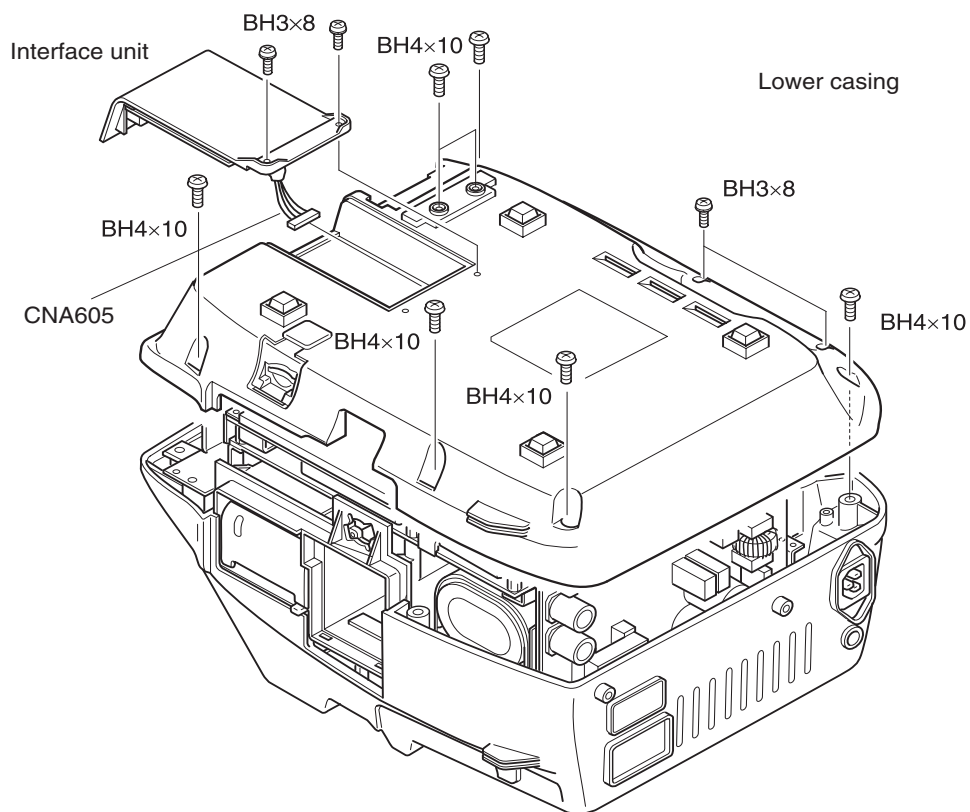

## Removing the CPU Board and Mother board

### Removing the CPU Board

1. Remove the paddles, battery pack, SD card and lower casing. Refer to “Removing the Lower Casing”.
2. Remove the six M3×8 pan screws with washers (PS) which secure the main shield plate 1 to the CPU board.
3. Disconnect the following cables:
  - CNA302 cable: Connects to the recorder unit (thermal head)
  - CNA304 cable: Connects to the LCD INV (inverter) board
  - CNA303 film cable: Connects to the LCD unit
  - CNA601 film cable: Connects to the KEY board
  - CNA602 cable: Connects to the paddle socket
  - CNA603 cable: Connects to the biphasic HV unit
  - CNA604 film cable: Connects to the Pacer board (TEC-5531 series only)

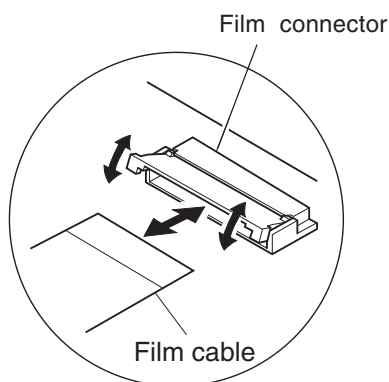

To remove the film cable from the film cable connector, gently release the lock of the film cable connector with a small flat blade driver and your finger as shown in the expanded illustration. Be careful because the film cable connector is easily damaged.

4. Remove the CPU board.

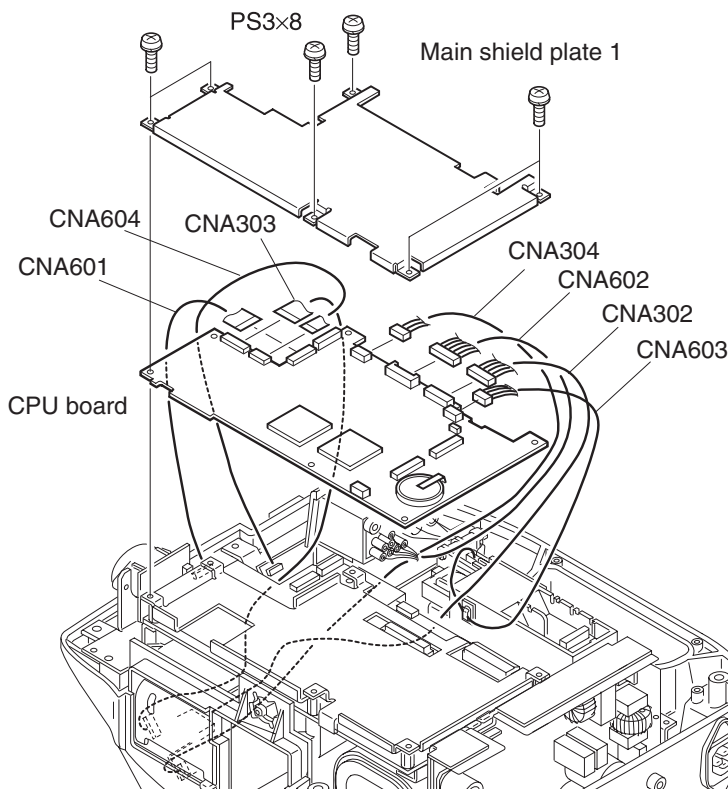

### NOTE

When the CPU board is replaced with a new one, do the following adjustment. Refer to “System Maintenance Screen - Adjust AD Screen” in Section 4.

- ECG sensitivity and offset
- Charge energy, charge time, delivered energy and TTR
- Battery voltage setting
- Paddle contact impedance threshold

## Removing the Mother Board

When the CPU board is removed, you can remove the mother board.

1. Remove the main shield plate 2 and shield sheet.
2. Remove the six M3×8 spacer bolts which secure the mother board to the upper casing.
3. Remove the two M3×8 binding head screws (BH) which secure the ECG connector board to the front chassis
4. Disconnect the following cables:
  - CNA501 cable: Connects to the battery pack, AC/DC unit and biphasic HV unit
  - CNP401 cable: Connects to the biphasic HV unit
  - CNA901 cable: Connects to the recorder unit (REC-EXT board)
5. Remove the mother board from the upper casing.

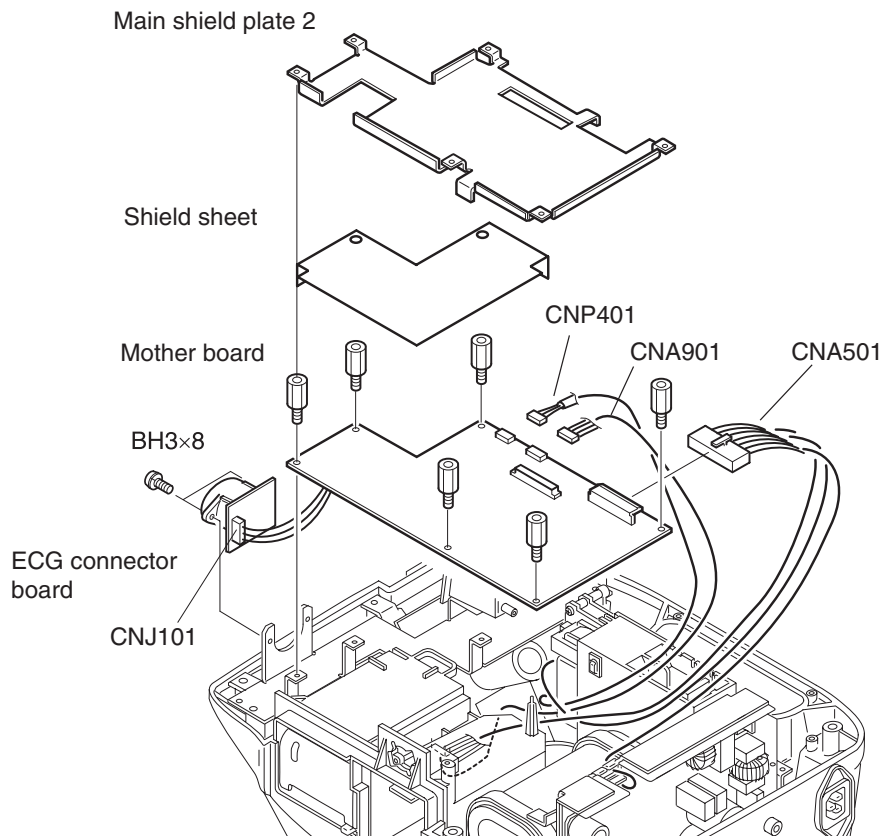

### NOTE

When the mother board is replaced with a new one, do the following adjustment. Refer to “System Maintenance Screen - Adjust AD Screen” in Section 4.

#### Mother board:

- ECG sensitivity and offset
- Battery voltage setting
- Paddle contact impedance threshold

## Removing the Front Chassis

### WARNING

The HV capacitor can store lethal amounts of energy. Discharge this capacitor before touching any high voltage component (HV capacitor, biphasic HV unit, paddle socket or paddles).

1. Remove the paddles, battery pack, SD card and lower casing. Refer to “Removing the Lower Casing”.
2. Remove the CPU board and mother board. Refer to “Removing the CPU Board and Mother Board”.
3. Remove the M3×8 pan screw with spring washer and washer (PSW), and M3×6 pan screw with washer (PS) which secure the front chassis to the upper casing.
4. Remove the cables from the cable tie.
5. Remove the front chassis from the upper casing.

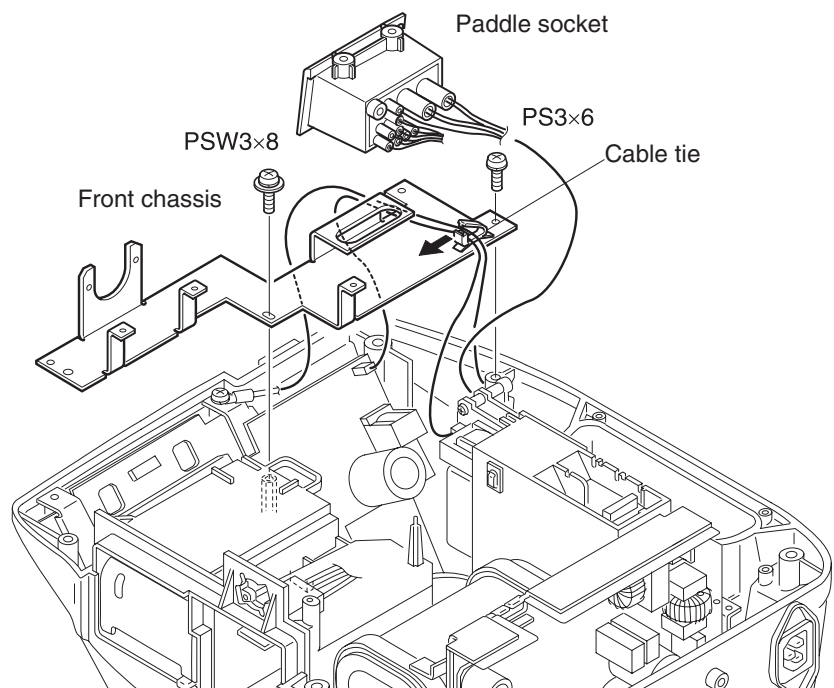

## Removing the Side Casing

1. Remove the paddles, battery pack, SD card and lower casing. Refer to “Removing the Lower Casing”.
2. Remove the CPU board and mother board. Refer to “Removing the CPU Board and Mother Board”.
3. Remove the M3×8 pan screw with spring washer and washer (PSW) which secures the cable tie to the spacer bolt.
4. Remove the M3×8 binding head screw (BH) which secures the side casing to the upper casing.
5. Remove the M3×6 pan screw with washer (PS) which secures the terminal of the CNA001 ground wire to the AC/DC unit.
6. Remove the M3×40 spacer bolt.
7. Remove the two M3×10 binding head screws which secure the battery connector cover to the connector of the CNA501 cable.
8. Pull out the side casing. Note that the CNA303 film cable which connects the LCD unit and CPU board runs through between the two hubs.

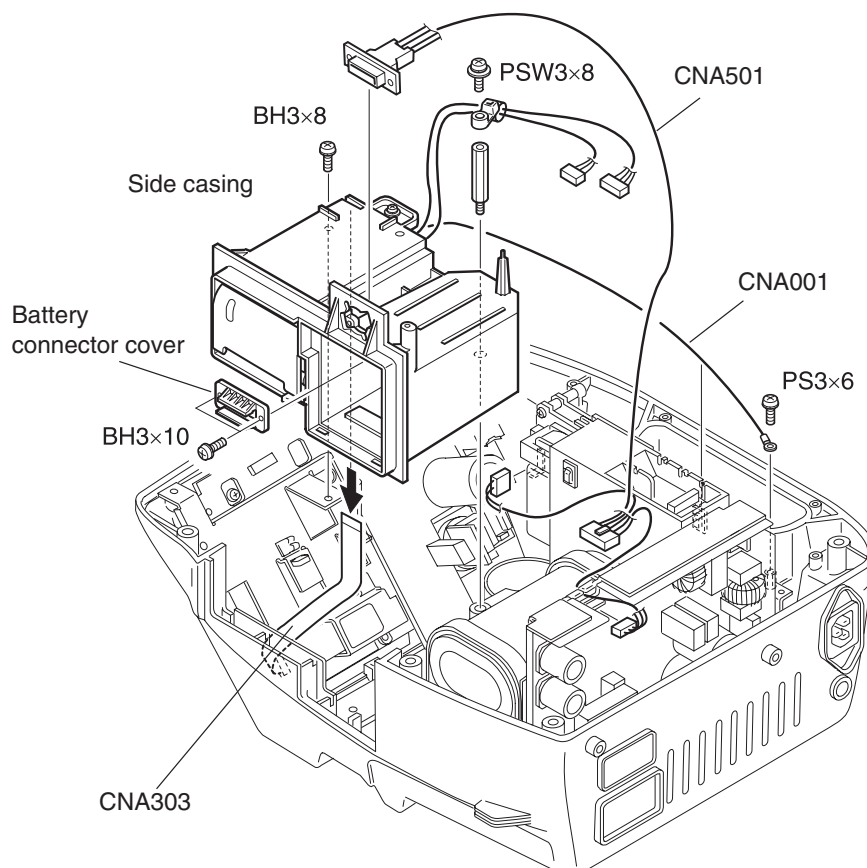



## Removing the Recorder Unit

1. Remove the M3×8 pan screw with spring washer and washer (PSW) which secures the recorder unit to the side casing.
2. Remove the recorder unit from the side casing.

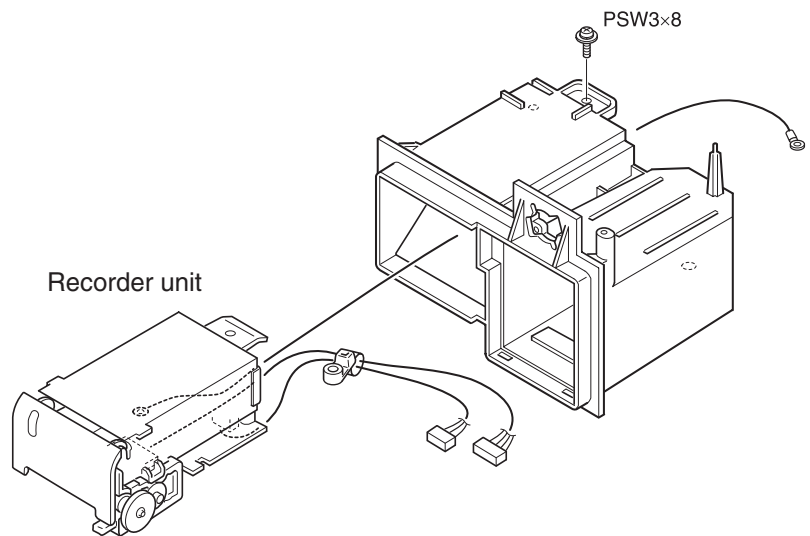

## Removing the Biphasic HV Unit

### WARNING

The HV capacitor can store lethal amounts of energy. Discharge this capacitor before touching any high voltage component (HV capacitor, biphasic HV unit, paddle socket or paddles).

1. Remove the paddles, battery pack, SD card and lower casing. Refer to “Removing the Lower Casing”.
2. Remove the CPU board and mother board. Refer to “Removing the CPU Board and Mother Board”.
3. Remove the front chassis. Refer to “Removing the Front Chassis”.
4. Remove the paddle socket.
  - 1) Remove the M3×8 pan screw with spring washer and washer (PSW) which secures the cable tie to the biphasic HV unit.
  - 2) Remove the M3×6 pan screw with washer (PS) which secures the terminal of the CNA002 ground wire to the AC/DC unit.
  - 3) Disconnect the CNA411 cable from the biphasic HV unit.

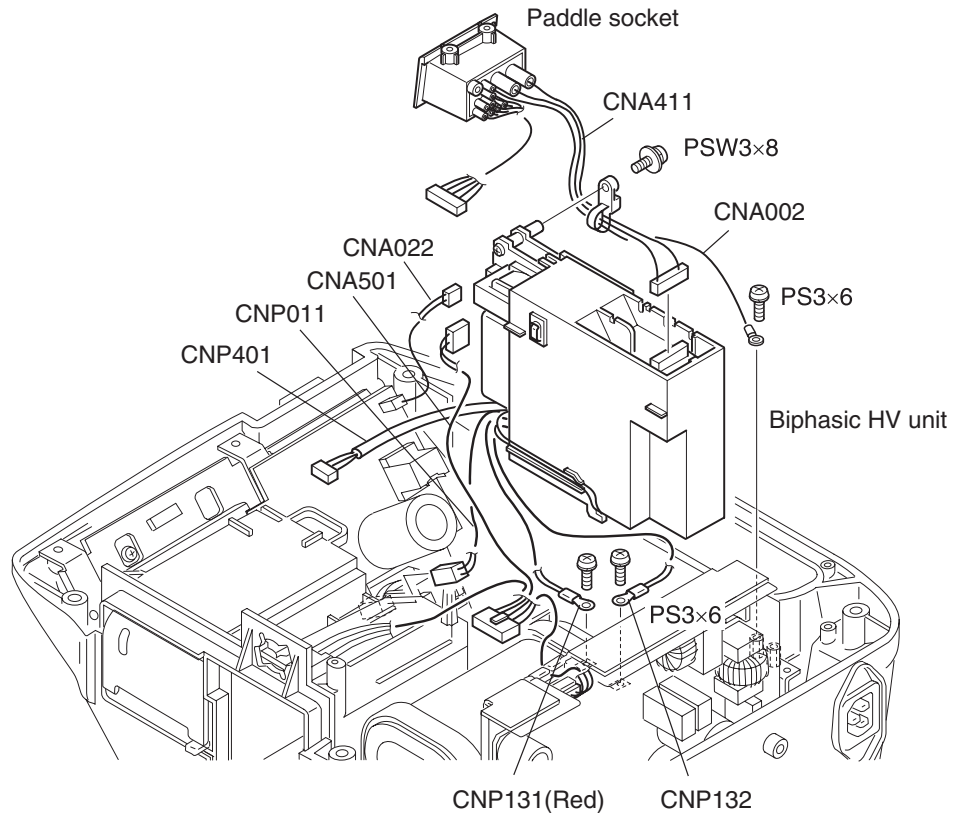

5. Disconnect the following cables:
  - CNA501 cables: Connects to the battery pack, mother board and AC/DC unit
  - CNP011 cable: Connects to the Pacer board (TEC-5531 series only)
  - CNA022 cable: Connects to the Pacer board (TEC-5531 series only)
6. Remove the two M3×6 pan screws with washers (PS) which secure the terminals of CNP131 and CNP132 wires to the HV capacitor.
7. Pull out the biphasic HV unit.

**NOTE**

**After replacing the biphasic HV unit, always check the following:**

- **Charge energy, charge time, delivered energy and TTR**
- **Paddle contact impedance threshold**

## Removing the HV Capacitor

### WARNING

The HV capacitor can store lethal amounts of energy. Discharge this capacitor before touching any high voltage component (HV capacitor, biphasic HV unit, paddle socket or paddles).

1. Remove the paddles, battery pack, SD card and lower casing. Refer to “Removing the Lower Casing”.
2. Remove the CPU board and mother board. Refer to “Removing the CPU Board and Mother Board”.
3. Remove the side casing. Refer to “Removing the Side Casing”.
4. Remove the four M3×6 pan screws with washers (PS) which secure the capacitor holders to the upper casing.
5. Remove the two M3×6 pan screws with washers which secure the terminals of CNP131 and CNP132 wires to the HV capacitor.
6. Pull out the HV capacitor.

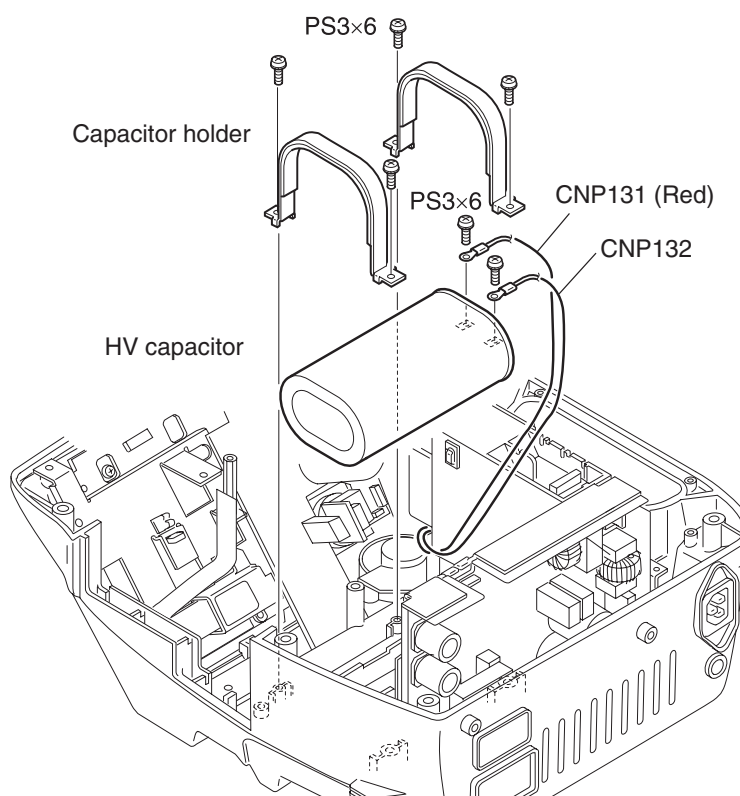

### **Attaching the HV Capacitor**

When attaching the HV capacitor, place the HV capacitor label side up and connect the red cable from the biphasic HV unit to the red labeled connector on the HV capacitor.

#### **NOTE**

**After replacing the HV capacitor, always check the following:**

- **Charge energy, charge time, delivered energy and TTR**

## Removing the AC/DC Unit

1. Remove the paddles, battery pack, SD card and lower casing. Refer to “Removing the Lower Casing”.
2. Remove the two M3×6 screws with washers (PS) and two M3×8 spacer bolts and remove the four ground wires (CNA001, CNA002, CNA003 and CNA004).
3. Disconnect the following cables:
  - CNA201 cable: Connects to the AC SOURCE socket
  - CNA501 cables: Connects to the battery pack, mother board and biphasic HV unit
4. Pull out the AC/DC unit.

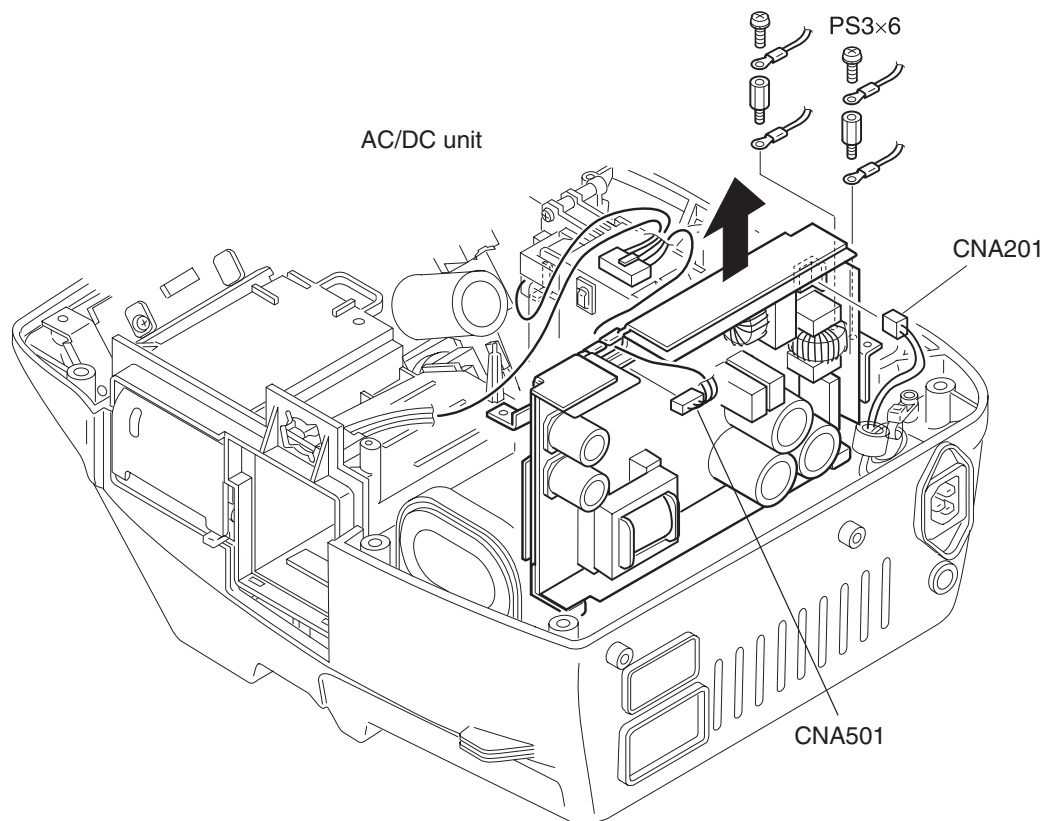

## Removing the Test Load Board

1. Remove the paddles, battery pack, SD card and lower casing. Refer to “Removing the Lower Casing”.
2. Remove the CPU board and mother board. Refer to “Removing the CPU Board and Mother Board”.
3. Remove the side casing. Refer to “Removing the Side Casing”.
4. Remove the HV capacitor. Refer to “Removing the HV Capacitor”.
5. Remove the test load cap.
6. Remove the two M3×6 screws with washers (PS) which secure the terminals of the test load board wires to the upper casing.
7. Remove the two M3×6 screws with washers which secure the test load board to the upper casing.
8. Remove the test load board.

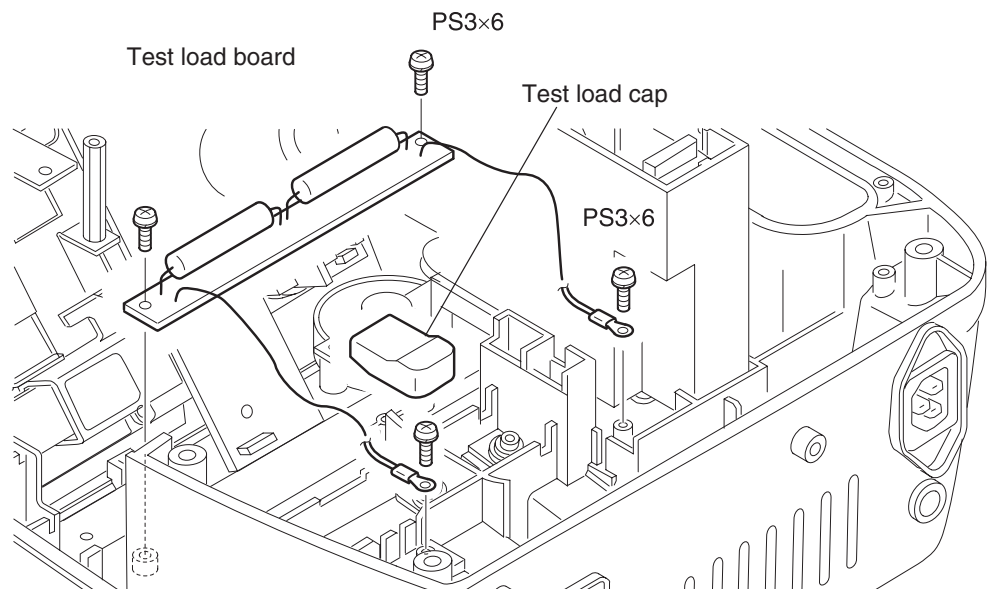

## Removing the Pacer Board (TEC-5531 Series Only)

1. Remove the paddles, battery pack, SD card and lower casing. Refer to “Removing the Lower Casing”.
2. Remove the CPU board and mother board. Refer to “Removing the CPU Board and Mother Board”.
3. Remove the front chassis. Refer to “Removing the Front Chassis”.
4. Remove the side casing. Refer to “Removing the Side Casing”.
5. Disconnect the following cables from the Pacer board:
  - CNP011 cable: Connects to the biphasic HV unit.
  - CNA022 cable: Connects to the biphasic HV unit.
6. Remove the four M3×6 screws with washers (PS) which secure the Pacer board to the upper casing.
7. Remove the two M3×6 screws with washers which secure the key & LED board to the upper casing.
8. Remove the Pacer board and Key & LED board.

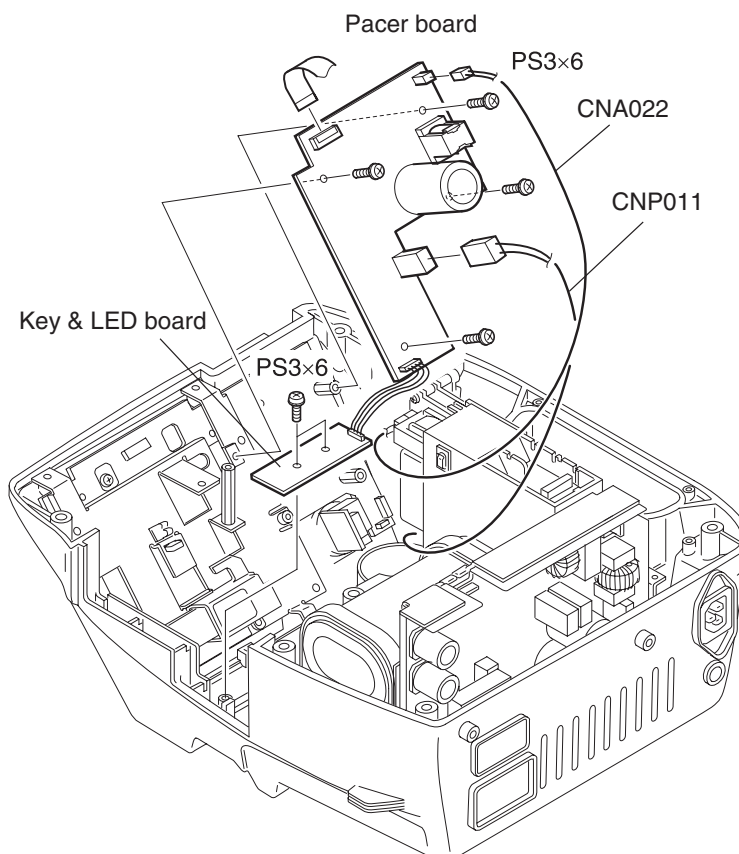



## Removing the LCD Unit

1. Remove the paddles, battery pack, SD card and lower casing. Refer to “Removing the Lower Casing”.
2. Remove the CPU board and mother board. Refer to “Removing the CPU Board and Mother Board”.
3. Remove the front chassis. Refer to “Removing the Front Chassis”.
4. Remove the side casing. Refer to “Removing the Side Casing”.
5. Remove the two M3×6 screws with washers (PS) which secure the LCD unit to the upper casing.
6. Remove the LCD unit.
7. Disconnect the CNP301 cable from the LCD INV board and remove the CNP301 cable from the cable tie.
8. Remove the four M3 tapping screws which secure the LCD display to the LCD chassis.
9. Remove the LCD display from the LCD chassis.

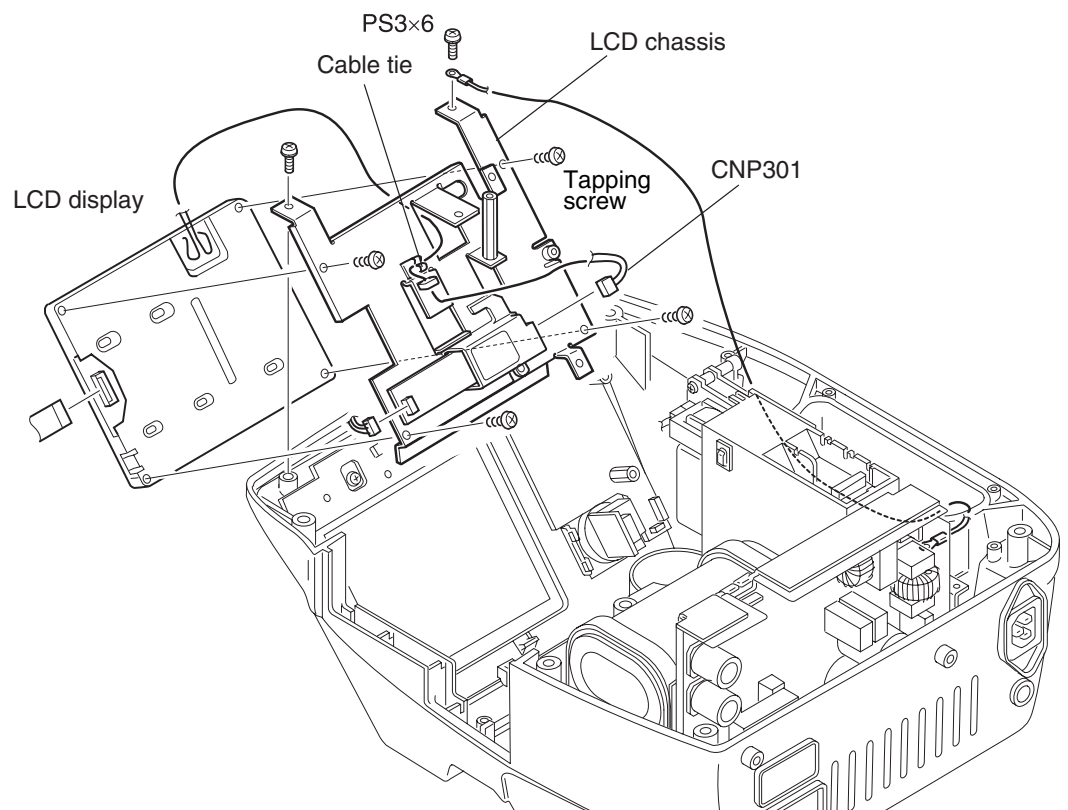

## Removing the Key Board

1. Remove the paddles, battery pack, SD card and lower casing. Refer to “Removing the Lower Casing”.
2. Remove the CPU board and mother board. Refer to “Removing the CPU Board and Mother Board”.
3. Remove the front chassis. Refer to “Removing the Front Chassis”.
4. Remove the side casing. Refer to “Removing the Side Casing”.
5. Remove the Pacer board if it is installed. Refer to “Removing the Pacer Board”.
6. Remove the LCD unit. Refer to “Removing the LCD Unit”.
7. Remove the followings which secure the Key board to the upper casing.  
TEC-5521 Series: Six M3×6 screws with washers (PS)  
TEC-5531 Series: Four M3×6 screws with washers and two M3×18 spacer bolts
8. Disconnect the CNA153 cable from the speaker.
9. Remove the Key board.

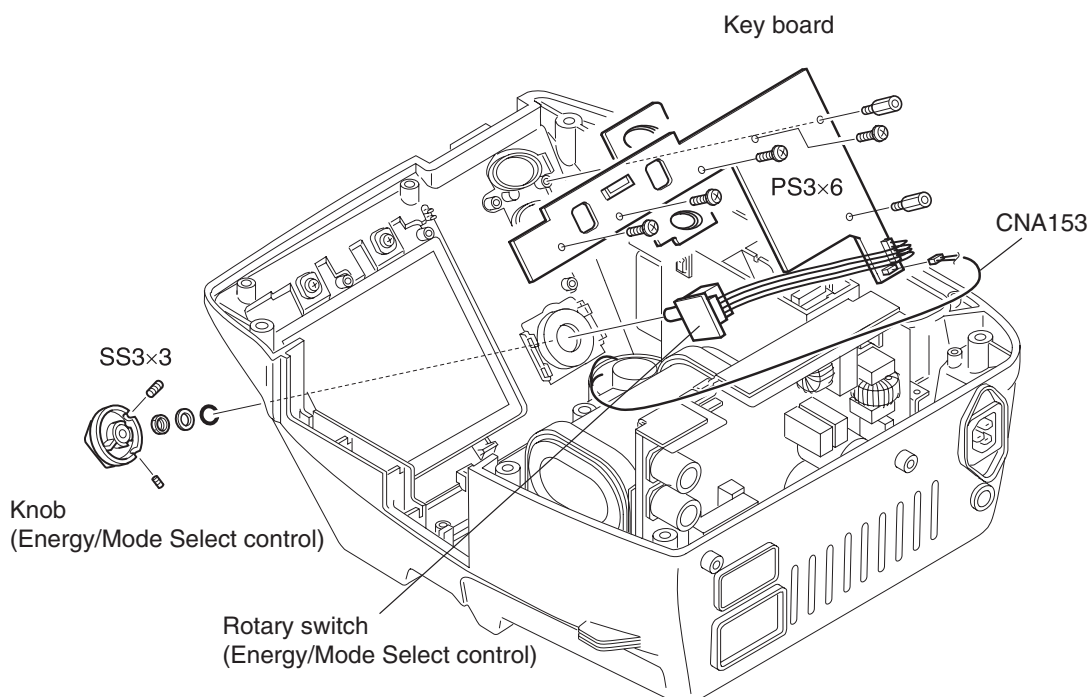

Example: TEC-5531 Series

### Removing the Energy/ Mode Select Control Knob

To remove the Energy/Mode Select control knob on the front panel.

1. Remove the two allen screws on the Energy/Mode Select control knob.
2. Remove the knob, nut, washer and SS3×3 O-ring from the rotary switch.

## Removing the Speaker

1. Remove the paddles, battery pack, SD card and lower casing. Refer to “Removing the Lower Casing”.
2. Remove the CPU board and mother board. Refer to “Removing the CPU Board and Mother Board”.
3. Remove the front chassis. Refer to “Removing the Front Chassis”.
4. Remove the side casing. Refer to “Removing the Side Casing”.
5. Remove the two M3×6 pan screws with washers (PS) which secure the speaker holder to the upper casing.
6. Disconnect the CNA153 cable from the Key board.

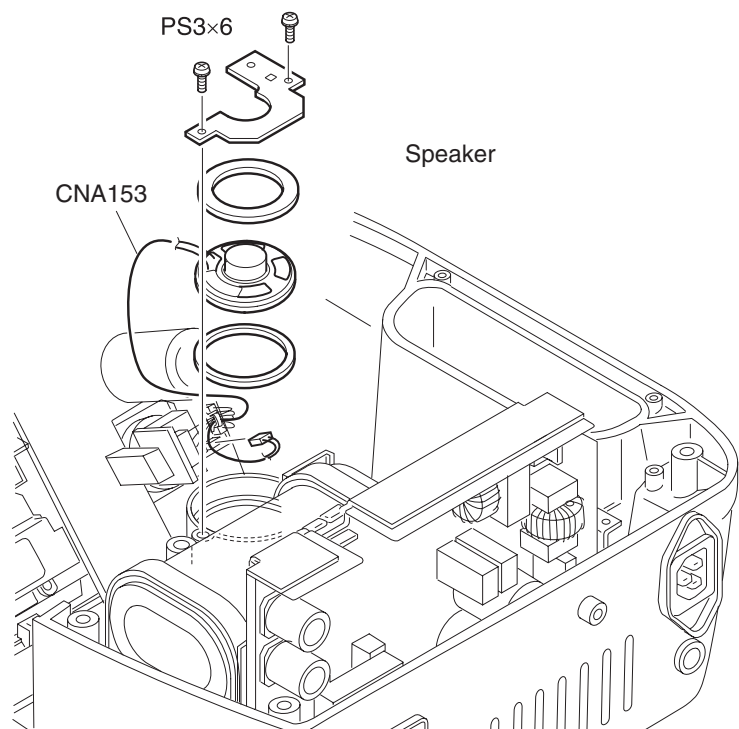

## Removing the Paddle Lock Springs

1. Remove the paddles, battery pack, SD card and lower casing. Refer to “Removing the Lower Casing”.
2. Remove the CPU board and mother board. Refer to “Removing the CPU Board and Mother Board”.
3. Remove the side casing. Refer to “Removing the Side Casing”.
4. Remove the biphasic HV unit. Refer to “Removing the Biphasic HV Unit”.
5. Remove the HV capacitor. Refer to “Removing the HV Capacitor”.
6. Remove the AC/DC unit. Refer to “Removing the AC/DC Unit”.
7. Remove the eight M3×8 binding head screws (BH) which secure the paddle locks to the upper casing.
8. Remove the paddle lock springs.

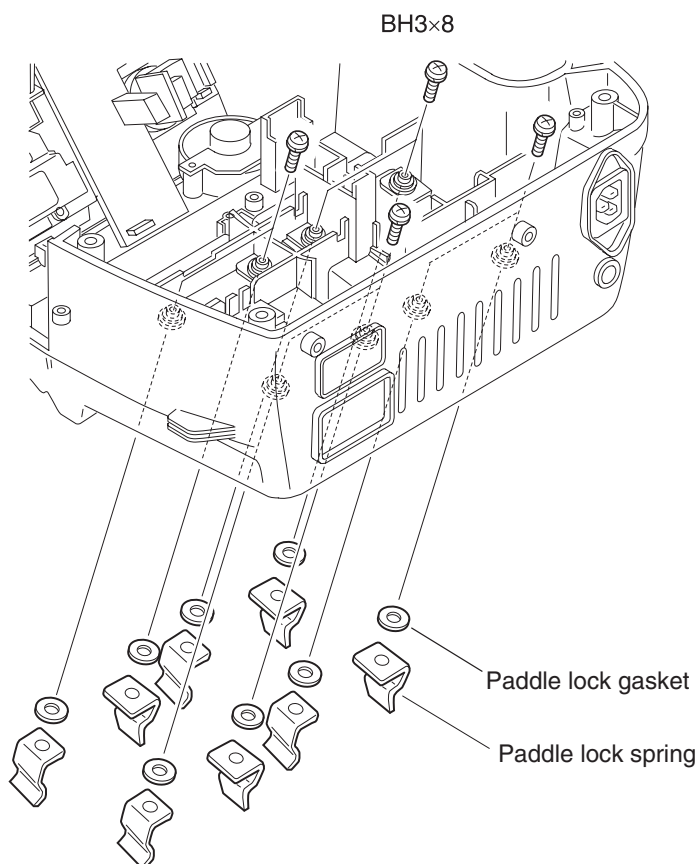

## Removing the AC SOURCE Socket

1. Remove the paddles, battery pack, SD card and lower casing. Refer to “Removing the Lower Casing”.
2. Remove the M3×6 screw with washer (PS) and M3×8 spacer bolt which secure the terminals of the ground wires to the upper casing.
3. Remove the M3×8 screw with spring washer and washer (PSW) which secures the cable tie to the upper casing.
4. Disconnect the CNA201 cable from the AC/DC unit.
5. Remove the two M3×8 binding head screw (BH) which secure the AC SOURCE socket to the upper casing.

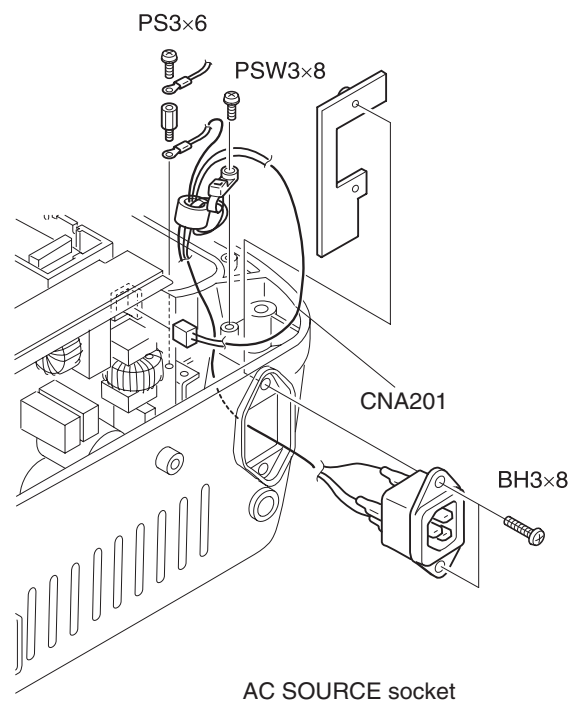

**This page is intentionally left blank.**

# Section 4 Maintenance

General .....	4.1
Daily Checks .....	4.1
Monthly Checks .....	4.1
System Maintenance Screen .....	4.3
Calling Up the System Maintenance Screen .....	4.3
About the Menu Items .....	4.4
System Maintenance Screen Flowchart .....	4.5
Default Settings .....	4.6
Flash Save Procedure .....	4.7
Configuration Screen .....	4.8
Adjust AD Screen .....	4.9
Adjust ECG A/D Screen .....	4.10
Adjust HV AD Screen .....	4.12
Adjust Battery AD Screen .....	4.15
Paddle Contact A/D Screen .....	4.16
Check Hardware Screen .....	4.17
Check Key Screen .....	4.17
Check LED Screen .....	4.19
Check LCD Screen .....	4.19
Check Recorder Screen .....	4.19
Check Time Constant Screen .....	4.20
Check Buzzer Screen .....	4.21
Check Memory Screen .....	4.21
Check Voice Screen .....	4.22
Check ECG Frequency Screen .....	4.23
A/D View Screen .....	4.24
Operation Time Screen .....	4.24
Version Up Screen .....	4.25
Debug Mode Screen .....	4.25
Check String Screen .....	4.26
Memory Dump Screen .....	4.26
Periodic Replacement Schedule .....	4.27
Maintenance Check Sheet .....	4.28

**This page is intentionally left blank.**



## General

Check the following items to keep the defibrillator in optimal condition. You can check each function and adjust the settings of the defibrillator in the System Maintenance screen. The maintenance check sheet is provided at the end of this section. Use this sheet to check the defibrillator after any component is replaced.

### Daily Checks

Check the following items every day. Refer to “Basic Checks” in Section 2 of the Operator’s manual).

- Discharge check
- Battery check
- Recorder check
- Alarm check
- Voice check

### Monthly Checks

Check the following items once a month. Refer to “Periodic Check” in Section 10 of the Operator’s manual)

- External paddles
- Energy discharge Test
- Checking energy charge at 270 J and disarm (Charge and internal discharge)
- Battery test (Check the battery appearance every 6 months.)
- HV capacitor test
- Recorder test
- Date and time adjustment

**NOTE**

- **Make sure that the date and time printed on the recording paper is correct. The date and time on the recording paper are important parts of the medical record.**
- **When the mother board, CPU board or biphasic HV unit is replaced with a new one, do the following adjustment. Refer to “System Maintenance Screen - Adjust AD Screen”.**

**Mother board:**

- **ECG sensitivity and offset**
- **Battery voltage setting**
- **Paddle contact impedance threshold**

**CPU board:**

- **ECG sensitivity and offset**
- **Charge energy, charge time, delivered energy and TTR**
- **Battery voltage setting**
- **Paddle contact impedance threshold**

**Biphasic HV unit:**

- **Charge energy, charge time, delivered energy and TTR**
- **Paddle contact impedance threshold**

**HV capacitor:**

- **Charge energy, charge time, delivered energy and TTR**

## System Maintenance Screen

### CAUTIONS

- The defibrillator cannot perform ECG monitoring and defibrillation when the System Maintenance screen is displayed. You have to turn the power off and then on to perform ECG monitoring and defibrillation.
- Before changing or adjusting a setting in the System Maintenance screen, write down or print out all settings. The settings for defibrillation, ECG waveform acquisition and battery are adjusted in the factory for each defibrillator. If different settings are used, the defibrillator may malfunction.
- You must perform the “Flash Save” procedure in the System Maintenance - Configuration screen after any setting in the Configuration screen and Adjust AD screen is changed or adjusted. The new setting or adjustment is not applied and saved until the “Flash Save” procedure is performed. Otherwise, the “D511” error code appears next time the power is turned on.

When an error is detected when the defibrillator is in the System Maintenance screen mode, the error code is displayed on the upper right corner of this screen.

### Calling Up the System Maintenance Screen

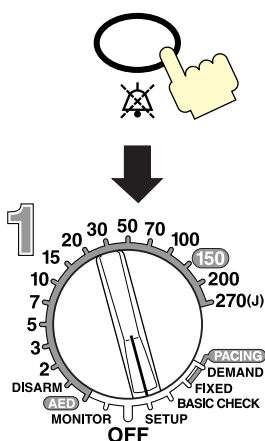

1. Connect the AC power cord
2. While pressing and holding the Silence alarms key, turn the Energy/Mode Select control to the “SETUP” position. The System Setup - Menu screen appears.
3. Release the Silence alarms key.
4. While pressing the Multi-function key, press the following keys on the front panel one by one:  
ECG lead key → Silence alarms key → ECG sensitivity key.  
The System Maintenance - Menu screen appears.

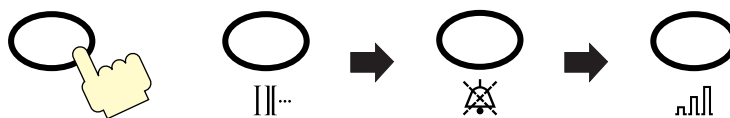

5. Release the Multi-function key.



The function keys at the bottom of the screen change according to the selected screen.

- To call up the sub-screen for each item.
  - 1) Press the Item key to select the item. The cursor moves to the next item.
  - 2) When the item is selected, press the OK key. The menu screen of the selected item appears.
- To exit the System Maintenance Screen, turn the power off by turning the Energy/Mode Select control to the “OFF” position.
- To print the information displayed on the System Maintenance screen, press the record key on the front panel.

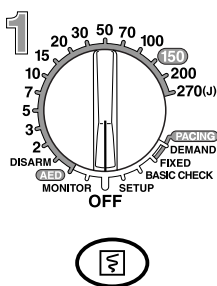

### About the Menu Items

There are eight items in the System Maintenance - Menu screen.

	Screen	Settings
1	Configuration	Changes the settings in the following items: Language, Highcut Filter, Alarm Off Message, Battery Insert Message, DSI Option, Pacing Option, Freeze Function, Use Other Power, Charge Time Clear, Default Setting, Flash Save
2	Adjust AD	Changes the A/D values for ECG waveform acquisition, biphasic HV unit, battery voltage and paddle contact impedance threshold.
3	Check Hardware	Checks the operation of the key switches, LEDs, recorder, memories, sounds, etc
4	AD View	Checks the A/D values that the main CPU currently receives.
5	Operation Time	Displays the count of external discharges and operation time.
6	Version Up	You can update the system program and data
7	Debug mode	Displays the characters used in this defibrillator and checks the flash memory.
8	Alarm Setting	Select “Off” to turn off the ECG, SpO2 and CO2 alarms.

System Maintenance Screen Flowchart

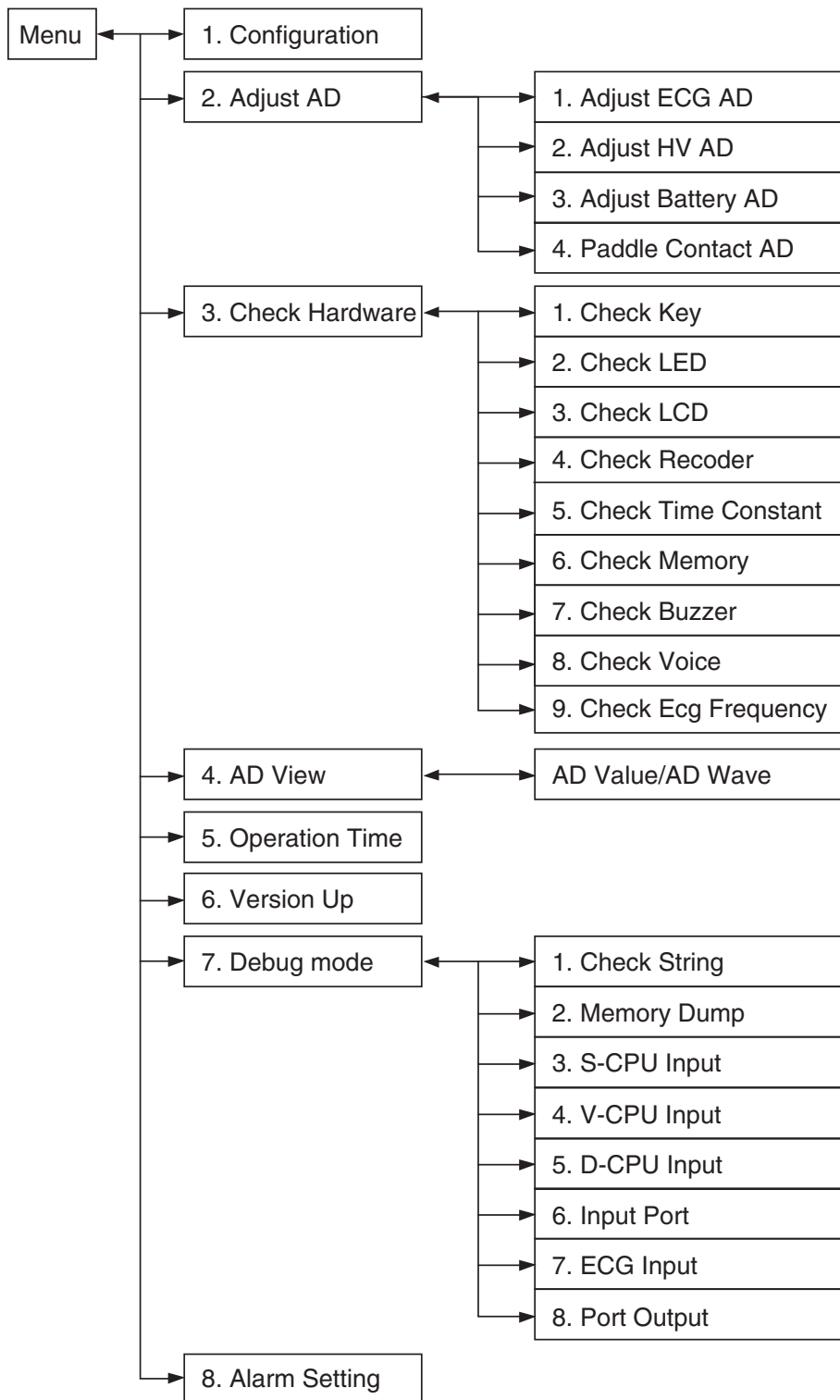

## 4. MAINTENANCE

### Default Settings

The factory default settings are underlined.

Screen	Item	Setting
Configuration	Language	Select the language or country. Selection list: <u>English</u> , Japanese, American, Chinese, Spanish, French, Germany, Italian, Norwegian, Finnish, Other 1 to 5
	Highcut Filter	Select "On" to turn the high-cut filter for ECG measurement. Selection list: On, <u>Off</u>
	Alarm Off Message	Select "On" to display a message when any of the vital alarm settings is set to off. Selection list: <u>On</u> , Off
	Battery Insert Message	Select "On" to display a message when the battery is not in the defibrillator. Selection list: <u>On</u> , Off
	DSI Option	Select "On" when using the optional DSI interface unit and/or DSI/AUXOUT interface unit. Selection list: On, <u>Off</u>
	Pacing Option	On: For the TEC-5531 series defibrillators. Off: For the TEC-5521 series defibrillators
	Freeze Function	Select "On" to enable the freeze function. The ECG second trace can be frozen when the Multi-function key is pressed. Selection list: On, <u>Off</u>
	Use Other Power	Select "On" to supply power from other equipment. Selection list: On, <u>Off</u>
	Charge Times Clear	Deletes the count of external discharges and operation time. Selection list: <u>Off</u> , Exec
	Default Setting	Select "Exec" to return all settings including the alarm settings to the factory default settings. Before doing this operation, write down the necessary settings for each item. Selection list: <u>Off</u> , Exec
	Flash Save	Select "Exec" to save the current settings in the System Maintenance screen in the flash ROM. Selection list: <u>Off</u> , Exec
Adjust AD → Adjust ECG AD	Gain	Adjust the A/D value for the ECG sensitivity. Setting range: 0 to 31 in of 1
	Offset	Adjust the A/D value for the ECG offset at gain $\times 1/4$ , $\times 1/2$ , $\times 1$ , $\times 2$ and $\times 4$ . Setting range: -99 to 99 in steps of 1
Adjust AD → Adjust HV AD	CHARGE AD	Adjust the A/D value to measure the charged energy in the HV capacitor. Setting range: -25 to +25 in steps of 1
	TTR AD	Adjust the A/D value to measure the TTR (transthoracic resistance). Setting range: -25 to +25 in steps of 1
	DELIVERED ENERGY	Adjust the A/D value to measure the delivered energy from the HV capacitor. Setting range: -25 to +25 in steps of 1
	Charge Time (AC)	Adjust the energy charging time in AC operation. Setting range: -5 to +5 in steps of 1
	Charge Time (Batt)	Adjust the energy charging time in battery operation. Setting range: -5 to +5 in steps of 1
Adjust AD → Adjust Battery AD	BATTERY VOLTAGE	Adjust the A/D value of the voltage that is applied to the battery. Setting range: -25 to +25 in steps of 1
Adjust AD → Adjust Paddle Contact AD	100 $\Omega$ , 200 $\Omega$ , 350 $\Omega$	Adjust the A/D value to measure the skin-paddle contact impedance for 100, 200 and 350 $\Omega$ .

The default setting of the following items may differ depending on the defibrillator: Adjust ECG A/D, CHARGE AD, TTR AD, DELIVERED ENERGY, Charge Time, BATTERY VOLTAGE, Paddle Contact AD.

Language	Sync mode after CV	Date format
English, Japanese, Chinese, Spanish, French, Germany, Italian, Norwegian, Finnish, Other 1 to 5	Sync (cardioversion)	YYYY/MM/DD
American	Def (defibrillation)	MMM/DD/YYYY

“Language” sets the language which is used in the defibrillator. The default setting of “Sync mode after CV” (the mode after cardioversion) and “Date format” in the System Setup screen changes according to the selected language.

The default language setting of the defibrillator is set at the factory for the country where the defibrillator is exported to.

## Flash Save Procedure

Do the following procedure when change or adjust any setting in the Configuration screen and Adjust AD screen to save the changed or adjusted setting in memory.

### CAUTIONS

**Do this procedure after any setting in the Configuration screen and Adjust AD screen is changed or adjusted. The new setting or adjustment is not applied and saved until the “Flash Save” procedure is performed. Otherwise, the “D511” error code appears next time the power is turned on.**

1. In the System Maintenance - Menu screen, select “1. Configuration” with the Item key and press the OK key. The System Maintenance - Configuration screen appears.
2. Select “11. Flash Save” with the Item key.
3. Press the → key. The setting changes from “off” to “Exec” and the function keys change as follows:



4. Press the OK key to save the changed or adjusted setting in memory.

To cancel it, press the Cancel key.

To return to the System Maintenance - Menu screen, press the Exit key.

**Configuration Screen**

You can set the several default settings for the defibrillator.

System Maintenance Configuration	
1. Language	English
2. Highcut Filter	Off
3. Alarm Off Message	On
4. Battery Insert Message	On
5. DSI Option	Off
6. Pacing Option	Off
7. Freeze Function	On
8. Use Other Power	Off
9. Charge Times Clear	Off
10. Default Setting	Off
11. Flash Save	Off
Item	← → Exit

To select a setting for “1. Language” to “8. Use Other Power”:

1. Press the Item key to select the item. The cursor moves to the next item.
2. Select the setting with the ← or → key.

The setting changes as follow:

Item	Setting
Language:	English ↔ Japanese ↔ American ↔ Chinese ↔ Spanish ↔ French ↔ Germany ↔ Italian ↔ Norwegian ↔ Finnish ↔ Other 1 to 5
Highcut Filter	On ↔ Off
Alarm Off Message:	On ↔ Off
Battery Insert Message	On ↔ Off
DSI Option:	On ↔ Off
Pacing Option:	On ↔ Off
Freeze Function:	On ↔ Off
Use Other Power:	On ↔ Off

3. Do the Flash Save Procedure to save the changed setting in memory. Refer to “Flash Save Procedure” in this section.

---



---

### CAUTIONS

**Do this procedure after any setting in the Configuration screen is changed or adjusted. The new setting or adjustment is not applied and saved until the “Flash Save” procedure is performed. Otherwise, the “D511” error code appears next time the power is turned on.**

---



---



To perform an item from “9. Charge Time Clear” to “11. Flash Save”

1. Press the Item key to select the item. The cursor moves to the next item.
2. Press the → key. The setting changes from “off” to “Exec” and the function key changes as follow:



3. Press the OK key to perform the selected item.  
To cancel it, press the Cancel key.

To return to the System Maintenance - Menu screen, press the Exit key.

## Adjust AD Screen

You can adjust the ECG sensitivity, charge energy, charge time, delivered energy, TTR and battery voltage settings by changing the A/D value for each item.

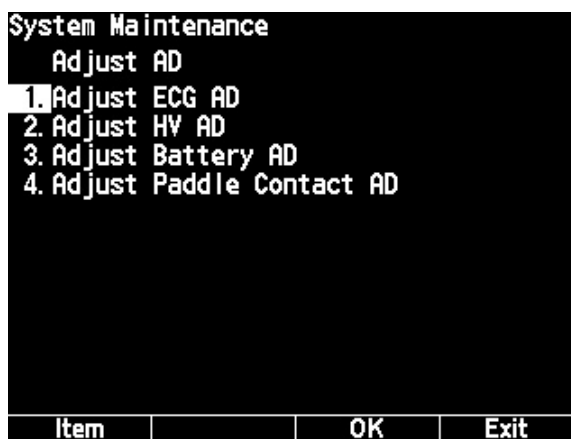

- To call up a sub-screen, select the item with the Item key and OK key.
- To return to the System Maintenance - Menu screen, press the Exit key.

**Adjust ECG A/D Screen**

You can adjust the A/D value for the ECG offset and ECG sensitivity with the automatic adjustment mode or manual adjustment mode

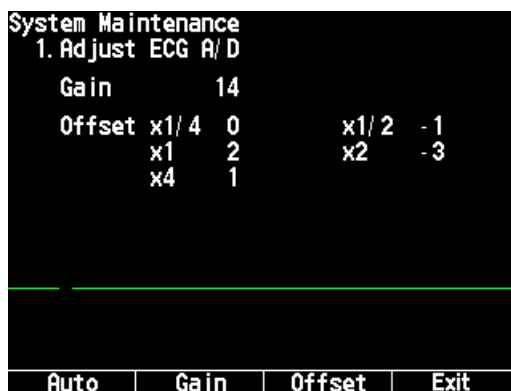

Automatic adjustment mode:

1. Apply a 2 mVp-p, 10 Hz sine wave between lead R (RA) and L (LA)/F (LF).
2. Press the Auto key.

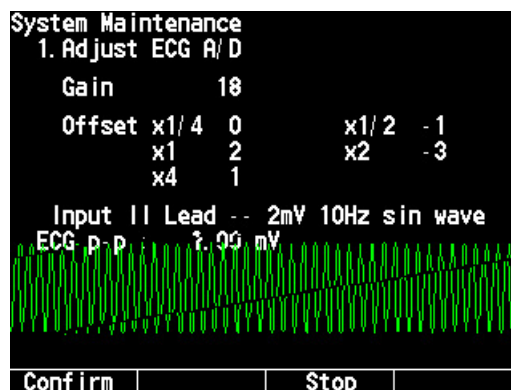

3. When the sine waves appear on the screen, press the Confirm key.

To stop adjustment, press the Stop key.

The ECG sensitivity and ECG offset are automatically adjusted. The temporary A/D values are determined and displayed in the upper right corner of the screen.

4. Do the Flash Save Procedure to save the changed setting in the flash memory. Refer to "Flash Save Procedure" in this section.

---



---

### CAUTIONS

**Do this procedure after adjusting the ECG sensitivity and offset, The new settings are not applied and saved until the "Flash Save" procedure is performed. Otherwise, the "D511" error code appears next time the power is turned on.**

---



---

Manual adjustment mode:

Adjust the amplitude and/or baseline of the sine wave on the screen or paper to 2 cm with the Down and Up key. You can print the ECG A/D screen during adjustment by pressing the record key (To stop recording press the record key again). The temporary A/D values are determined and displayed in the upper right corner of the screen.



## 1. Adjust ECG sensitivity.

- 1) Apply a 2 mVp-p, 10 Hz sine wave between lead R (RA) and L (LA)/F (LF).
- 2) Press the Gain key.

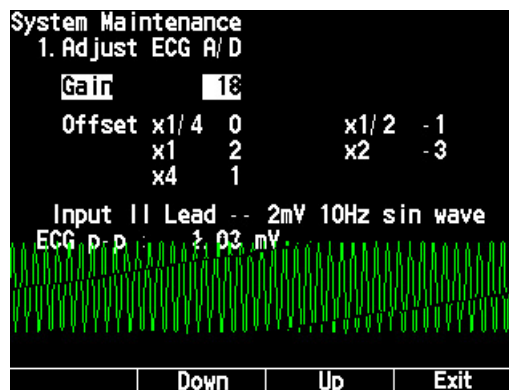

- 3) Adjust the amplitude of the sine wave with the Down and Up key.

## 2. Adjust ECG Offset

- 1) Press the Offset key at gain  $\times 1/4$ .
- 2) Adjust the baseline with the Down and Up key.

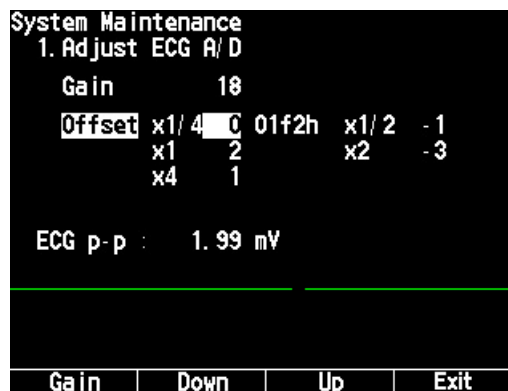

- 3) Do step 2) for gain  $\times 1/2$ ,  $\times 1$ ,  $\times 2$  and  $\times 4$ . To change the sensitivity, use the Gain key.

3. Do the Flash Save Procedure to save the changed setting in the flash memory. Refer to “Flash Save Procedure” in this section.

---



---

### CAUTIONS

**Do this procedure after adjusting the ECG sensitivity and offset, The new settings are not applied and saved until the “Flash Save” procedure is performed. Otherwise, the “D511” error code appears next time the power is turned on.**

---



---

**Adjust HV AD Screen**

You can adjust the settings for delivered energy, TTR, charged energy and charging time. To adjust the charging time, a new fully charged battery or power supply is necessary (required voltage: 13 V, 15 A).

System Maintenance			
2. Adjust HV AD			0J
SELECT 200J			0J
1.			
2.	CHARGE AD		- 3
3.	TTR AD	0ohm	4
4.	DELIVERED ENERGY	0J	3
5.	Charge Time( AC)		0
6.	Charge Time( Batt)		0
			0. 00s
Item			Exit

**WARNING**

This procedure must be performed when the delivered energy is out of the following range when you check delivered energy with the required delivery checker after replacing the HV capacitor and biphasic HV unit.

Selected energy level	Allowable delivered energy range on the delivery checker
2 J	± 0.5 J
3 J	± 1 J
5, 7, 10 J	± 2 J
20 J or more	± 10%

Required delivery checker:

- Nihon Kohden AX-103V, or
- Dynatec Impulse 4000

The checker must be checked for accuracy and performance every year by its manufacturer or approved electrical safety organization.

1. Check and adjust the charged energy.
  - 1) When the Adjust HV AD screen is selected, the “SELECT 200J” message appears on the screen. Place the external paddles on the electrode plate of the delivery checker.
  - 2) Turn the Energy/Mode Select control on the front panel to 200 J. The “PUSH CHARGE KEY” message appears and the selected energy is displayed beside the message.
  - 3) Press the CHARGE button on the APEX external paddle or the CHARGE/AED button on the front panel. The charged energy is displayed in the upper right corner of the screen and the elapsed time from starting charging is displayed in the lower right corner of the screen.
  - 4) When the energy charging is complete, the “PUSH DISCHARGE KEY” message appears. Press both DISCHARGE buttons on the external paddles.
  - 5) Check the delivered energy displayed on the delivery checker. If the delivered energy is not 200 J, continue the adjustment procedure.
  - 6) Select “2. CHARGE AD” with the Item key. The function keys change as follow.



- 7) Press the ↑ or ↓ key to change the energy that will be charged in the capacitor at the 200 J setting. The new CHARGE AD value is displayed beside “2. CHARGE AD” (Setting range: -25 to +25, The default setting is 0).
- 8) Select “1.” and repeat steps 2) to 7) until the delivered energy displayed on the delivery checker is as close as possible to 200 J.

The charging time is automatically measured and displayed at the lower corner of the screen. (within 3 seconds when the energy is set to 200 J)

2. Adjust the AD values for the TTR and delivered energy measurement
  - 1) Select “3. TTR AD” with the Item key.
  - 2) Press the ↑ or ↓ key so that the TTR value displayed beside “3. TTR AD” is as close as possible to 50 Ω.
  - 3) Select “4. DELIVERED ENERGY” with the Item key.
  - 4) Press the ↑ or ↓ key so that the delivered energy displayed beside “4. DELIVERED ENERGY” is close as possible to 200 J.

3. If the charging time is not within 3 seconds, do the following steps.

---

---

### WARNING

**Do not repeatedly charge and discharge the energy. Otherwise, the defibrillator may heat up.**

---

---

For AC operation:

- 1) Do steps 1) to 5) in procedure 1.
- 2) Select “5. Charge Time (AC)” with the Item key.
- 3) Press the ↑ or ↓ key to change the charging time. (Setting range: -5 to +5).
- 4) Repeat steps 1) to 3) until the charging time is as close as possible to 3 seconds but not less than 3 seconds.

For battery operation:

- 5) Use a new fully charged battery or apply 13 V, 15 A from a power supply to the CNA501 battery cable connector (Red wire: +, Black wire: GND).
  - 6) Disconnect the AC power cord from the defibrillator and AC outlet.
  - 7) Do steps 1) to 5) in procedure 1.
  - 8) Select “6. Charge Time (Batt)” with the Item key.
  - 9) Press the ↑ or ↓ key to change the charging time. (Setting range: -5 to +5).
  - 10) Repeat steps 7) to 9) until the charging time is as close as possible to 3 seconds but not less than 3 seconds.
4. Do the Flash Save Procedure to save the changed settings in the flash memory. Refer to “Flash Save Procedure” in this section.

---

---

### CAUTIONS

**Do this procedure after adjusting the charge energy, charge time delivered energy and TTR. The new settings are not applied and saved until the “Flash Save” procedure is performed. Otherwise, the “D511” error code appears next time the power is turned on.**

---

---

### Adjust Battery AD Screen

Adjusts the A/D values of the battery voltage that is applied to the battery pack. To adjust the A/D value of the battery voltage, a power supply is necessary (required voltage: 11.5V).

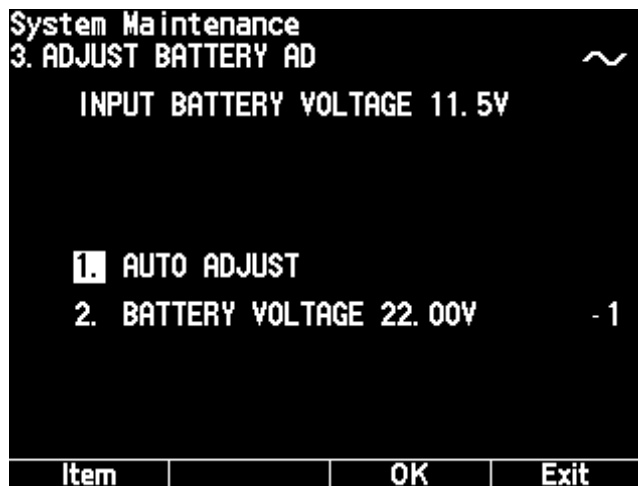

1. Remove the battery pack from the defibrillator. Make sure that the power is turned off and the AC power cord is disconnected from the defibrillator and AC outlet before removing the battery.
2. Apply 11.5 V from a DC power supply to the CNA501 battery cable connector (Red wire: +, Black wire: GND).
3. Call up the System Maintenance - Adjust Battery AD screen.
4. Automatic adjustment mode:  
Select "1. AUTO ADJUST" with the Item key and press the OK key. The voltage that is applied to the battery pack is automatically adjusted. The temporary A/D value is determined and displayed beside "2. BATTERY VOLTAGE 11.50 V".

Manual adjustment mode:

- 1) Select "2. BATTERY VOLTAGE XX.XX V" with the Item key. The function keys change as follows.



- 2) Adjust the A/D value with the ↑ or ↓ key so that the "XX.XX" display becomes 11.50 V.
5. Do the Flash Save Procedure to save the changed settings in the flash memory. Refer to "Flash Save Procedure" in this section.

---

### CAUTIONS

**Do this procedure after adjusting the battery voltage. The new settings are not applied and saved until the "Flash Save" procedure is performed. Otherwise, the "D511" error code appears next time the power is turned on.**

---

**Paddle Contact A/D Screen**

Adjusts the AD values to determine the threshold of the skin-paddle contact impedance.

System Maintenance	
4. Paddle Contact A/ D	
Connect 100ohm	0022h
<b>1.</b> 100ohm	0251h
2. 200ohm	02bdh
3. 350ohm	035bh
<b>Item</b>	<b>Decide</b> <b>Exit</b>

1. Connect the resistance that you want to adjust between the external paddles.
2. Select the resistance with the Item key.
3. Press the Decide key. The temporary A/D value to determine the threshold of the skin-contact impedance is automatically adjusted and displayed beside the selected resistance.
4. Do the Flash Save Procedure to save the changed settings in the flash memory. Refer to “Flash Save Procedure” in this section.

---



---

### CAUTIONS

**Do this procedure after adjusting the paddle contact impedance threshold. The new settings are not applied and saved until the “Flash Save” procedure is performed. Otherwise, the “D511” error code appears next time the power is turned on.**

---



---



## Check Hardware Screen

You can check the function of following hardware in the defibrillator.

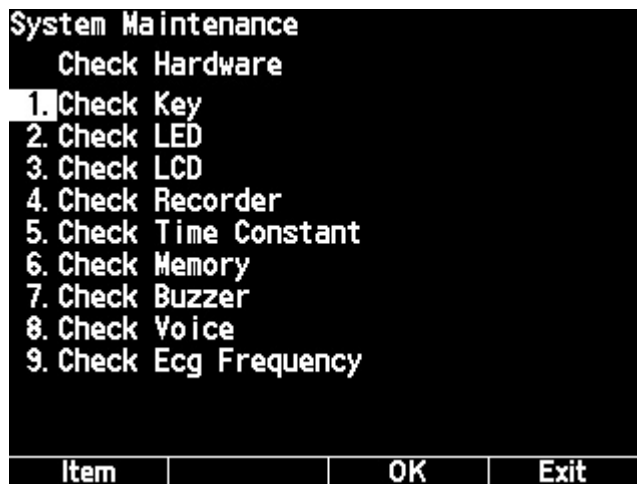

- To call up a sub-screen, select the item with the Item key and OK key.
- To return to the System Maintenance - Check Hardware screen, press the Exit key.
- To return to the System Maintenance - Menu screen, press the Exit key.

## Check Key Screen

You can check the function of the rotary switches, keys, paddle, etc. in this screen.

This screen displays the status of rotary switches, keys, paddle, etc. by highlighting the part names or displaying the status.

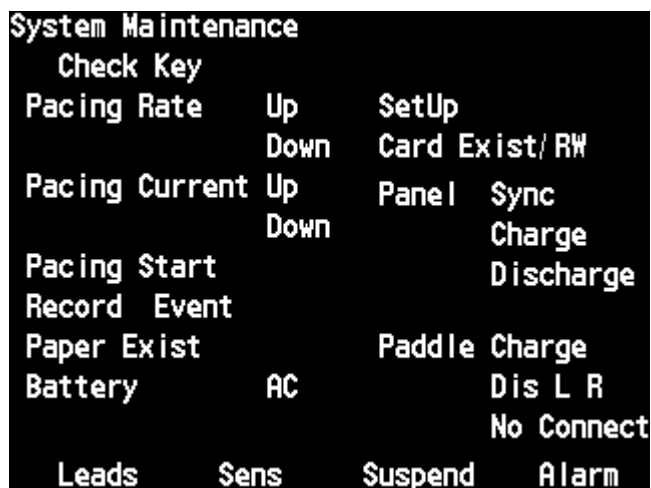

To return to the System Maintenance - Check Hardware screen, press the Alarm key (Multi-function key).

## 4. MAINTENANCE

Check items in the Check Key screen

Part Name	Description
Pacing Rate Up/Down	Highlighted when the PACING RATE Up or Down key on the top panel is pressed. (TEC-5531 series only).
Pacing Current Up/Down	Highlighted when the PACING OUTPUT Up or Down key on the top panel is pressed. (TEC-5531 series only).
Pacing Start	Highlighted when the START/STOP key on the top panel is pressed (TEC-5531 series only).
Record	Highlighted when the record key is pressed.
Event	Highlighted when the event key is pressed.
Paper Exit or Out of Paper	Shows whether the recording paper is set or not.
Battery or No Battery	Shows whether the battery pack is installed or not.
AC	AC: Displayed when the AC power cord is connected to the defibrillator DC: Displayed when the AC power cord is not connected to the defibrillator.
SetUp	Shows the status of the Energy/Mode Select control.
Card exist or No Card	Shows whether an SD card is inserted into the SD card slot.
Panel Sync	Highlighted when the SYNC button on the front panel is pressed.
Panel Charge	Highlighted when the CHARGE/AED button on the front panel is pressed.
Panel Discharge	Highlighted when the DISCHARGE button on the front panel is pressed.
Paddle Charge	Highlighted when the CHARGE button on the apex external paddle is pressed.
Paddle Dis L	Highlighted when the left DISCHARGE button on the sternum external paddle is pressed.
Paddle Dis R	Highlighted when the right DISCHARGE button on the apex external paddle is pressed.
External	Shows the type of the connected paddle. Displays "No Connect" when no paddle is connected.
DSI 1, DSI 2 or DSI 1 2	DSI 1, DSI 2: Displayed when SpO <sub>2</sub> adapter or CO <sub>2</sub> sensor kit is connected to the left or right SpO <sub>2</sub> /CO <sub>2</sub> connector. DSI 1 2: Displayed when SpO <sub>2</sub> adapter and CO <sub>2</sub> sensor kit are connected to the SpO <sub>2</sub> /CO <sub>2</sub> connectors.
Leads	Highlighted when the ECG lead key is pressed.
Sens	Highlighted when the ECG sensitivity key is pressed.
Suspend	Highlighted when the Silence alarms key is pressed.
Alarm	Highlighted when the Multi-function key is pressed, then the System Maintenance - Check Hardware screen is displayed.

### Check LED Screen

You can check the LED function on the defibrillator. The LED lights when the item is selected and On key is pressed. When “Auto” is selected, all LEDs are checked and lit one by one.

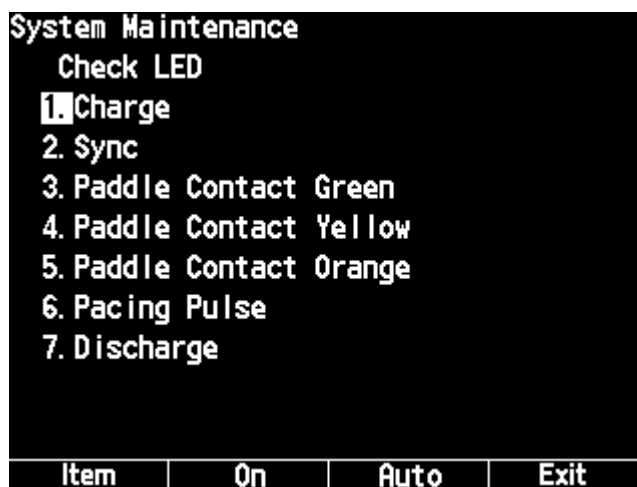

### Check LCD Screen

You can check the LCD screen. When “3. Check LCD” on the System Maintenance - Check Hardware screen is selected and the OK key is pressed, the screen is displayed in green.

Every time you press the ECG lead key, the screen color changes as follows:  
green → green → blue → white → pink → orange → green → white → black → green

To return to the System Maintenance - Check Hardware screen, press the Exit key.

### Check Recorder Screen

You can check the recorder in the Check Recorder screen. When checking starts, the following waveforms are printed, then the character strings are printed.

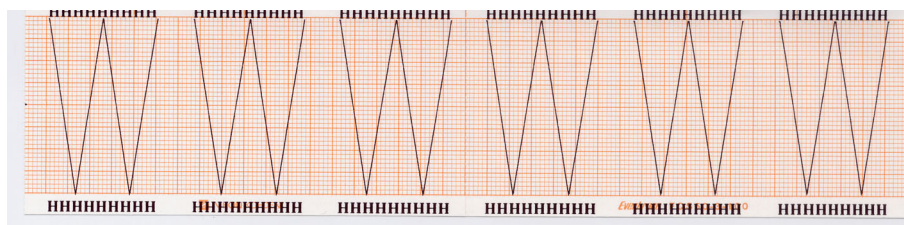

### NOTE

To print all character strings, a lot of recording paper is used. Stop recording, if necessary.

**Check Time Constant Screen**

You can check the time constant of the ECG amplifier.

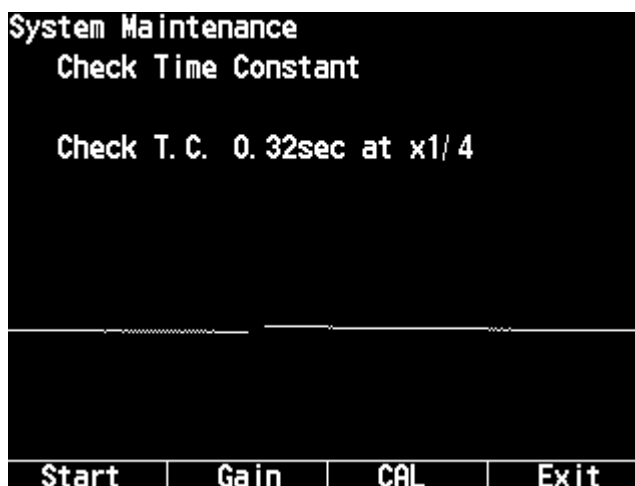

Automatic check mode:

When the Start key is pressed, the defibrillator checks the time constant 0.32 and 3.2 by changing the sensitivity 1/4, 1/2, 1, 2 and 4. The check result is automatically printed on the paper.



To stop checking, press the Stop key

Manual check mode:

You can check the time constant by printing the calibration waveforms on the paper.

- To apply the calibration waveforms, press the CAL key.
- To change the time constant and sensitivity, press the Gain key. Every time you press the Gain key, the time constant and sensitivity change as follows:
  - time constant: 0.32 s, sensitivity: 1/4 →
  - time constant: 0.32 s, sensitivity: 1/2 →
  - time constant: 0.32 s, sensitivity: 1 →
  - time constant: 0.32 s, sensitivity: 2 →
  - time constant: 0.32 s, sensitivity: 4 →
  - time constant: 3.2 s, sensitivity: 1/4 →
  - time constant: 3.2 s, sensitivity: 1/2
  - time constant: 3.2 s, sensitivity: 1 →
  - time constant: 3.2 s, sensitivity: 2 →
  - time constant: 3.2 s, sensitivity: 4 →

### Check Memory Screen

When the Start key is pressed, the defibrillator checks the flash memory and DRAM. During checking, the checked capacity (%) is displayed.

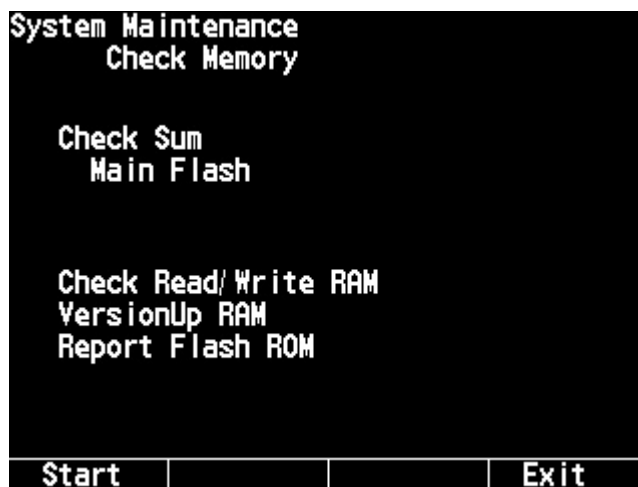

- To start checking, press the Start key.
- To stop checking, press the Stop key.

### Check Buzzer Screen

You can check the sound generated by the defibrillator. The voice prompt can be checked in the Check Voice screen.

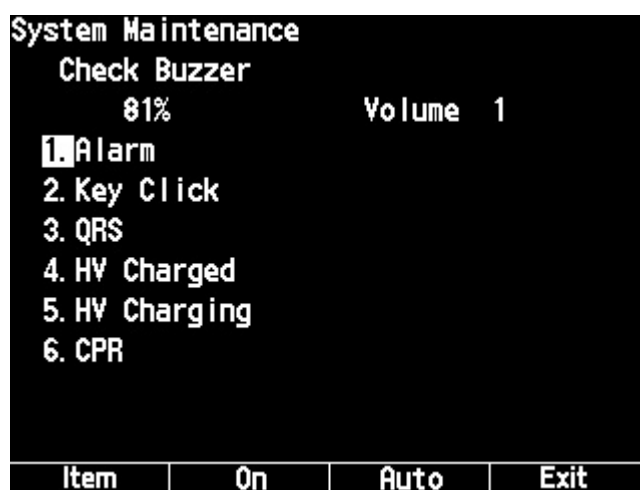
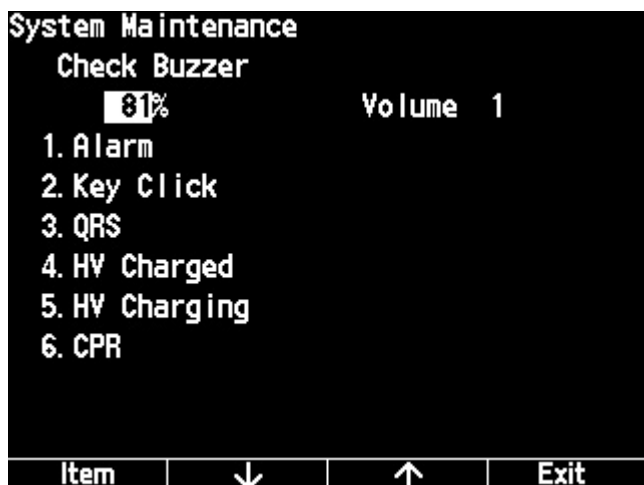

#### Automatic check mode

The sound for each item is generated for 1 second, item by item.

To start checking, select “1. Alarm” with the Item key and press the Auto key. In “3. QRS”, the pitch of the QRS sound is automatically changed from 81 to 100%, then returned to 81%.

#### NOTE

When “3. QRS”, “6. CPR” is selected and the “On” key is repeatedly pressed, each sound may be not heard. This is because each sound does not continue for 1 second.

#### Manual check mode

Select the sound with the Item key and press the On key. The sound for each item is generated for 1 second.

#### Volume:

You can change the pitch and volume of the QRS sound with the ↓ or ↑ key.

### Check Voice Screen

The voice prompt can be checked in this screen.

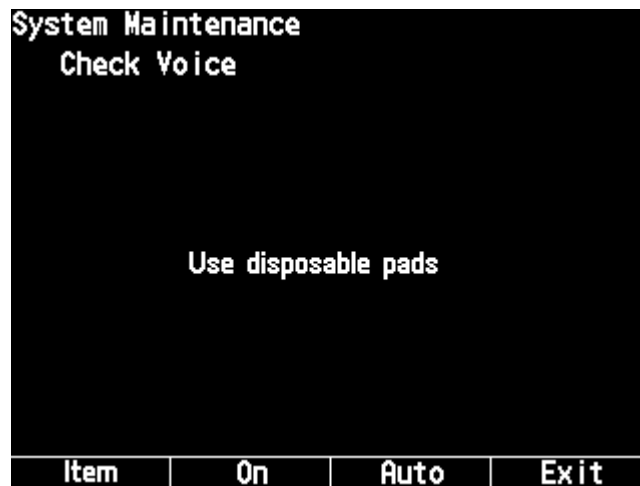

You can manually check the voice prompt by selecting the voice prompt with the Item key, then pressing the On key. When the Auto key is pressed, all voice prompts are checked one by one.

List of voice prompts:

- Use disposable pads
- Connect paddle
- SYNC
- Check disposable pads
- Press CHARGE/AED button
- If no pulse, press CHARGE/AED button
- Check patient
- Stand clear and press DISCHARGE buttons
- Defibrillation not necessary. Check ECG.
- If no pulse, start CPR
- Check pulse
- Stand clear
- Defibrillation necessary. Check ECG.

**Check ECG Frequency Screen**

You can check the frequency response when acquiring the ECG waveforms from the external paddles, internal paddles, disposable pads or ECG disposable electrodes (lead II). The maximum and minimum amplitude are calculated and displayed on the screen.

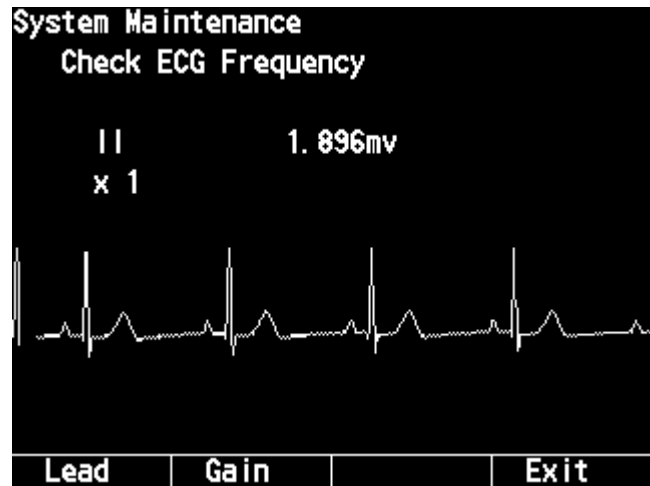
**Setting**

AC line filter: Paddle lead - On, Lead II - Off

Time constant: 0.32 seconds

Sensitivity: To change the sensitivity, use the Gain key. The sensitivity can be selected from  $\times 1/4$ ,  $\times 1/2$ ,  $\times 1$ ,  $\times 2$  and  $\times 4$ .



To print the check result, press the record key on the front panel.

#### 4. MAINTENANCE

### A/D View Screen

This screen displays each AD value that the main CPU currently receives. You can display the A/D wave screen for each AD value by selecting the item with the Item key, then pressing the Exec key.

System Maintenance			
A/D View			
1. ECG	23	0x021d	
2. Charge	-1	0x0001	
3. Battery voltage	-1	0x0396	
4. Battery temperature		0x0271	
5. Recorder temperature		0x01f4	
6. Pacing current		0x0000	
7. Discharge 1		0x0000	
8. Discharge 2		0x7fff	
Item		Exec	Exit

System Maintenance			
A/D View			
9. Relay drive error		0x007b	
10. Monitor error		0x0000	
11. Paddle Contact		0x0023	
Item		Exec	Exit



AD Wave screen

To return to the A/D View screen, press the Exit key.

To return to the System Maintenance - Menu screen, press the Exit key.

### Operation Time Screen

This screen displays the count of external discharges and operation time.

System Mainten Operation Time			
Discharge Times			
2- 150J	68		
200- 270J	0		
Operation Time	3h52m		
			Menu

To return to the System Maintenance - Menu screen, press the Menu key.



### Version Up Screen

This screen is used to update programs and data for the defibrillator with a version up card. When a version up card is inserted into the SD card slot, the program versions of the defibrillator and upgrade card are displayed in the upper right corner of the screen. "None" is displayed for items that are not updated.

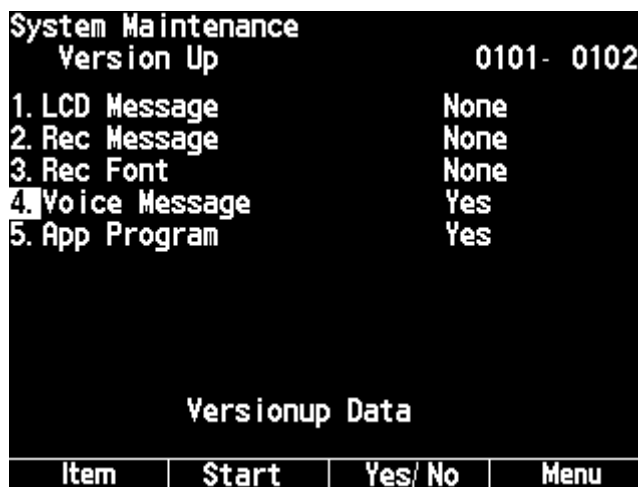

Program version and message

Card type	Version	Message	Function key
Program card	Instrument < Version up card	Versionup	Start
	Instrument > Version up card	Versiondown	Confirm
Data card	-----	Versionup	Start

To return to the System Maintenance - Menu screen, press the Menu key. When updating the system program, turn the power off when the "Success Version Up" message is displayed.

### Debug Mode Screen

The following screen are for factory use only.

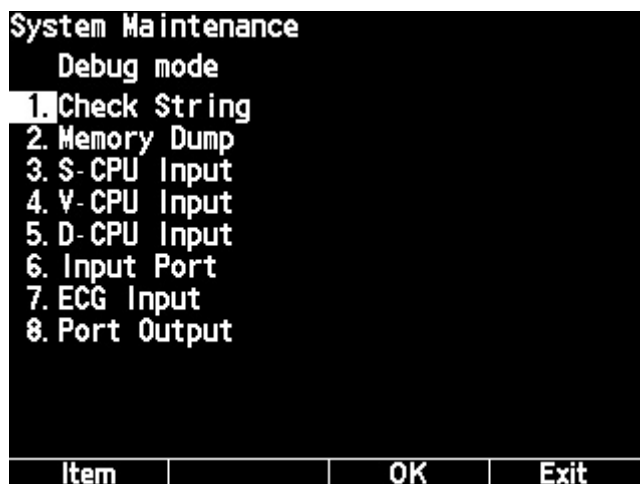

### Check String Screen

This screen is used to check the characters used in the defibrillator. You can display the language which is selected in “Language” (System Maintenance - Configuration screen) by pressing the Language key.

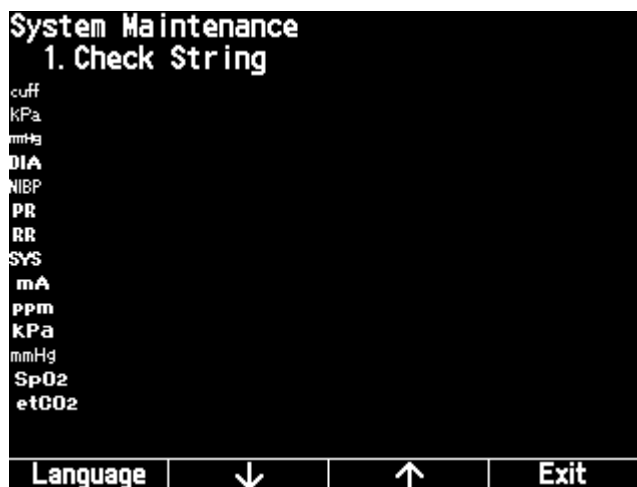

- To scroll the characters, use the ↓ or ↑ key.
- To return to the System Maintenance - Debug Mode screen, press the Exit key.

### Memory Dump Screen

This screen is used to check the flash memory. The address and data can be displayed.

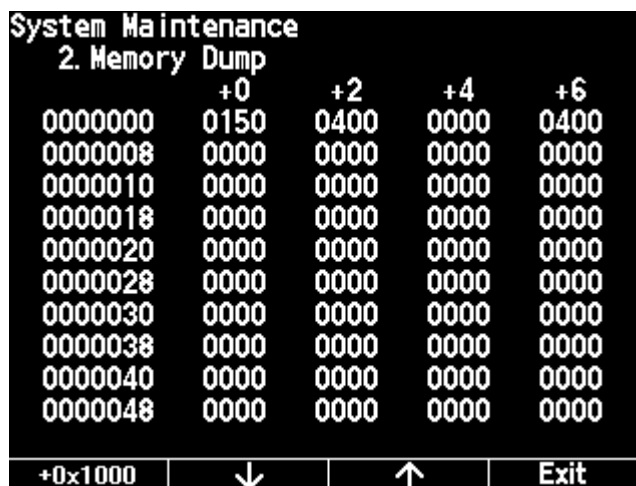

- To display the next 1000H, press the +0x1000 key
- To display the previous or next 50H, use the ↓ or ↑ key.
- To return to the System Maintenance - Debug Mode screen, press the Exit key.

## Periodic Replacement Schedule

To maintain the performance of the defibrillator, the following parts must be periodically replaced by qualified service personnel.

<b>Battery Pack, YZ-024H9</b>	<b>Every year</b>
<b>Pad Adapter, JC-755V</b>	<b>Every two years</b>
<b>Pad Adapter, JC-765V</b>	<b>Every two years</b>

---



---

### CAUTION

**Before disposing of the battery, check with your local solid waste officials for recycling options or proper disposal.**

---



---

### Reference

Fuses on the mother board

<u>Part No.</u>	<u>Code No.</u>	<u>Description</u>
F0501	606168	4 A
F0504	606117	15 A

# Maintenance Check Sheet

## Maintenance Check Sheet

1/2

Date: \_\_\_\_\_

Customer: \_\_\_\_\_

Customer Address: \_\_\_\_\_

Service Personnel: \_\_\_\_\_ Service Company: \_\_\_\_\_

Instrument Name: \_\_\_\_\_ Instrument Model: \_\_\_\_\_

Instrument Serial Number: \_\_\_\_\_ Hardware Revision: \_\_\_\_\_

Software Revision: \_\_\_\_\_

<b>Overview</b>	Outside of instrument is clean.	Yes	<input type="checkbox"/>	No	<input type="checkbox"/>
	No loose screws.	Yes	<input type="checkbox"/>	No	<input type="checkbox"/>
	No physical damage, no bent parts and no contact with liquid.	Yes	<input type="checkbox"/>	No	<input type="checkbox"/>
	Operation panel is not torn or broken.	Yes	<input type="checkbox"/>	No	<input type="checkbox"/>
	All keys, buttons and controls are undamaged.	Yes	<input type="checkbox"/>	No	<input type="checkbox"/>
	Power cord, cables and pins of the paddle connector are not frayed and are correctly connected to the instrument.	Yes	<input type="checkbox"/>	No	<input type="checkbox"/>
<b>Accessories</b>	Paddles, pads and cables prepared.	Yes	<input type="checkbox"/>	No	<input type="checkbox"/>
	Enough recording paper.	Yes	<input type="checkbox"/>	No	<input type="checkbox"/>
	Sterilized internal paddle electrode prepared, if necessary.	Yes	<input type="checkbox"/>	No	<input type="checkbox"/>
	Enough disposable pads, if necessary.	Yes	<input type="checkbox"/>	No	<input type="checkbox"/>
	Enough contact gel (GELAID).	Yes	<input type="checkbox"/>	No	<input type="checkbox"/>
	Enough disposable electrodes.	Yes	<input type="checkbox"/>	No	<input type="checkbox"/>
<b>Installation</b>	Instrument is installed in the proper location.	Yes	<input type="checkbox"/>	No	<input type="checkbox"/>
	Specified 3-prong power cord.	Yes	<input type="checkbox"/>	No	<input type="checkbox"/>
	Battery is in the instrument.	Yes	<input type="checkbox"/>	No	<input type="checkbox"/>
	Recording paper is loaded.	Yes	<input type="checkbox"/>	No	<input type="checkbox"/>
	Options are correctly installed in the instrument.	Yes	<input type="checkbox"/>	No	<input type="checkbox"/>
<b>Power on</b>	There is no fire, smoke or smell.	Yes	<input type="checkbox"/>	No	<input type="checkbox"/>
	There is no electrical shock when touching the instrument.	Yes	<input type="checkbox"/>	No	<input type="checkbox"/>
	Instrument is not abnormally hot.	Yes	<input type="checkbox"/>	No	<input type="checkbox"/>
	Instrument does not affect surrounding equipment.	Yes	<input type="checkbox"/>	No	<input type="checkbox"/>
	AC lamp lights when the AC power is supplied.	Yes	<input type="checkbox"/>	No	<input type="checkbox"/>
	Battery charge lamp lights when the AC power is supplied.	Yes	<input type="checkbox"/>	No	<input type="checkbox"/>
<b>Basic operation</b>	The screen display is correct. (brightness, no distortion)	Yes	<input type="checkbox"/>	No	<input type="checkbox"/>
	Lamp indication is correct.	Yes	<input type="checkbox"/>	No	<input type="checkbox"/>
	All keys, buttons and control operate properly.	Yes	<input type="checkbox"/>	No	<input type="checkbox"/>
	All settings are correct.	Yes	<input type="checkbox"/>	No	<input type="checkbox"/>
	The battery is fully charged.	Yes	<input type="checkbox"/>	No	<input type="checkbox"/>
	Alarm functions properly.	Yes	<input type="checkbox"/>	No	<input type="checkbox"/>
	There is no error message or abnormal operation.	Yes	<input type="checkbox"/>	No	<input type="checkbox"/>

## Maintenance Check Sheet

2/2

**Defibrillation function**

Synchronized cardioversion and defibrillation function is correct.	Yes <input type="checkbox"/>	No <input type="checkbox"/>
Output energy value is proper.	Yes <input type="checkbox"/>	No <input type="checkbox"/>
Time to charge a selected energy is proper.	Yes <input type="checkbox"/>	No <input type="checkbox"/>
Charged energy can be changed to another value.	Yes <input type="checkbox"/>	No <input type="checkbox"/>
The defibrillator properly disarms.	Yes <input type="checkbox"/>	No <input type="checkbox"/>
Energy discharge test is correct.	Yes <input type="checkbox"/>	No <input type="checkbox"/>
Continuity of the paddles and paddle cables is correct.	Yes <input type="checkbox"/>	No <input type="checkbox"/>

**Monitoring**

ECG waveform display is correct.	Yes <input type="checkbox"/>	No <input type="checkbox"/>
The continuity of the ECG connection cable is correct.	Yes <input type="checkbox"/>	No <input type="checkbox"/>
Heart rate display is correct.	Yes <input type="checkbox"/>	No <input type="checkbox"/>
QRS sync mark is displayed and heart rate sync sound generates.	Yes <input type="checkbox"/>	No <input type="checkbox"/>
ECG lead and sensitivity can be changed properly.	Yes <input type="checkbox"/>	No <input type="checkbox"/>
Alarm setting and alarm function is correct.	Yes <input type="checkbox"/>	No <input type="checkbox"/>
Sound volume can be changed properly.	Yes <input type="checkbox"/>	No <input type="checkbox"/>

**Recorder**

Paper is fed correctly (no wandering or jam).	Yes <input type="checkbox"/>	No <input type="checkbox"/>
Waveforms and letters are clearly recorded.	Yes <input type="checkbox"/>	No <input type="checkbox"/>
Time printed on the recording paper is correct.	Yes <input type="checkbox"/>	No <input type="checkbox"/>

**Pacing (TEC-5531 series only)**

Pacing pulse rate and intensity can be set properly.	Yes <input type="checkbox"/>	No <input type="checkbox"/>
The continuity of the pad adaptor cable is correct.	Yes <input type="checkbox"/>	No <input type="checkbox"/>
FIXED and DEMAND mode function is correct.	Yes <input type="checkbox"/>	No <input type="checkbox"/>

**This page is intentionally left blank.**

# *Section 5 Replaceable Parts List*

Replaceable Parts List .....	5.2
------------------------------	-----

**This page is intentionally left blank.**



When ordering parts or accessories from your nearest Nihon Kohden Corporation distributor, please quote the NK code number and part name which are listed in this service manual, and the name or model of the unit in which the required part is located. This will help us to promptly attend to your needs. Always use Nihon Kohden parts and accessories to assure maximum performance from your defibrillator.

## Replaceable Parts List

No.	Code No.	Q'ty	Description
1	6123-900191	1	Operation panel
2	6123-900458	1	Defibrillation operation panel for TEC-5521C
	6123-900476		Defibrillation operation panel for TEC-5521E
	6123-900378		Defibrillation operation panel for TEC-5521K
	6123-900467		Defibrillation operation panel for TEC-5531C
	6123-900485		Defibrillation operation panel for TEC-5531E
	6123-900226		Defibrillation operation panel for TEC-5531K
3	6123-900565	1	Defibrillation instruction panel for C version
	6123-900556		Defibrillation instruction panel for E version
	6123-900253		Defibrillation instruction panel for K version
4	6123-900547	1	Battery instruction label for C version
	6123-900538		Battery instruction label for E version
	6123-900289		Battery instruction label for K version
5	6123-900494	1	Defibrillation caution label for TEC-5521C
	6123-900502		Defibrillation caution label for TEC-5521E
	6123-900342		Defibrillation caution label for TEC-5521K
	6123-900529		Defibrillation caution and pacing label for TEC-5531C
	6123-900511		Defibrillation caution and pacing label for TEC-5531E
	6123-900315		Defibrillation caution and pacing label for TEC-5531K
6	6124-900082	1	Blank panel label
9	6141-900032	1	Upper casing assy
10	6111-900169	1	Front panel assy
11	6113-900771	1	Battery holder cover
12	6111-900178	1	Side casing
13	6114-901073	1	Lock plate for knob
14	6114-901082	1	Knob
15	6114-901108	1	Connector cover (for CNA501 cable)
16	6113-900806	1	Rubber switch (defibrillation)
17	6114-901091	1	Test load cap
18	6114-900653	1	AC SOURCE socket holder
19	6112-900211	1	Front chassis
20	6112-900167	1	Main shield plate 1
21	6112-900158	1	Main shield plate 2
22	6114-900706	2	HV capacitor holder
23	6114-900715	1	Speaker holder
24	6114-900813	1	LCD filter
25	6114-900724	1	Speaker sponge 1
26	6114-900733	1	Speaker sponge 2
27	6114-900742	1	Speaker sponge 3
28	6114-900584	1	Shield sheet
29	6114-900689	1	Drip proof sheet
30	383354	2	Spacer bolt, UN18-2102-0031 (L40)
33	658958	1	O-ring, S10
34	107546	1	O-ring, B-2401 (P-9)
35	128131	6	Spacer bolt, UN18-2102-0004 (L8)

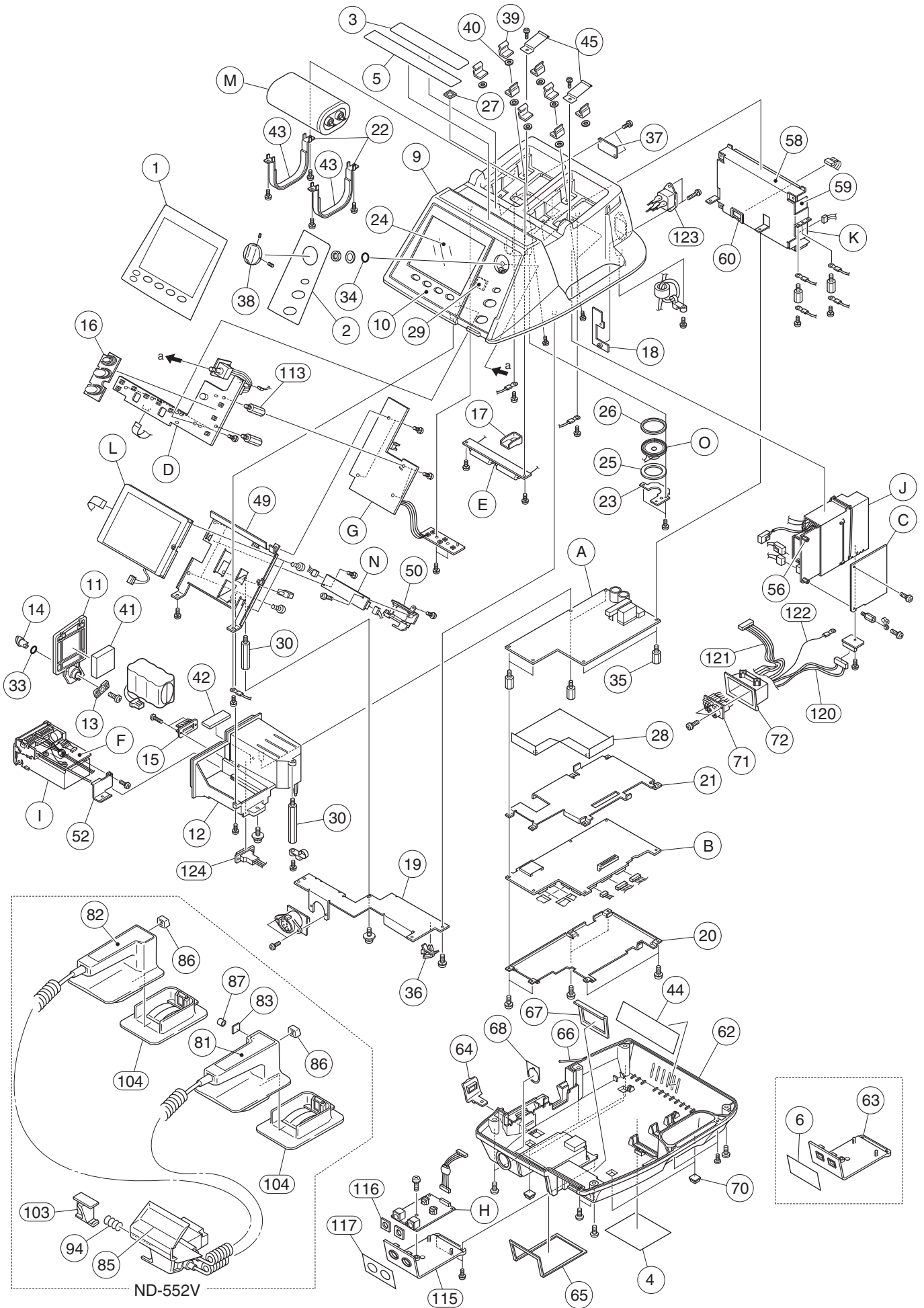

## 5. REPLACEABLE PARTS LIST

No.	Code No.	Q'ty	Description
36	534022	2	Cable tie, LWS-03S
37	6114-118321B	1	ZB blank panel
38	6113-041521C	1	Energy/Mode Select control knob
39	6114-069677A	8	Paddle lock spring, K-718
40	6114-035802A	8	Paddle lock gasket
41	6114-123431C	1	Battery sponge 1
42	6114-901429	2	Battery sponge (5500)
43	6114-118357C	2	HV capacitor sponge
44	6114-118161C	1	Drip proof sheet 2
45	6114-124377A	2	Test electrode plate, T0.2
49	6112-900185	1	LCD chassis
50	6113-041584C	1	Inverter unit cover
52	6114-900698	1	Recorder unit bracket
56	128069	2	Spacer bolt, UN18-2101-005 (L9)
58	6112-900149	1	AC/DC unit chassis (included in CY-0028 power assy)
59	6113-900575	1	Shield sheet for AC/DC unit (included in CY-0028 power assy)
60	458621	1	Edge holder, EH-18U (included in CY-0028 power assy)
62	6111-900151	1	Lower casing
63	6113-900798	1	DSI blank panel
64	6113-900815	1	SD card cover
65	6114-900662	1	DSI panel gasket
66	6114-900751	1	Lower casing gasket
67	6114-118134D	1	Paddle socket gasket
68	6114-118143D	1	ECG connector gasket
70	6114-093614	4	Rubber foot
71	6113-002466B	1	Paddle socket insulator
72	6113-041512C	1	Paddle socket housing
81	6124-037648	1	Apex paddle label for C version
	6124-036408A		Apex paddle label for E version
	6124-034794C		Apex paddle label for K version
82	6124-037639	1	Sternum paddle label for C version
	6124-036444A		Sternum paddle label for E version
	6124-034785B		Sternum paddle label for K version
83	6124-035142	1	Charge button label
85	6112-900274	1	Paddle connector housing
86	6114-123948	2	Discharge button, K-719
87	6114-124207	1	Charge button, K-719
94	1114-174319	1	Lock spring
103	6113-017664E	1	Release knob
104	ND-611V	2	Adult plate assy
113	128042	2	Spacer bolt, UN18-2102-0014 (L18)

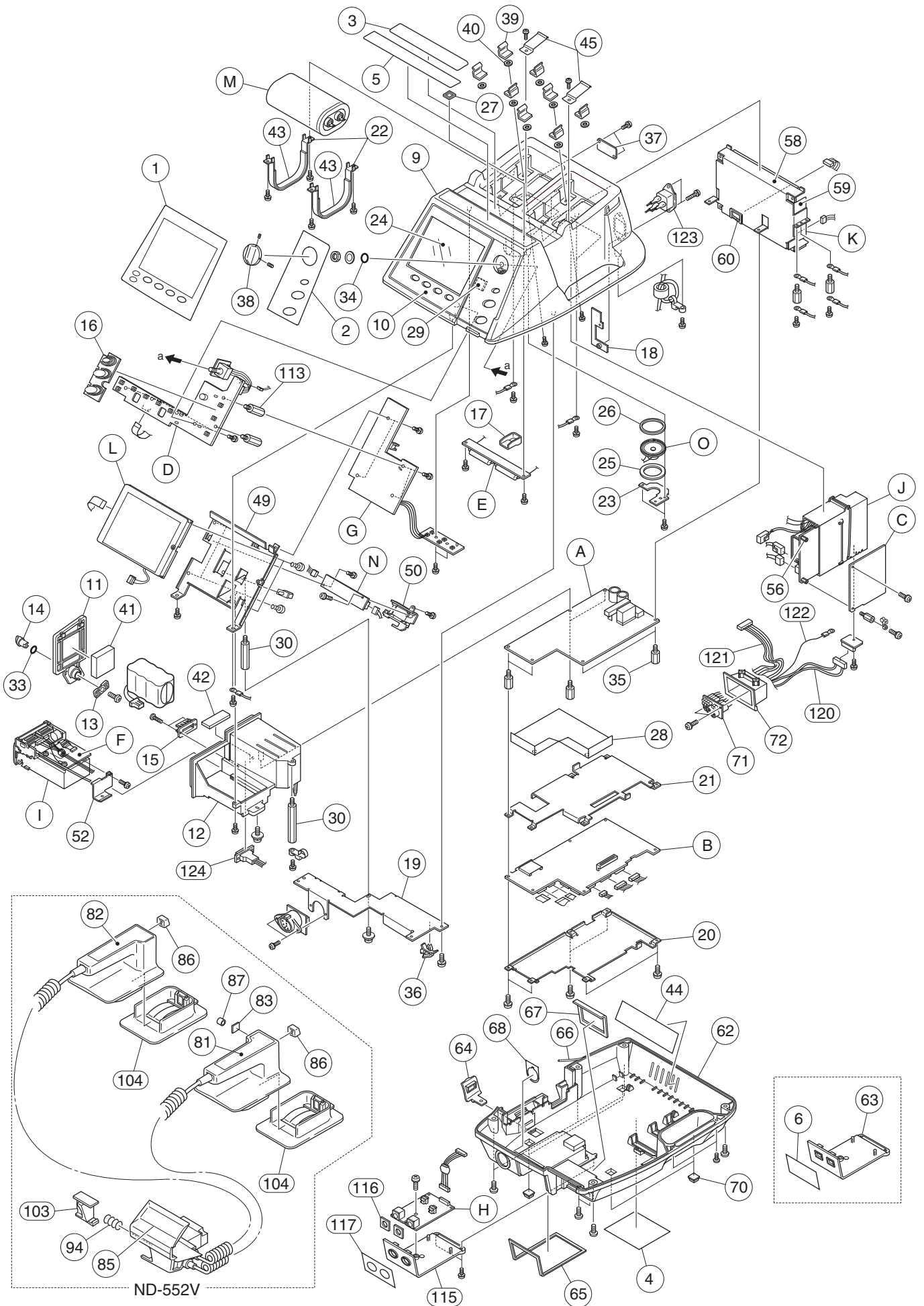

## 5. REPLACEABLE PARTS LIST

No.	Code No.	Q'ty	Description
115	6113-900789	1	DSI panel
116	6114-900671	2	DSI connector gasket
117	6124-900064	1	DSI interface label for QI-552V
	6124-900073		DSI/AUX OUT interface label for QI-553V
120	670953A	1	CAN411 cable, XAP-09V-1/201328-1 (W260)
121	670962	1	CAN 602 cable, DF3-10S-2C/350037-2 (W120)
122	670944	1	CNA002 ground wire, V1.25-3/350037-2 (W260)
123	670917	1	AC SOURCE socket, NC-174-10N/2CON (W165/120)
124	671061	1	CNA501 cable, VHR-10N/3CON (W210/140/170)
A	UR-0313	1	MOTHER board
B	UR-0314	1	CPU board
C	UR-0311	1	HV CPU board (included in HV-552V/553V biphasic HV unit)
D	UR-0316	1	KEY board
E	UR-0315	1	TEST LOAD board
F	UR-0320	1	REC-EXT board (included in WS-551V recorder unit)
G	UR-0304	1	PACER board (TEC-5531 series only)
H	UR-0317	1	DSI FLOAT board
	UR-0318	1	AUX OUT board
I	WS-511V	1	Recorder unit
J	HV-552V	1	Biphasic HV unit for TEC-5521 series
	HV-553V	1	Biphasic HV unit for TEC-5531 series
K	670695A	1	AC/DC unit (included in CY-0028 power assy)
L	672292	1	LCD display (included in CY-0025 LCD assy)
M	669492	1	HV capacitor, NKC-26100B
N	669599	1	LCD INV board (included in CY-0025 LCD assy)
O	671097	1	Speaker

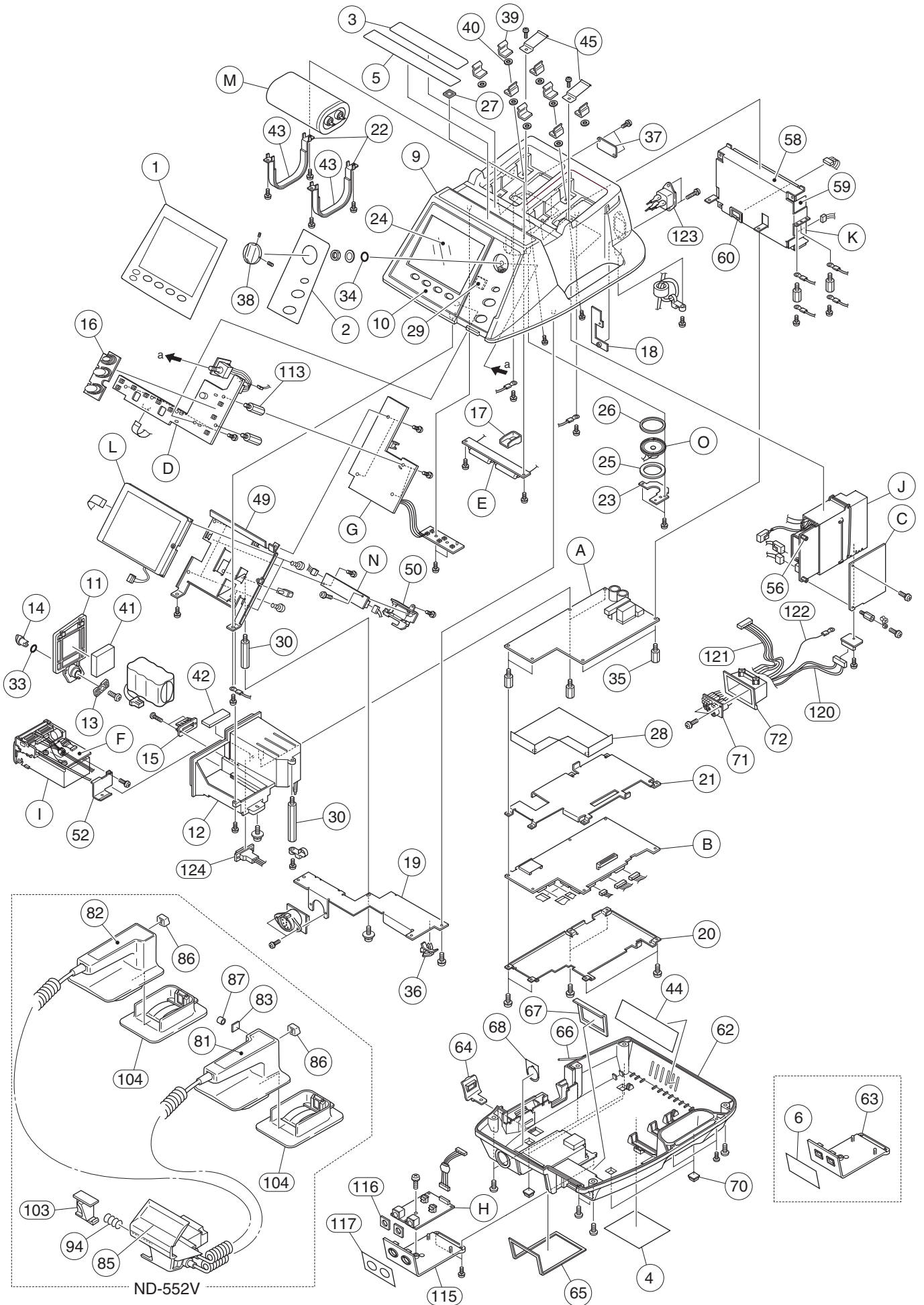

## 5. REPLACEABLE PARTS LIST

**This page is intentionally left blank.**





Manufacturer

**NIHON KOHDEN CORPORATION**

1-31-4 Nishiochiai, Shinjuku-ku  
Tokyo 161-8560, Japan  
Phone +81 (3) 5996-8036  
Fax +81 (3) 5996-8100

**上海维修站**

上海市徐汇区南丹路 169 号 新旺大厦 3008 室  
电话：021-6469-9016 传真：021-6486-7218

**北京维修站**

北京市西城区南礼士路甲 3 号 海通大厦 601 室  
电话：010-6804-9531 传真：010-6804-7366

**广州维修站**

广州市环市东路 371~375 号 世贸中心南塔 1809 室  
电话：020-8761-2726 传真：020-8761-1135

**沈阳维修站**

沈阳市和平区太原北街 20 号  
电话：024-2383-2557 传真：024-2340-2565

**成都维修站**

成都市一环路西二段 17 号 华立大厦 420 室  
电话：028-8779-6330 传真：028-8773-6236

**武汉维修站**

武汉市汉口解放大道 1087 号 梅园大厦 413 室  
电话：027-8360-2368 传真：027-8360-2478

**NIHON KOHDEN AMERICA, INC.**

90 Icon Street, Foothill Ranch, CA 92610, USA  
Phone +1 (949) 580-1555  
Fax +1 (949) 580-1550

**EC REP** European Representative

**NIHON KOHDEN EUROPE GmbH**

Raiffeisenstrasse 10  
D-61191 Rosbach, Germany  
Phone +49 6003 827-0  
Fax +49 6003 827-599

**NIHON KOHDEN ITALIA S.r.l.**

Via San Tomaso 78  
I-24121 Bergamo, Italy  
Phone +39 035 219 543  
Fax +39 035 232 546

**NIHON KOHDEN IBERICA S.L.**

C/ Ulises 75A  
E-28043 Madrid, Spain  
Phone +34 917 161 080  
Fax +34 913 004 676

**NIHON KOHDEN SINGAPORE PTE LTD**

70 Shenton Way, #14-05 Marina House  
Singapore 079118  
Phone +65 6224-6700  
Fax +65 6224-6216

The model and serial number of your instrument are identified on the rear or bottom of the unit. Write the model and serial number in the spaces provided below. Whenever you call your distributor concerning this instrument, mention these two pieces of information for quick and accurate service.

Model \_\_\_\_\_

Serial number \_\_\_\_\_

Your Distributor
------------------