

TECRA

User's Manual

Tecra M2

M2 TECRA M2 TECRA M2 TECRA M2 TECRA M2

Choose freedom.
computers.toshiba-europe.com

TOSHIBA

Copyright

© 2004 by TOSHIBA Corporation. All rights reserved. Under the copyright laws, this manual cannot be reproduced in any form without the prior written permission of TOSHIBA. No patent liability is assumed, with respect to the use of the information contained herein.

TOSHIBA TECRA M2 Portable Personal Computer User's Manual

First edition January 2004

Copyright authority for music, movies, computer programs, data bases and other intellectual property covered by copyright laws belongs to the author or to the copyright owner. Copyrighted material can be reproduced only for personal use or use within the home. Any other use beyond that stipulated above (including conversion to digital format, alteration, transfer of copied material and distribution on a network) without the permission of the copyright owner is a violation of copyright or author's rights and is subject to civil damages or criminal action. Please comply with copyright laws in making any reproduction from this manual.

Disclaimer

This manual has been validated and reviewed for accuracy. The instructions and descriptions it contains are accurate for the TOSHIBA *TECRA M2* Portable Personal Computer at the time of this manual's production. However, succeeding computers and manuals are subject to change without notice. TOSHIBA assumes no liability for damages incurred directly or indirectly from errors, omissions or discrepancies between the computer and the manual.

Trademarks

Intel, Intel SpeedStep, Pentium and Centrino are trademarks or registered trademarks of Intel Corporation.

Windows and Microsoft are registered trademarks of Microsoft Corporation.

Photo CD is a trademark of Eastman Kodak.

Bluetooth is a trademark owned by its proprietor and used by TOSHIBA under license.

i.LINK is trademark and registered trademark of Sony Corporation.

Other trademarks and registered trademarks not listed above may be used in this manual.

EU Declaration of Conformity



This product is carrying the CE-Mark in accordance with the related European Directives. Responsible for CE-Marking is TOSHIBA Europe GmbH, Hammfelddamm 8, 41460 Neuss, Germany.

The complete and official EU Declaration of Conformity can be found on TOSHIBA's web site <http://epps.toshiba-teg.com> on the Internet.

Modem warning notice

Conformity Statement

The equipment has been approved to [Commission Decision "CTR21"] for pan-European single terminal connection to the Public Switched Telephone Network (PSTN).

However, due to differences between the individual PSTNs provided in different countries/regions the approval does not, of itself, give an unconditional assurance of successful operation on every PSTN network termination point.

In the event of problems, you should contact your equipment supplier in the first instance.

Network Compatibility Statement

This product is designed to work with, and is compatible with the following networks. It has been tested to and found to conform with the additional requirements conditional in EG 201 121.

Germany	ATAAB AN005,AN006,AN007,AN009,AN010 and DE03,04,05,08,09,12,14,17
Greece	ATAAB AN005,AN006 and GR01,02,03,04
Portugal	ATAAB AN001,005,006,007,011 and P03,04,08,10
Spain	ATAAB AN005,007,012, and ES01
Switzerland	ATAAB AN002
All other countries/regions	ATAAB AN003,004

Specific switch settings or software setup are required for each network, please refer to the relevant sections of the user guide for more details.

The hookflash (timed break register recall) function is subject to separate national type approvals. It has not been tested for conformity to national type regulations, and no guarantee of successful operation of that specific function on specific national networks can be given.

Description on Laser specification

The optical drive such as DVD-ROM drive, DVD/CD-RW drive, DVD Multi drive and DVD±R/±RW drive that is used in this computer is equipped with laser. The classification label with the following sentence is affixed to the surface of the drive.

CLASS 1 LASER PRODUCT
LASER KLASSE 1
LUOKAN 1 LASERLAITE
APPAREIL A LASER DE CLASSE 1
KLASS 1 LASER APPARAT

The drive with the above label is certified by the manufacturer that the drive complies with the requirement for laser product on the date of manufacturing pursuant to article 21 of Code of Federal Regulations by the United States of America, Department of Health & Human Services, Food and Drug Administration.

In other countries, the drive is certified to comply with the requirement pursuant to IEC 825 and EN60825 on class 1 laser product.

This computer is equipped with the optical drive in the following list according to the model.

Manufacturer	Type
HITACHI	GDR-8082N
TOSHIBA	SD-C2612
TEAC	DW-224E
Panasonic Communications	UJDA750
HITACHI	GCC-4241N
Panasonic Communications	UJ-811B
TEAC	DV-W22E
Pioneer	DVR-K12D

General Precautions

TOSHIBA computers are designed to optimize safety, minimize strain and withstand the rigors of portability. However, certain precautions should be observed to further reduce the risk of personal injury or damage to the computer.

Be certain to read the general precautions below and to note the cautions included in the text of the manual.

Stress injury

Carefully read the *Safety Instruction Manual*. It contains information on prevention of stress injuries to your hands and wrists than can be caused by extensive keyboard use. Chapter 3, *Getting Started*, also includes information on workspace design, posture and lighting that can help reduce physical stress.

Heat injury

- Avoid prolonged physical contact with the computer. If the computer is used for long periods, its surface can become very warm. While the temperature will not feel hot to the touch, if you maintain physical contact with the computer for a long time (if you rest the computer on your lap, or if you keep your hands on the palm rest, for example) your skin might suffer low-heat injury.
- If the computer has been used for a long time, avoid direct contact with the metal plate supporting the I/O ports. It can become hot.
- The surface of the AC adaptor can become hot when in use. This condition does not indicate a malfunction. If you need to transport the AC adaptor, disconnect it and let it cool before moving it.
- Do not lay the AC adaptor on a material that is sensitive to heat. The material could be damaged.

Pressure or impact damage

Do not apply heavy pressure to the computer or subject it to strong impact. Excessive pressure or impact can cause damage to computer components or otherwise cause malfunctions.

PC card overheating

Some PC cards can become hot with prolonged use. Overheating of a PC card can result in errors or instability in the PC card operation. Also be careful when you remove a PC card that has been used for a long time.

Mobile phones

Use of mobile phones can interfere with the audio system. Computer operation is not impaired but is recommended that a distance of 30cm be maintained between the computer and a mobile phone in use.

Central Processing Unit ("CPU") Performance Disclaimer

CPU Performance in your computer product may vary from specifications under the following conditions:

- use of certain peripheral products
- use of battery power instead of AC power
- use of certain multimedia games or videos with special effects
- use of standard telephone lines or low speed network connections
- use of complex modeling software, such as high end computer aided design application
- use of computer in areas with low air pressure (high altitude >1,000 meters or >3,280 feet above sea level)
- use of computer at temperatures outside the range of 5°C to 35°C (41°F to 95°F) or >25°C (77°F) at high altitude (all temperature reference are approximate).

CPU Performance may also vary from specifications due to design configuration.

Under some conditions, your computer product may automatically shut-down. This is a normal protective feature designed to reduce the risk of lost data or damage to the product when used outside recommended conditions. To avoid risk of lost data, always make back-up copies of data by periodically storing it on an external storage medium. For optimum performance, use your computer product only under recommended conditions. Read additional restrictions under "Environmental Requirements" in appendix A. Contact TOSHIBA Service and Support for more information.

CE compliance

This product and the original options are designed to observe the related EMC (Electromagnetic compatibility) and safety standards. However, TOSHIBA should not guarantee that this product still observes these EMC standards if options or cables not produced by TOSHIBA are connected or implemented. In this case the persons who have connected / implemented those options / cables have to assure that the system (PC plus options / cables) still fulfils the required standards. To avoid in general EMC problems following advice should be observed:

- Only CE marked options should be connected / implemented
- Only best shielded cables should be connected

Working environment

This product was designed to fulfil the EMC (electromagnetic compatibility) requirements to be observed for so-called “Residential, commercial and light industry environments”.

TOSHIBA do not approve the use of this product in working environments other than the above mentioned “Residential, commercial and light industry environments”.

For example, the following environments are not approved:

- Industrial Environments (environments with a mains voltage >230V~)
- Medical Environments
- Automotive Environments
- Aircraft Environments



If this product is supplied with a network port, please refer to the paragraph “Network connection”.

Any consequences resulting from the use of this product in working environments that are not approved are not the responsibility of TOSHIBA Europe GmbH.

The consequences of the use of this product in non-approved working environments may be:

- Interference with other devices or machines in the near surrounding area
- Malfunction of, or data loss from, this product caused by disturbances generated by other devices or machines in the near surrounding area

Therefore TOSHIBA strongly recommend that the electromagnetic compatibility of this product should be suitably tested in all non-approved working environments before use. In the case of automobiles or aircraft, the manufacturer or airline respectively should be asked for permission before use of this product.

Furthermore, for general safety reasons, the use of this product in environments with explosive atmospheres is not permitted.

Network connection (class A warning)

If this product has networking capabilities and will be connected to a network, Class A radiation limits will be observed (in accordance with technical conventions). This means that if the product will be used in a domestic environment, other devices in the near surrounding may suffer interference. Consequently, please do not use this product in such environments (for example a living room), otherwise you could be held responsible for any ensuing interference.

Information on the secure use of the CD-RW

Please adhere to the following information on the use of the CD-RW to minimise the risk of unsuccessful storing process. As the storing may be unsuccessful despite your adhering to these information, for example because of a defective storing medium, you should even if the software indicates a successful storage, always check if the data has been stored successfully.

Wireless LAN and your Health

Wireless LAN products, like other radio devices, emit radio frequency electromagnetic energy. The level of energy emitted by Wireless LAN devices however is far much less than the electromagnetic energy emitted by wireless devices like for example mobile phones.

Because Wireless LAN products operate within the guidelines found in radio frequency safety standards and recommendations, TOSHIBA believes Wireless LAN is safe for use by consumers. These standards and recommendations reflect the consensus of the scientific community and result from deliberations of panels and committees of scientists who continually review and interpret the extensive research literature.

In some situations or environments, the use of Wireless LAN may be restricted by the proprietor of the building or responsible representatives of the organisation. These situations may for example include:

- Using the Wireless LAN equipment on board of aeroplanes, or
- In any other environment where the risk of interference to other devices or services is perceived or identified as harmful.

If you are uncertain of the policy that applies on the use of wireless devices in a specific organisation or environment (e.g. airports), you are encouraged to ask for authorisation to use the Wireless LAN device prior to turning on the equipment.

Safety Instruction for Wireless Products

If your computer has wireless function, all safety instructions must be read carefully and must be fully understood, before attempting to use our Wireless Products.

This manual contains the safety instructions that must be observed in order to avoid potential hazards that could result in personal injuries or could damage your Wireless Products.

Limitation of Liability

For damage occurring due to an earthquake or thunder, fire beyond our responsibility, action by third party, other accident, intentional or accidental mistakes by a user, misuse, use under abnormal conditions, we do not take any responsibility.

For incidental damage (loss of business profit, business interruption, etc.) occurring due to use or disability of the product, we do not take any responsibility.

For damage occurring due to non observance of the contents described in the instruction manual, we do not take any responsibility.

For damage occurring due to erroneous operation or hang up caused by use in combination with products not related to our company, we do not take any responsibility.

Usage Restrictions

Do not use the Wireless Products for controlling equipment:

- Equipment directly linked with human life corresponds to the following.
 - Medical equipment such as life support systems, equipment used in operations, etc.
 - Exhaust systems for gases such as poisonous gas etc. and exhaust systems for smoke.
 - Equipment that must be set up in compliance with various laws such as the Fire Services Act, the Construction Standard Act, etc.
 - Equipment corresponding to that mentioned above.
- Equipment linked with human safety or having a serious influence on the safe maintenance of public function, etc., because it is not designed or manufactured for this type of use.
 - Traffic control equipment for air, railroad, road, marine transport, etc.
 - Equipment used in atomic power plants etc.
 - Equipment corresponding to that mentioned above.

WARNING



Turn OFF the Wireless Communication switch of Wireless Products in a congested place, such as a crowded commuter train.

Keep this product away from a cardiac pacemaker at least 22cm.

Radio waves can potentially affect cardiac pacemaker operation, thereby causing respiratory troubles.

Turn OFF the Wireless Communication switch inside a medical facility or near medical electric equipment. Do not bring medical electric equipment close to the product.

Radio waves can potentially affect medical electric equipment, thereby causing an accident due to malfunction.

Turn OFF the Wireless Communication switch near an automatic door, fire alarm or other automatic control equipment.

Radio waves can potentially affect automatic control equipment, thereby causing an accident due to malfunction.

Do not turn ON the Wireless Communication switch in aircraft or in places that generate or can generate radio interference.

Radio waves can potentially affect them, causing an accident due to malfunction.

Monitor possible radio interference or other troubles to other equipment while the product is used. If any effect is caused, turn OFF the Wireless Communication switch.

Otherwise, radio waves can potentially affect other equipment, thereby causing an accident due to malfunction.

When using the product in a car, check with the automobile dealer if the car has an adequate electromagnetic compatibility (EMC).

Radio waves of the product can potentially hamper safe driving.

Depending on car model, the product can rarely affect car electronic equipment if it is used in a car.

NOTE



Do not use the product in the following places:

Places near a microwave oven where a magnetic field generates and places where static electricity or radio interference generates.

Depending on environment, radio waves can not reach to the product.

Table of Contents

General Precautions

Preface

Manual contents	xvi
Conventions	xvii

Chapter 1: Introduction

Equipment checklist	1-1
Features	1-3
Special features	1-10
Utilities	1-13
Options	1-15

Chapter 2: The Grand Tour

Front with the display closed	2-1
Left side	2-2
Right side	2-3
Backside	2-5
Underside	2-6
Front with the display open	2-8
System indicators	2-11
Keyboard indicators	2-12
USB floppy disk drive (optional)	2-13
Optical media drives	2-14
AC adaptor	2-17

Chapter 3: Getting Started

Setting up your work space	3-1
Connecting the AC adaptor	3-4
Opening the display	3-5
Turning on the power	3-6
Windows XP setup	3-7
Turning off the power	3-7
Restarting the computer	3-10
Restoring the preinstalled software	3-11

Chapter 4: Operating Basics

TOSHIBA Dual Pointing Device	4-1
Using the USB floppy disk drive (optional)	4-3
Changing Slim Select Bay modules	4-4
Using optical media drives	4-6
Writing CDs on CD-RW/DVD-ROM drive	4-10
Writing CD/DVDs on DVD Multi drive	4-11
Writing CD/DVDs on DVD±R/±RW drive (DVD Dual drive)	4-12
Media care	4-18
Sound System	4-19
Modem	4-21
Wireless communications	4-24
LAN	4-27
Cleaning the computer	4-28
Moving the computer	4-29
Heat dispersal	4-29

Chapter 5: The Keyboard

Typewriter keys	5-1
F1 ... F12 function keys	5-2
Soft keys: Fn key combinations	5-2
Hot keys	5-4
Windows special keys	5-7
Keypad overlay	5-7
Generating ASCII characters	5-9

Chapter 6: Power and Power-Up Modes

Power conditions	6-1
Power indicators	6-4
Battery types	6-5
Care and use of the battery pack	6-7
Replacing the battery pack	6-13
TOSHIBA Password Utility	6-16
Power-up modes	6-18
Panel power on/off	6-18
System Auto Off	6-18

Chapter 7: HW Setup

Accessing HW Setup	7-1
------------------------------	-----

Chapter 8: Optional Devices

PC cards	8-2
SD cards	8-3
Memory expansion	8-6
Hard disk drive pack	8-13
Additional battery pack	8-15
High capacity battery pack	8-15
Slim Select Bay 2nd battery pack	8-15
Additional AC adaptor	8-16
Battery charger	8-16
Slim Select Bay HDD adaptor	8-16
External monitor	8-17
TV	8-18
Displaying movies on a TV or CRT	8-18
i.LINK (IEEE1394)	8-19
Advanced Port Replicator III	8-21
Parallel printer	8-22
Security lock	8-22

Chapter 9: Troubleshooting

Problem solving process	9-1
Hardware and system checklist	9-3
TOSHIBA support	9-21

Appendix A: Specifications

Appendix B: AC Power Cord and Connectors

Appendix C: Display Controller and Modes

Appendix D: If your computer is stolen

Appendix E: ASCII Character Codes

Appendix F: Wireless LAN

Appendix G: Internal Modem Guide

Glossary

Index

Preface

Congratulations on your purchase of the TECRA M2 computer. This powerful notebook computer provides excellent expansion capability, including multimedia devices, and it is designed to provide years of reliable, high-performance computing.

This manual tells how to set up and begin using your TECRA M2 computer. It also provides detailed information on configuring your computer, basic operations and care, using optional devices and troubleshooting.

If you are a new user of computers or if you're new to portable computing, first read over the *Introduction* and *The Grand Tour* chapters to familiarize yourself with the computer's features, components and accessory devices. Then read *Getting Started* for step-by-step instructions on setting up your computer.

If you are an experienced computer user, please continue reading the preface to learn how this manual is organized, then become acquainted with this manual by browsing through its pages. Be sure to look over the *Special features* section of the Introduction, to learn about features that are uncommon or unique to the computers and carefully read *HW Setup*. If you are going to install PC cards or connect external devices such as a monitor, be sure to read Chapter 8, *Optional Devices*.

Manual contents

This manual is composed of the following nine chapters, seven appendixes, a glossary and an index.

Chapter 1, *Introduction*, is an overview of the computer's features, capabilities, and options.

Chapter 2, *The Grand Tour*, identifies the components of the computer and briefly explains how they function.

Chapter 3, *Getting Started*, provides a quick overview of how to begin operating your computer and gives tips on safety and designing your work area.

Chapter 4, *Operating Basics*, includes instructions on using the following devices: TOSHIBA Dual Pointing Device, USB floppy disk drive, Slim Select Bay modules, optical media drives, sound system, modem, Wireless communication features, and LAN. It also provides tips on care of the computer, diskettes and CD/DVDs.

Chapter 5, *The Keyboard*, describes special keyboard functions including the keypad overlay and hot keys.

Chapter 6, *Power and Power-Up Modes*, gives details on the computer's power resources and battery save modes and how to set a password.

Chapter 7, *HW Setup* explains how to configure the computer using the HW Setup program.

Chapter 8, *Optional Devices*, describes the optional hardware available.

Chapter 9, *Troubleshooting*, provides helpful information on how to perform some diagnostic tests, and suggests courses of action if the computer doesn't seem to be working properly.

The *Appendixes* provide technical information about your computer.

The *Glossary* defines general computer terminology and includes a list of acronyms used in the text.

The *Index* quickly directs you to the information contained in this manual.

Conventions

This manual uses the following formats to describe, identify, and highlight terms and operating procedures.

Abbreviations

On first appearance, and whenever necessary for clarity, abbreviations are enclosed in parentheses following their definition. For example: Read Only Memory (ROM). Acronyms are also defined in the Glossary.

Icons

Icons identify ports, dials, and other parts of your computer. The indicator panel also uses icons to identify the components it is providing information on.

Keys

The keyboard keys are used in the text to describe many computer operations. A distinctive typeface identifies the key top symbols as they appear on the keyboard. For example, **Enter** identifies the Enter key.

Key operation

Some operations require you to simultaneously use two or more keys. We identify such operations by the key top symbols separated by a plus sign (+). For example, **Ctrl + C** means you must hold down **Ctrl** and at the same time press **C**. If three keys are used, hold down the first two and at the same time press the third.

ABC

When procedures require an action such as clicking an icon or entering text, the icon's name or the text you are to type in is represented in the type face you see to the left.

Display



Names of windows or icons or text generated by the computer that appears on its display screen is presented in the type face you see to the left.

Messages

Messages are used in this manual to bring important information to your attention. Each type of message is identified as shown below.



Pay attention! A caution informs you that improper use of equipment or failure to follow instructions may cause data loss or damage your equipment.



Please read. A note is a hint or advice that helps you make best use of your equipment.

Chapter 1

Introduction

This chapter provides an equipment checklist, and it identifies the computer's features, options and accessories.



Some of the features described in this manual may not function properly if you use an operating system that was not preinstalled by TOSHIBA.

Equipment checklist

Carefully unpack your computer. Save the box and packing materials for future use.

Hardware

Check to make sure you have all the following items:

- TECRA M2 Portable Personal Computer
- Universal AC adaptor and power cord
- Modular cable (for modem)
- Spare AccuPoint (pointing device) cap

Software

- The following software is preinstalled:
 - Microsoft® Windows XP Professional
 - Microsoft Internet Explorer
 - Modem driver
 - Display Driver for Windows
 - TOSHIBA Utilities
 - Wireless LAN driver
 - Bluetooth driver
 - TOSHIBA SD Memory Boot Utility
 - Sound Driver for Windows
 - DVD Video Player
 - LAN Driver
 - Infrared Device Driver
 - TOSHIBA Dual Pointing Device utility
 - TOSHIBA Power Saver
 - TOSHIBA Mobile Extension
 - TOSHIBA Console
 - TOSHIBA ConfigFree
 - TOSHIBA Zooming Utility
 - TOSHIBA PC Diagnostic Tool
 - TOSHIBA Controls
 - TOSHIBA IP PHONE
 - TOSHIBA Audio Effect
 - Online manual
- Documentation:
 - *TECRA M2 User's Manual*
 - TECRA M2 Quickstart
 - Microsoft Windows XP manual
 - *Safety Instruction Manual*
 - Warranty information
- Tools & Utilities CD-ROM
- Product Recovery CD-ROM or DVD-ROM

Features

The computer uses TOSHIBA's advanced Large Scale Integration (LSI), Complementary Metal-Oxide Semiconductor (CMOS) technology extensively to provide compact size, minimum weight, low power usage, and high reliability. This computer incorporates the following features and benefits:

Processor

Built-in	The computer is equipped with an Intel® processor, which incorporates a math co-processor, a 32 KB level 1 cache memory and a 1MB level 2 cache memory. It also supports Enhanced Intel® SpeedStep™ technology. Intel® Pentium® M processor 1.4 GHz Intel® Pentium® M processor 1.5 GHz Intel® Pentium® M processor 1.6 GHz Intel® Pentium® M processor 1.7 GHz
-----------------	---



Some models of this series carry Intel® Centrino™ technology, which is based on three separate technologies of Intel® Pentium® M, Intel® PRO/ Wireless Network Connection, and Intel® 855 Chipset Family.

Memory

Slots	The slot accepts a 256, 512 or 1,024 MB memory modules can be installed in the two memory slots for a maximum of 2,048 MB system memory.
Level 2 cache	1MB level 2cache is provided to maximize performance.
Video RAM	32 or 64 MB of RAM is provided for video display.

Power

Battery pack	The computer is powered by one rechargeable lithium-ion battery pack.
RTC battery	The internal RTC battery backs up the Real Time Clock and calendar.

AC adaptor	<p>The universal AC adaptor provides power to the system and recharges the batteries when they are low. It comes with a detachable power cord.</p> <p>Because it is universal, it can receive a range of AC voltage from 100 to 240 volts; however, the output current varies among different models. Using the wrong model can damage your computer. See the <i>AC adaptor</i> section in Chapter 2, The Grand Tour.</p>
-------------------	---

Disks

Hard disk drive	<p>Available in four sizes.</p> <ul style="list-style-type: none"> ■ 30.0 billion bytes (27.94 GB) ■ 40.0 billion bytes (37.26 GB) ■ 60.0 billion bytes (55.88 GB) ■ 80.0 billion bytes (74.52 GB)
USB floppy disk drive (Optional)	<p>Accommodates either 3 1/2" 1.44-megabyte or 720-kilobyte diskettes. It connects to a USB port.</p>



Computers in this series can be configured with an optical media drive installed in the Slim Select Bay. The available optical media drives are described below.

DVD-ROM drive	<p>Some models are equipped with a full-size, DVD-ROM drive module that lets you run either 12 cm (4.72") or 8 cm (3.15") CDs or 12cm(4.72") DVDs without using an adaptor. It runs DVD-ROMs at maximum 8 speed and CD-ROMs at maximum 24 speed. The drive supports the following formats:</p> <ul style="list-style-type: none"> ■ DVD-ROM ■ DVD-Video ■ CD-DA ■ CD-Text ■ Photo CD™ (single/multi-session) ■ CD-ROM Mode 1, Mode 2 ■ CD-ROM XA Mode 2 (Form1, Form2) ■ Enhanced CD (CD-EXTRA) ■ CD-G (Audio CD only) ■ Addressing Method 2
----------------------	--

CD-RW/DVD-ROM drive

Some models are equipped with a full-size, CD-RW/DVD-ROM drive module that lets you run CD/DVDs without using an adaptor. It reads DVD-ROMs at maximum 8 speed and CD-ROMs at maximum 24 speed. It writes CD-R at up to 24 speed and CD-RW at up to 24 speed. For reading, this drive supports the same formats as the DVD-ROM drive.

- DVD-ROM
- DVD-Video
- CD-DA
- CD-Text
- Photo CD™ (single/multi-session)
- CD-ROM Mode 1, Mode 2
- CD-ROM XA Mode 2 (Form1, Form2)
- Enhanced CD (CD-EXTRA)
- CD-G (Audio CD only)
- Addressing Method 2

DVD Multi drive

Some models are equipped with a full-size DVD Multi drive module that lets you record data to rewritable CD/DVDs as well as run either 12cm (4.72") or 8cm (3.15") CD/DVDs without using an adaptor. An ATAPI interface controller is used for CD/DVD-ROM operation. The drive reads DVDs at maximum 8 speed and CDs at maximum 24 speed. It writes DVD-RW at maximum single speed, DVD-R and DVD-RAM at maximum 2 speed, CD-R at maximum 16 speed, and CD-RW at maximum 8 speed (High-speed media). The drive supports the following formats:

- DVD-ROM
 - DVD-Video
 - DVD-R
 - DVD-RW
 - DVD-RAM
 - CD-ROM
 - CD-EXTRA
 - Photo CD™
 - Audio CD
 - CD-ROM XA
 - CD-DA
 - CD-I
 - CD-Text
 - CD-R
 - CD-RW
-

DVD±R/±RW drive (DVD Dual drive)

Some models are equipped with a full-size DVD±R/±RW drive module that lets you record data to rewritable CD/DVDs as well as run either 12cm (4.72") or 8cm (3.15") CD/DVDs without using an adaptor. It reads DVD-ROMs at maximum 8 speed and CD-ROMs at maximum 24 speed. It writes CD-R at up to 16 speed, CD-RW at up to 10 speed, DVD-R and DVD-RW at maximum 2 speed. DVD+R and DVD+RW at maximum 2.4 speed. This drive supports the same formats as the DVD-ROM drive.

- DVD-ROM
- DVD-Video
- DVD-R
- DVD-RW
- DVD+R
- DVD+RW
- CD-DA
- CD-Text
- Photo CD™ (single/multi-session)
- CD-ROM Mode 1, Mode 2
- CD-ROM XA Mode 2 (Form1, Form2)
- Enhanced CD (CD-EXTRA)
- CD-G (Audio CD only)
- Addressing Method 2

Display

The computer's LCD panel supports high-resolution video graphics. The screen can be set at a wide range of viewing angles for maximum comfort and readability.

Built-in

14.1" TFT screen, 16 M colors, with one of the following resolutions:

- XGA, 1024 horizontal x 768 vertical pixels
- SXGA+, 1400 horizontal x 1050 vertical pixels

Graphics controller

Graphics controller maximizes display performance. Refer to *Appendix C* for more information.

Keyboard

Built-in

85 keys or 86 keys, compatible with IBM enhanced keyboard, embedded numeric overlay, dedicated cursor control,  and  keys. See Chapter 5, *The Keyboard*, for details.

TOSHIBA Dual Pointing Device

Built-in Touch pad	A Touch pad and control buttons in the palm rest enable control of the on-screen pointer and scrolling of windows.
Built-in AccuPoint	This pointer control stick, located in the center of the keyboard, provides convenient control of the cursor.

Ports

Parallel	Parallel printer or other parallel device (ECP compatible).
External monitor	15-pin, analog VGA port supports VESA DDC2B compatible functions.
Universal Serial Bus (USB 2.0)	The computer has two Universal Serial Bus ports that comply with the USB 2.0 standard, which enables data transfer speeds 40 times faster than the USB 1.1 standard. (The ports also support USB 1.1.)
Docking interface	This port enables connection of an optional Advanced Port Replicator III described in the <i>Options</i> section.
i.LINK™ (IEEE1394)	This port enables high-speed data transfer directly from external devices such as digital video cameras. Some models are equipped with a i.LINK port.
Infrared	The serial infrared port is compatible with Infrared Data Association (IrDA 1.1) standards. It enables cableless 4 Mbps, 1.152 Mbps, 115.2 kbps, 57.6 kbps, 38.4 kbps, 19.2 kbps or 9.6 kbps data transfer with IrDA 1.1 compatible external devices.

Slots

PC card	The PC card slot accommodates two 5 mm Type II cards or one Type III card.
SD card	This slot lets you easily transfer data from devices, such as digital cameras and Personal Digital Assistants, that use SD card flash-memory. You can use memory module in this slot.

Multimedia

Sound system	Windows sound system compatible sound system provides internal speakers and microphone as well as jacks for an external microphone and headphone.
Video-out jack (S-Video)	This jack lets you transfer video data to external devices. Use an S-Video cable. Data output depends on the type of device connected to the S-Video cable.
Headphone jack	This jack outputs analog audio signals.
Microphone jack	A 3.5 mm mini microphone jack enables connection of a three-conductor mini jack for monaural microphone input.

Communications

Modem	An internal modem provides capability for data and fax communication. The speed of data transfer and fax depends on analog telephone line conditions. It has a modem jack for connecting to a telephone line. Both of V.90 and V.92 are supported only in USA, Canada, UK, France, Germany and Australia. Only V.90 is available in other regions.
LAN	The computer has built-in support for Ethernet LAN (10 megabits per second, 10BASE-T), Fast Ethernet LAN (100 megabits per second, 100BASE-Tx) and Gigabit Ethernet LAN (1000 megabits per second, 1000BASE-T). Some models are equipped with a Gigabit Ethernet LAN.
Bluetooth	Some computers in this series are equipped with Bluetooth functions. Bluetooth wireless technology eliminates the need for cables between electronic devices such as computers and printers. Bluetooth provides fast, reliable, and secure wireless communication in a small space.

Wireless LAN

Some computers in this series are equipped with a Wireless LAN mini-PCI card that is compatible with other LAN systems based on Direct Sequence Spread Spectrum / Orthogonal Frequency Division Multiplexing radio technology that complies with the IEEE 802.11 Standard (Revision A, B or G), and Turbo Mode.

- Automatic Transmit Rate Select mechanism in the transmit range of 54, 48, 36, 24, 18, 12, 9 and 6 Mbit/s. (Revision A/B, B/G, A/B/G combo type)
- Automatic Transmit Rate Select mechanism in the transmit range of 11, 5.5, 2 and 1 Mbit/s. (Revision B)
- Automatic Transmit Rate Select mechanism in the transmit range of 108, 96, 72, 48, 36, 24, 18 and 12 Mbit/s. (Turbo Mode, Revision A/B/G combo type)
- Frequency Channel Selection (5 GHz: Revision A / 2.4 GHz: Revision B/G)
- Roaming over multiple channels
- Card Power Management
- Wired Equivalent Privacy (WEP) data encryption, based on 152 bit encryption algorithm. (Revision B/G, A/B/G combo type).
Wired Equivalent Privacy (WEP) data encryption, based on 128 bit encryption algorithm. (Revision B only type).
- Advanced Encryption Standard (AES) data encryption, based on 256 bit encryption algorithm. (Revision A/B combo, B only type)

Slim Select Bay Modules

Slim Select Bay is a single-drive bay that accommodates a DVD-ROM drive, CD-RW/DVD-ROM drive, DVD Multi drive, DVD±R/±RW drive, secondary hard disk drive or secondary battery pack. The TOSHIBA Mobile Extension enables hot insertion of modules when you are using a plug and play operating system.

Security

Security lock slot	Connects an optional security lock to anchor the computer to a desk or other large object.
Slim Select Bay lock	Slim Select Bay module can be secured by Slim Select Bay lock fixed with a lock screw in the lock position. The lock screw is inserted in the unlock position when purchased.

Software

Operating System	Windows XP Professional operating system and TOSHIBA Utilities and drivers preinstalled on the hard disk. Refer to the <i>Software</i> section at the front of this chapter.
TOSHIBA Utilities	A number of utilities and drivers are preinstalled to make your computer more convenient to use. Refer to the <i>Utilities</i> section in this chapter.
Plug and Play	When you connect an external device to the computer or when you install a component, Plug and Play capability enables the system to recognize the connection and make the necessary configurations automatically.

Special features

The following features are either unique to TOSHIBA computers or are advanced features, which make the computer more convenient to use.

TOSHIBA Console button	Press this button to launch an application automatically. The default is TOSHIBA Console.
TOSHIBA Presentation button	Press this button to change internal display, external display, simultaneous display, or multi-monitor display.
Hot keys	Key combinations let you quickly modify the system configuration directly from the keyboard without running a system configuration program.
Display automatic power off	This feature automatically cuts off power to the internal display when there is no keyboard input for a time specified. Power is restored when any key is pressed. You can specify the time in the <i>Monitor power off</i> item of the <i>Basic Setup</i> tab in TOSHIBA Power Saver.

HDD automatic power off	This feature automatically cuts off power to the hard disk drive when it is not accessed for a time specified. Power is restored when the hard disk is accessed. You can specify the time in the <i>HDD power off</i> item of the <i>Basic Setup</i> tab in TOSHIBA Power Saver.
System automatic Standby/Hibernation	This feature automatically shuts down the system in standby mode or Hibernation mode when there is no input or hardware access for a time specified. You can specify the time and select either System Standby or System hibernation in the <i>System standby and System</i> item of the <i>Basic Setup</i> tab in TOSHIBA Power Saver.
Keypad overlay	A ten-key pad is integrated into the keyboard. Refer to the <i>Keypad overlay</i> section in Chapter 5, <i>The Keyboard</i> , for instructions on using the keypad overlay.
Power on password	Two levels of password security, supervisor and user, are available to prevent unauthorized access to your computer.
Instant security	A hot key function blanks the screen and disables the computer providing data security.
Intelligent power supply	A microprocessor in the computer's intelligent power supply detects the battery's charge and calculates the remaining battery capacity. It also protects electronic components from abnormal conditions, such as voltage overload from an AC adaptor. You can monitor remaining battery capacity. Use the <i>Battery remaining</i> item in TOSHIBA Power Saver.
Battery save mode	This feature lets you save battery power. You can specify the Power Save Mode in the <i>Profile</i> item in TOSHIBA Power Saver.
Panel power on/off	This feature turns power to the computer off when the display panel is closed and turns it back on when the panel is opened. You can specify the setting in the <i>When I close the lid</i> item of the <i>Setup Action</i> tab in TOSHIBA Power Saver.
Low battery automatic hibernation	When battery power is exhausted to the point that computer operation cannot be continued, the system automatically enters Hibernation and shuts down. You can specify the setting in the <i>Setup Action</i> tab in TOSHIBA Power Saver.

Heat dispersal

To protect from overheating, the CPU has an internal temperature sensor. If the computer's internal temperature rises to a certain level, the cooling fan is turned on or the processing speed is lowered. Use the *Fan* item of the *Basic Setup* tab in TOSHIBA Power Saver.

- Maximum Performance Turns on fan first, then if necessary lowers CPU processing speed.
- Performance Uses a combination of fan and lowering the CPU processing speed.
- Battery optimized Lowers the CPU processing speed first, then if necessary turns on the fan.

Hibernation

This feature lets you turn off the power without exiting from your software. The contents of main memory are saved to the hard disk, when you turn on the power again, you can continue working right where you left off. Refer to the *Turning off the power* section in Chapter 3, Getting Started, for details.

Standby

If you have to interrupt your work, you can turn off the power without exiting from your software. Data is maintained in the computer's main memory. When you turn on the power again, you can continue working right where you left off.

Utilities

This section describes preinstalled utilities and tells how to start them. For details on operations, refer to each utility's online manual, help files or readme.txt files.

TOSHIBA Power Saver	To access this power savings management program, click the Control Panel and select the TOSHIBA Power Saver icon.
HW Setup	This program lets you customize your hardware settings according to the way you work with your computer and the peripherals you use. To start the utility, click the Windows Start button and click Control Panel. In the Control Panel, select the TOSHIBA HW Setup icon.
TOSHIBA Controls	This utility have a section to let you do the following: <ul style="list-style-type: none"> ■ Buttons: Assign applications to the Internet button (default setting is the browser) and to the TOSHIBA Console button (default setting is the TOSHIBA Console).
DVD Video Player	The DVD Video Player is used to play DVD-Video. It has an on-screen interface and functions. Click Start, point to All Programs, point to InterVideo WinDVD 4, then click InterVideo WinDVD 4.
Bluetooth TOSHIBA Stack	This software enables communication between remote Bluetooth devices.



Bluetooth cannot be used in models that do not have a Bluetooth module installed.

TOSHIBA SD Memory Boot Utility	The TOSHIBA SD memory boot utility is a utility which can create SD memory card to a boot disk. You can boot TOSHIBA SD Memory Boot Utility from the menu bar as follows. <ul style="list-style-type: none"> ■ [Start] - [All Programs] - [TOSHIBA] - [Utility] - [SD Memory Boot Utility]
TOSHIBA Zooming Utility	This utility allows you to enlarge or reduce the icon size on the desktop or the application widow.

Drag'n Drop CD+DVD	This easy-to-use software lets you record CD/DVDs with just a few mouse clicks. You can create CD/DVDs in several formats including audio CDs that can be played on a standard stereo CD player and data CDs to store the files and folders on your hard drive. This software can be used on a model with CD-RW/DVD-ROM drive, DVD Multi drive and DVD±R/±RW drive.
TOSHIBA Console	TOSHIBA Console is a graphical user interface that provides easy access to help and services. It is the default function launched by the TOSHIBA Console button.
TOSHIBA PC DiagnosticTool	TOSHIBA PC Diagnostic Tool displays the basic information on PC, and the test of built-in devices can also be performed. You can boot TOSHIBA PC Diagnostic Tool from the menu bar as follows <ul style="list-style-type: none">■ [Start] - [All Programs] - [TOSHIBA] - [Utilities] - [PC Diagnostic Tool]
TOSHIBA Mobile Extension	This utility enables hot insertion of Slim Select Bay modules, that is, you can remove/insert Slim Select Bay modules while the computer is on. To activate this utility, select TOSHIBA Mobile Extension from TOSHIBA Console.
TOSHIBA ConfigFree	ConfigFree is a suite of utilities to allow easy control of communication device and network connections. ConfigFree also allows you to find communication problems and create profiles for easy switching between location and communication networks. You can boot ConfigFree from the menu bar as follows. <ul style="list-style-type: none">■ [Start] - [All Programs] - [TOSHIBA] - [Networking] - [ConfigFree]
TOSHIBA Dual Pointing Device utility	This utility has the following functions: To disable/enable TOSHIBA Dual Pointing Device with Fn + F9 keys. To customize the functions of TOSHIBA Dual Pointing Device easily.
TOSHIBA IP Phone	TOSHIBA IP Phone lets you call an IP Phone, use answering machine function, send and receive text message while you're talking. You can boot TOSHIBA IP Phone from the menu bar as follows. <ul style="list-style-type: none">■ [Start] - [All Programs] - [TOSHIBA] - [RealtimeCommunication] - [IPPhone]

TOSHIBA Audio Effect	This utility provides you with a hands-free environment for holding mutual communication via the Internet Protocol or Local Area Network. Refer to the <i>Sound system</i> section in Chapter 4, <i>Operating Basics</i> , for details.
-----------------------------	---

Options

You can add a number of options to make your computer even more powerful and convenient to use. The following options are available:

Memory expansion	A 256, 512 or 1,024 MB memory module (PC2100 / PC2700 DDR) can easily be installed in the computer.
Battery pack	An additional battery pack can be purchased from your TOSHIBA dealer. Use it as a spare or replacement.
High capacity battery pack	An additional battery pack can be purchased from your TOSHIBA dealer. Use it as a spare or replacement.
AC adaptor	If you use your computer at more than one site frequently, it may be convenient to purchase an additional AC adaptor for each site so you will not have to carry the adaptor with you.
Battery charger	The battery charger lets you charge extra batteries outside the computer.
Security lock	A slot is available to attach a security cable to the computer to deter theft.
USB FDD Kit	A 3 1/2" floppy disk drive accommodates 1.44-megabyte or 720-kilobyte diskette. It connects to a USB port. (You cannot format 720-kilobyte diskettes on Windows XP, but you can use previously formatted disks.)

Advanced Port Replicator III	The Advanced Port Replicator III provides the ports available on the computer in addition to separate PS/2 mouse and PS/2 keyboard ports, a digital visual interface (DVI) port, i.LINK™ (IEEE1394) port, line-in jack and line-out jack, External monitor port, Universal Serial Bus port (USB2.0) × 4, LAN jack, Modem jack.
Hard disk drive	You can increase your computer's data storage capacity with additional hard disk drives. They are available in the following sizes: <ul style="list-style-type: none"> ■ 30 billion bytes (27.94 GB) ■ 40 billion bytes (37.26 GB) ■ 60 billion bytes (55.88 GB) ■ 80 billion bytes (74.52 GB)
Wireless LAN Kit	This option enables wireless LAN functions in computers that do not have wireless preinstalled. It is installed by dealers only.
Bluetooth Kit	This option enables Bluetooth wireless communications in computers that do not have Bluetooth preinstalled. It is installed by dealers only.

Slim Select Bay options

The following modules can be installed in the Slim Select Bay. All other modules are options.

DVD-ROM	Refer to the <i>Features</i> section for details.
CD-RW/DVD-ROM	Refer to the <i>Features</i> section for details.
DVD Multi	Refer to the <i>Features</i> section for details.
DVD±R/±RW (DVD Dual drive)	Refer to the <i>Features</i> section for details.
Slim Select Bay HDD adaptor (Black)	An adaptor lets you install an optional HDD described in Chapter 8, <i>Optional Devices</i> .
Hard disk drive	You can increase your computer's data storage capacity with an additional 30 billion bytes (27.94 GB), 40 billion bytes (37.26 GB), 60 billion bytes (55.89 GB) and 80 billion bytes (74.52 GB) hard disk drive in the Slim Select Bay HDD adaptor.

**Slim Select Bay
2nd battery pack**

The secondary battery increases your computer's battery power and operating time when a main battery is also installed.

Chapter 2

The Grand Tour

This chapter identifies the various components of your computer. Become familiar with each component before you operate the computer.

Front with the display closed

The figure below shows the computer's front with its display panel in the closed position.

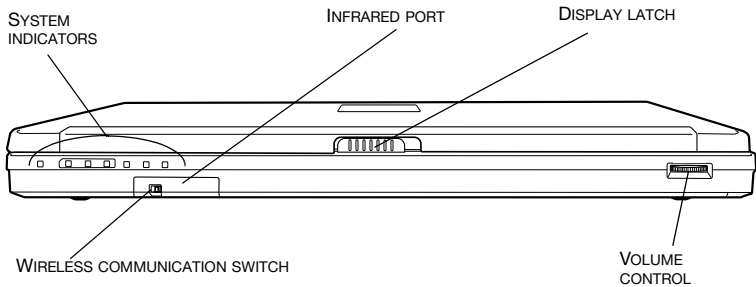

Front of the computer with display closed

System indicators	LEDs let you monitor the status of various computer functions. Details are given in the <i>Indicators</i> section.
Display latch	This latch secures the LCD panel in its closed position. Slide the latch to open the display.
Volume control	Use this dial to adjust the volume of the stereo speakers and the stereo headphones.
Infrared port	This infrared port is compatible with Infrared Data Association (IrDA 1.1) standards. It enables cableless 4 Mbps, 1.15 Mbps, 115.2 kbps, 57.6 kbps, 38.4 kbps, 19.2 kbps or 9.6 kbps data transfer with IrDA 1.1 compatible external devices.





Wireless communication switch

Slide this switch to the left to turn off Wireless LAN and Bluetooth functions. Slide it to the right to turn on the functions (Wireless model or Wireless LAN ready model only).

Left side

The figure below shows the computer's left side.

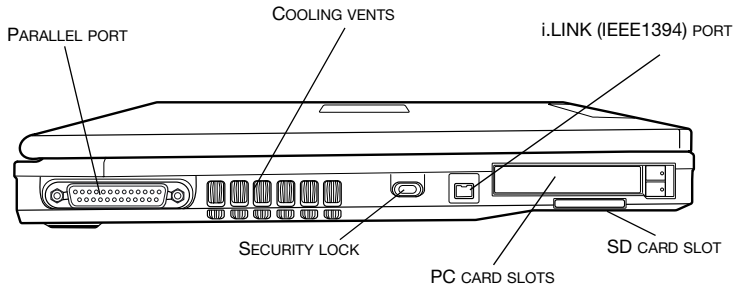

The left side of the computer



Parallel port

This Centronics-compatible, 25-pin parallel port is used to connect a parallel printer or other parallel device. This port supports Extended Capabilities Port (ECP) standard.

Cooling vents

Cooling vents help CPU keep from overheating.



Do not to block the cooling vents. Also do not to keep foreign objects out of them. A pin or similar object can damage the computer's circuitry.



i.LINK (IEEE1394) port

Connect an external device, such as a digital video camera to this port for high-speed data transfer. Some models are equipped with a i.Link port.



SD card slot

SD cards are used in a wide variety of external devices. This slot lets you transfer data from the device to your computer. An indicator on the front side of the slot glows when a card is being accessed.



Keep foreign objects out of the SD card slot. A pin or similar object can damage the computer's circuitry.

**PC card slot**

A PC card slot can accommodate two 5 mm Type II cards or one Type III card. The slot supports 16-bit PC cards and CardBus PC cards.



Keep foreign objects out of the PC card slot. A pin or similar object can damage the computer's circuitry.

**Security lock**

A security cable attaches to this slot. The optional security cable anchors your computer to a desk or other large object to deter theft.

Right side

The figure below shows the computer's right side.

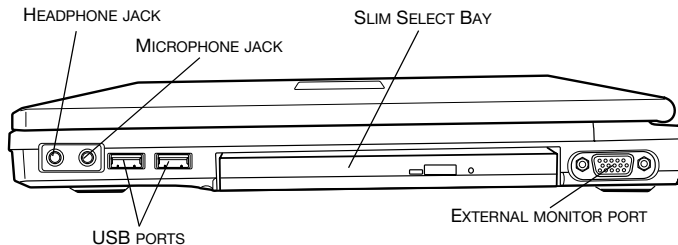

The right side of the computer

**Microphone jack**

A 3.5 mm mini microphone jack enables connection of a three-conductor mini jack for monaural microphone input.

**Headphone jack**

This jack outputs analog audio signals.

Slim Select Bay

A DVD-ROM drive, CD-RW/DVD-ROM drive, DVD Multi drive, DVD±R/±RW drive, Slim Select Bay HDD adaptor or Slim Select Bay 2nd battery pack can be installed in the Slim Select Bay.



External monitor port This 15-pin port lets you connect an external video display.



Universal Serial Bus (USB 2.0) ports The ports comply with the USB 2.0 standard, which enables data transfer speeds 40 times faster than the USB 1.1 standard (The ports also support USB 1.1.).



Keep foreign objects out of the USB connectors. A pin or similar object can damage the computer's circuitry.



Operation of all functions of all USB devices has not been confirmed. Some functions might not execute properly.

Backside

The figure below shows the computer's back panel.

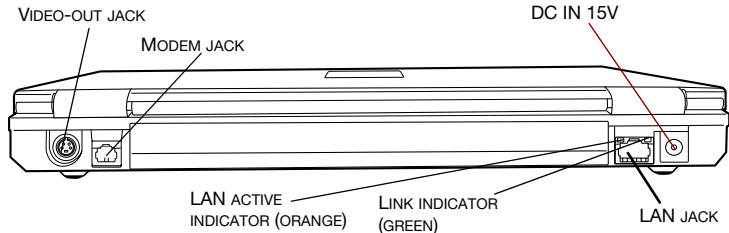

The backside of the computer



Video-out jack

Plug an S-Video cable into this jack for video-out. The S-Video cable carries video signal.



Modem jack

In areas where an internal modem is installed as standard equipment, there is a modem jack that lets you use a modular cable to connect the modem directly to a telephone line.



- *In case of a lightning storm, unplug the modem cable from the telephone jack.*
- *Do not connect the modem to a digital telephone line. A digital line will damage the modem.*

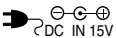

DC IN 15V

The AC adaptor connects to this socket. Use only the model of AC adaptor that comes with the computer. Using the wrong adaptor can damage your computer.



LAN jack

This jack lets you connect to a LAN. The adaptor has built-in support for Ethernet LAN (10 megabits per second, 10BASE-T), Fast Ethernet LAN (100 megabits per second, 100BASE-Tx) and Gigabit Ethernet LAN (1000 megabits per second, 1000BASE-T). The LAN has two indicators. See Chapter 4, *Operating Basics*, for details.

Link indicator (green)

This indicator glows green when the computer is connected to a LAN and the LAN is functioning properly.

LAN active indicator (orange)

This indicator glows orange when data is being exchanged between the computer and the LAN.

Underside

The figure below shows the underside of the computer. Make sure the display is closed before turning over your computer.

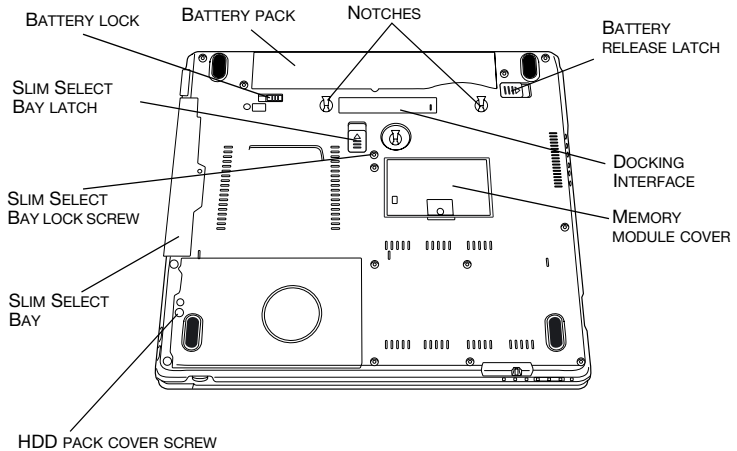

The underside of the computer



Battery lock

Slide this lock to release the battery pack for removal.

Battery pack

The battery pack powers the computer when the AC adaptor is not connected. For detailed information on the battery pack, refer to Chapter 6, *Power and Power-Up Modes*.

Notches

Notches on the computer engage hooks on the Advanced port Replicator III to hold the connection securely.

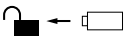

Battery release latch

Slide this latch to release the battery pack for removal.

For detailed information on removing the battery packs, refer to Chapter 6, *Power and Power-Up Modes*.



Docking interface

This port enables connection of an optional Advanced port Replicator III described in Chapter 8 *Optional Devices*.



Keep foreign objects out of the docking interface port. A pin or similar object can damage the computer's circuitry. A plastic shutter protects the connector.



Memory module cover

This cover protects one of the memory module sockets. One or no module is preinstalled. Another memory module is under the keyboard. Refer to the *Memory expansion* section in Chapter 8, *Optional Devices*.



Slim Select Bay lock

Slide the lock to release or secure the Slim Select Bay ejector.



Be sure to lock the Slim Select Bay lock before you transport or carry the computer.



HDD pack cover screw

One screw secures the HDD cover.



Slim Select Bay

See the *Right side* section in this chapter for details.



Slim Select Bay lock screw

One screw secures the Slim Select Bay lock.

Front with the display open

This section shows the computer with the display open. Refer to the appropriate illustration for details.

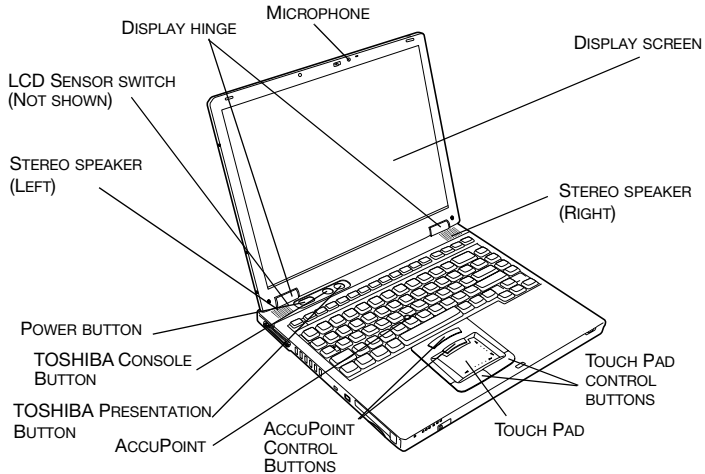

The front of the computer with the display open

The figure above shows the front of the computer with the display open. To open the display, push the display latch on the front of the display and lift up. Position the display at a comfortable viewing angle.

Display hinge	The display hinge holds the display screen at easy-to-view angles.
Microphone	A built-in microphone lets you record sound into your applications. Refer to the <i>Using the microphone</i> section in Chapter 4, Operating Basics.
Display screen	<p>The LCD displays high-contrast text and graphics. The computer's LCD consists of up to 1024 x 768 pixels or 1400 x 1050 pixels. Refer to <i>Display Controller and Modes</i> section in Appendix C.</p> <p>When the computer operates on the AC adaptor the display screen's image will be somewhat brighter than when it operates on battery power. The lower brightness level is intended to save battery power.</p>
Stereo speakers	The speakers emit sound generated by your software as well as audio alarms, such as low battery condition, generated by the system.

Touch pad control buttons Control buttons below the Touch Pad let you select menu items or manipulate text and graphics designated by the on-screen pointer.

Touch pad A Touch pad located in the center of the palm rest is used to control the on-screen pointer. Refer to the *Using the Touch pad* section in Chapter 4, Operating Basics.

AccuPoint control buttons Control buttons below the keyboard let you select menu items or manipulate text and graphics designated by the on-screen pointer.

AccuPoint A pointer control device located in the center of the keyboard is used to control the on-screen pointer. Refer to the *Using the AccuPoint* section in Chapter 4, Operating Basics.



TOSHIBA Presentation button Press this button to change internal display, simultaneous display, or multi-monitor display. The default setting is the simultaneous display on LCD and CRT with resolution of 1024 X 768. When you press this button twice, the display mode returns to single display on LCD only. Setting of multi-monitor display in Windows XP, PC changes its display mode to the multi-monitor display on LCD and CRT. You can also return to single display by pressing this button twice.

The setting of TOSHIBA Presentation button can be changed through the property of TOSHIBA Console. Display mode is changed to the multi-monitor display by selecting "Different Image" (Windows XP only) or to the simultaneous display on internal and external display by selecting "Same Image".



TOSHIBA Console button Press this button to launch an application automatically. The default is TOSHIBA Console.

**Power button**

Press the power button to turn the computer's power on and off.

LCD Sensor switch

This switch senses when the LCD panel is closed or opened and activates the Panel Power Off/On feature. When you close the panel the computer enters Hibernation mode and shuts down. When you open the panel the computer starts in Hibernation mode. Use the TOSHIBA Power Saver Utility to enable or disable this feature. The default is "enabled". Refer to the TOSHIBA Power Saver Utility and Panel Power Off/On items in Chapter 1, *Introduction*, for details on settings.



Do not put a magnetic object close to the switch. The computer will automatically enter Hibernation mode and shut down even if the Panel Power Off features is disabled.

System indicators

LEDs next to icons light when various computer operations are in progress.



SD card

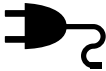

DC IN 15V



Power

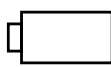

Battery



Disk

Slim Select
BayWireless com-
munication

System indicators



SD card

The **SD card** indicator glows blue when the computer is accessing the SD card slot.



DC IN 15V

The **DC IN 15V** indicator glows in green when DC power is supplied from the AC power adaptor. If the adaptor's output voltage is abnormal or if the power supply malfunctions, this indicator flashes orange.



Power

The **Power** indicator glows in green when the computer is on. If you select **Standby** from **Shut Down Windows**, this indicator flashes orange (one second on, two seconds off) while the computer shuts down.



Battery

The **Battery** indicator shows the condition of the battery's charge: Green indicates full charge, orange indicates battery charging and flashing orange indicates a low battery charge. Refer to Chapter 6, *Power and Power-Up Modes*.



Disk

The **Disk** indicator glows green when the computer is accessing the built-in hard disk.



Slim Select Bay

The **Slim Select Bay** indicator glows in green when the computer is accessing a DVD-ROM drive, CD-RW/DVD-ROM drive, DVD Multi drive and DVD±R/±RW drive or Slim Select Bay HDD adaptor in the Slim Select Bay. When the secondary battery is in the Slim Select Bay, the Slim Select Bay indicator glows as follows:

green : fully charged

orange : charging the battery



Wireless communication

The **Wireless communication** indicator glows when the Bluetooth and wireless LAN functions are turned on.

Some models are equipped with a Wireless communication indicator.

Keyboard indicators

The figures below show the positions of the keypad overlay indicators and the Caps Lock indicator.

When the F10 key indicator glows the keypad overlay lets you control the cursor.

When the F11 key indicator glows the keypad overlay lets you enter numbers.

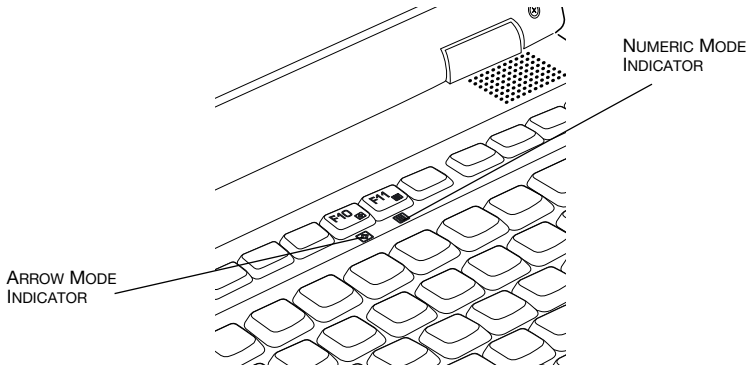

Keypad overlay indicators

When the Caps Lock indicator glows the keyboard is in all-caps mode.

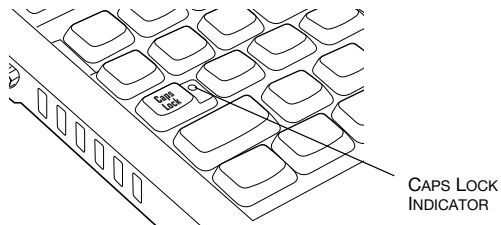

Caps Lock indicator

**Caps Lock**

This indicator glows green when the alphabet keys are locked in uppercase.

Arrow mode

When the **Arrow mode** indicator lights green, you can use the keypad overlay (gray labeled keys) as cursor keys. Refer to the *Keypad overlay* section in Chapter 5, The Keyboard.

**Numeric mode**

You can use the keypad overlay (gray labeled keys) for numeric input when the **Numeric mode** indicator lights green. Refer to the *Keypad overlay* section in Chapter 5, The Keyboard.

USB floppy disk drive (optional)

An optional external 3 1/2" floppy disk drive accommodates 1.44-megabyte or 720-kilobyte diskettes. It connects to the USB port.

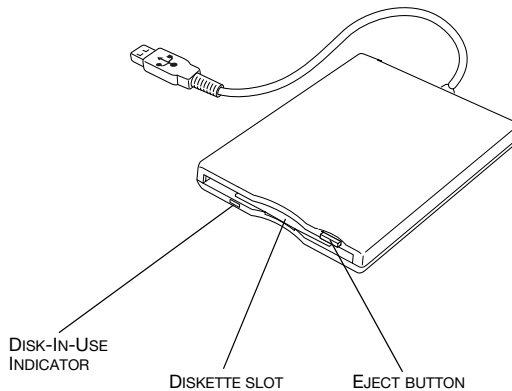

USB floppy disk drive

Disk-In-Use Indicator

This indicator lights when the diskette is being accessed.

Diskette slot

Insert a diskette in this slot.

Eject button

When a diskette is fully seated in the drive, the eject button pops out. To remove a diskette, push in the eject button and the diskette pops out partially for removal.



Check the **Disk-In-Use** indicator when you use the floppy disk drive. Do not press the eject button or turn off the computer while the light is glowing. Doing so could destroy data and damage the diskette or the drive.



- *The external floppy disk drive should be placed on a flat, horizontal surface when in use. Do not set the drive on an incline greater than 20° while it is operating.*
- *Do not set anything on top of the floppy disk drive.*

Optical media drives

One of the following optical media drives is installed in the computer: DVD-ROM, CD-RW/DVD-ROM, DVD Multi and DVD±R/±RW drives. An ATAPI interface controller is used for CD/DVD-ROM operation. When the computer is accessing a CD/DVD, an indicator on the drive glows.

Region codes for DVD drives and media

DVD-ROM, CD-RW/DVD-ROM, DVD Multi, DVD±R/±RW drives and media are manufactured according to the specifications of six marketing regions. When you purchase DVD-Video, make sure it matches your drive, otherwise it will not play properly.

Code	Region
1	Canada, United States
2	Japan, Europe, South Africa, Middle East
3	Southeast Asia, East Asia
4	Australia, New Zealand, Pacific Islands, Central America, South America, Caribbean
5	Russia, Indian Subcontinent, Africa, North Korea, Mongolia
6	China

Writable discs

This section describes the types of writable CD/DVD discs. Check the specifications for your drive to for the type of discs it can write. Use Drag'n Drop CD+DVD to write compact discs. Refer to Chapter 4, *Operating Basics*.

CDs

- CD-R discs can be written only once. The recorded data cannot be erased or changed.
- CD-RW discs can be recorded more than once. Use either 1, 2, or 4 multi speed CD-RW discs or high-speed 4- to 10-speed discs. The write speed of the ultra-speed CD-RW discs (Ultra-speed is CD-RW/DVD-ROM drive only) is maximum 24-speed.

DVDs

- DVD-R discs can be written only once. The recorded data cannot be erased or changed.
- DVD-RW discs can be recorded more than once.
- DVD-RAM discs can be recorded more than once.

Formats

The drives support the following formats:

- DVD-ROM
- DVD -Video
- CD-DA
- CD-Text
- Photo CD™ (single/multi-session)
- CD-ROM Mode 1, Mode 2
- CD-ROM XA Mode 2 (Form1, Form2)
- Enhanced CD (CD-EXTRA)
- CD-G (Audio CD only)
- Addressing Method 2

DVD-ROM drive

The full-size DVD-ROM drive module lets you record data to rewritable CDs as well as run either 12 cm (4.72") or 8 cm (3.15") CD/DVDs without using an adaptor.



The read speed is slower at the center of a disc and faster at the outer edge.

DVD read	8 speed (maximum)
CD read	24 speed (maximum)

CD-RW/DVD-ROM drive

The full-size CD-RW/DVD-ROM drive module lets you record data to rewritable CDs as well as run either 12 cm (4.72") or 8 cm (3.15") CD/DVDs without using an adaptor.



The read speed is slower at the center of a disc and faster at the outer edge.

DVD read	8 speed (maximum)
CD read	24 speed (maximum)
CD-R write	24 speed (maximum)
CD-RW write	24 speed (maximum, high-speed media)

DVD Multi drive

The full-size DVD Multi drive module lets you record data to rewritable CD/DVDs as well as run either 12 cm (4.72") or 8 cm (3.15") CD/DVDs without using an adaptor.



The read speed is slower at the center of a disc and faster at the outer edge.

DVD read	8 speed (maximum)
DVD-R write	2 speed
DVD-RW write	1 speed
DVD-RAM write	2 speed
CD read	24 speed (maximum)
CD-R write	16 speed (maximum)
CD-RW write	8 speed (maximum, high-speed media)

DVD±R/±RW drive (DVD Dual drive)

The full-size DVD±R/±RW drive module lets you record data to rewritable CD/DVDs as well as run either 12 cm (4.72") or 8 cm (3.15") CD/DVDs without using an adaptor.



The read speed is slower at the center of a disc and faster at the outer edge.

DVD read	8 speed (maximum)
DVD-R write	2 speed (maximum)
DVD-RW write	2 speed (maximum)
DVD+R write	2.4 speed (maximum)
DVD+RW write	2.4 speed (maximum)
CD read	24 speed (maximum)
CD-R write	16 speed (maximum)
CD-RW write	10 speed (maximum, high-speed media)

AC adaptor

The AC adaptor converts AC power to DC power and reduces the voltage supplied to the computer. It can automatically adjust to any voltage from 100 to 240 volts and to a frequency of either 50 or 60 hertz, enabling you to use the computer in almost any country/region.

To recharge the battery, simply connect the AC adaptor to a power source and the computer. See Chapter 6, *Power and Power-Up Modes*, for details.

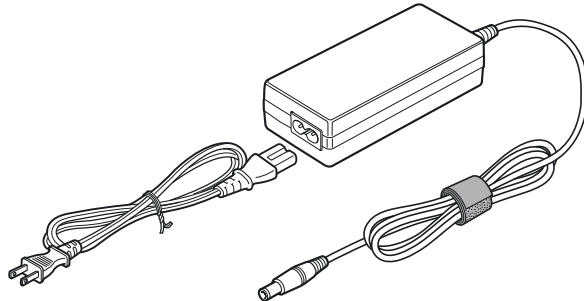

The AC adaptor



Use only the AC adaptor that came with the computer or an equivalent optional adaptor. Use of the wrong adaptor could damage your computer. TOSHIBA assumes no liability for any damage in such case.



Use only the AC adaptor supplied as an accessory. Other AC adaptors have different voltage and terminal polarities and use of them may produce heat and smoke or even result in fire or rupture.

Chapter 3

Getting Started

This chapter provides basic information to get you started using your computer. It covers the following topics:

- Setting up your work space — for your health and safety



Be sure also to read the Safety Instruction Manual. This guide, which is included with the computer, explains product liability.

- Connecting the AC adaptor
- Opening the display
- Turning on the power
- Windows XP setup
- Turning off the power
- Restarting the computer
- Restoring the preinstalled software



All users should be sure to read the section Windows XP setup.

Setting up your work space

Establishing a comfortable work site is important for you and your computer. A poor work environment or stressful work habits can result in discomfort or serious injury from repetitive strain to your hands, wrists or other joints. Proper ambient conditions should also be maintained for the computer's operation. This section discusses the following topics:

- General conditions
- Placement of the computer
- Seating and posture
- Lighting
- Work habits

General conditions

In general, if you are comfortable, so is your computer, but read the following to make sure your work site provides a proper environment.

- Make sure there is adequate space around the computer for proper ventilation.
- Make sure the AC power cord connects to an outlet that is close to the computer and easily accessible.
- The temperature should be 5 to 35 degrees Centigrade (41 to 95 degrees Fahrenheit) and the relative humidity should be 20 to 80 percent.
- Avoid areas where rapid or extreme changes in temperature or humidity may occur.
- Keep the computer free of dust, moisture, and exposure to direct sunlight.
- Keep the computer away from heat sources, such as electric heaters.
- Do not use the computer near liquids or corrosive chemicals.
- Do not place the computer near objects that create strong magnetic fields (e.g., stereo speakers).
- Some computers in the computer, including data storage media, can be damaged by magnets. Do not place the computer near magnetic objects or bring magnetic objects close to the computer. Be careful of objects, such as stereo speakers, that produce strong magnetic fields during operation. Also, be careful with metal objects, such as bracelets, which can be inadvertently magnetized.
- Do not operate the computer in close proximity to a mobile phone.
- Leave ample ventilation room for the fan. Do not block the vents.

Placement of the computer

Position the computer and peripheral devices to provide comfort and safety.

- Set the computer on a flat surface at a comfortable height and distance. The display should be no higher than eye level to avoid eyestrain.
- Place the computer so that it is directly in front of you when you work and make sure you have adequate space to easily operate other devices.
- Allow adequate space behind the computer to let you freely adjust the display. The display should be angled to reduce glare and maximize visibility.
- If you use a paper holder, set it at about the same height and distance as the computer.

Seating and posture

The height of your chair in relation to the computer and keyboard as well as the support it gives your body are primary factors in reducing work strain. Refer to the following tips and to figure below.

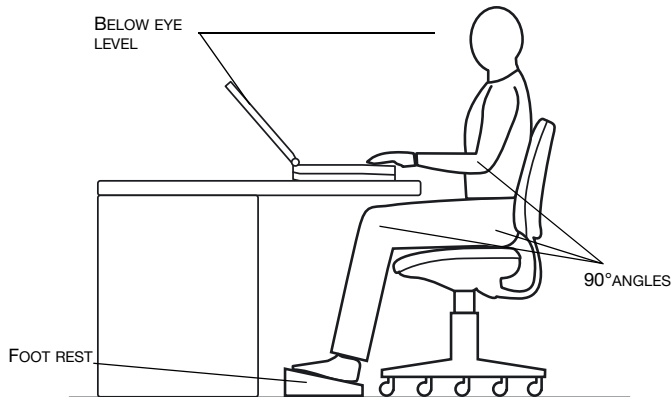

Posture and positioning of the computer

- Place your chair so that the keyboard is at or slightly below the level of your elbow. You should be able to type comfortably with your shoulders relaxed.
- Your knees should be slightly higher than your hips. If necessary, use a foot rest to raise the level of your knees to ease pressure on the back of your thighs.
- Adjust the back of your chair so it supports the lower curve of your spine.
- Sit straight so that your knees, hips and elbows form approximately 90 degree angles when you work. Do not slump forward or lean back too far.

Lighting

Proper lighting can improve legibility of the display and reduce eyestrain.

- Position the computer so that sunlight or bright indoor lighting does not reflect off the screen. Use tinted windows, shades or other screen to eliminate sun glare.
- Avoid placing the computer in front of bright light that could shine directly in your eyes.
- If possible, use soft, indirect lighting in your computer work area. Use a lamp to illuminate your documents or desk, but be sure to position the lamp so that it does not reflect off the display or shine in your eyes.

Work habits

A key to avoiding discomfort or injury from repetitive strain is to vary your activities. If possible, schedule a variety of tasks into your workday. If you must spend long periods at the computer, finding ways to break up the routine can reduce stress and improve your efficiency.

- Sit in a relaxed posture. Good positioning of your chair and equipment as described earlier can reduce tension in your shoulders or neck and ease back strain.
- Vary your posture frequently.
- Occasionally stand up and stretch or exercise briefly.
- Exercise and stretch your wrists and hands a number of times during the day.
- Frequently, look away from the computer and focus your eyes on a distant object for several seconds, for example 30 seconds every 15 minutes.
- Take frequent short breaks instead of one or two long breaks, for example, two or three minutes every half hour.
- Have your eyes examined regularly and visit a doctor promptly, if you suspect you might be suffering from a repetitive strain injury.

A number of books are available on ergonomics and repetitive strain injury or repetitive stress syndrome. For more information on these topics or for pointers on exercises for such stress points as hands and wrists, please check with your library or book vendor. Also refer to the computer's *Safety Instruction Manual*.

Connecting the AC adaptor

Attach the AC adaptor when you need to charge the battery or you want to operate from AC power. It is also the fastest way to get started, because the battery pack will need to be charged before you can operate from battery power.

The AC adaptor can be connected to any power source supplying from 100 to 240 volts and 50 or 60 hertz. For details on using the AC adaptor to charge the battery pack, refer to Chapter 6, *Power and Power-Up Modes*.



Use only the AC adaptor supplied as an accessory. Other AC adaptors have different voltage and terminal polarities and use of them may produce heat and smoke or even result in fire or rupture.



- Use only the AC adaptor supplied with your computer or an equivalent adaptor that is compatible. Use of any incompatible adaptor could damage your computer. TOSHIBA assumes no liability for any damage caused by use of an incompatible adaptor.
- When you connect the AC adaptor to the computer, always follow the steps in the exact order as described in the User's Manual. Connecting the power cable to a live electrical outlet should be the last step otherwise the adaptor DC output plug could hold an electrical charge and cause an electrical shock or minor bodily injury when touched. As a general safety precaution, avoid touching any metal parts.

1. Connect the power cord to the AC adaptor.

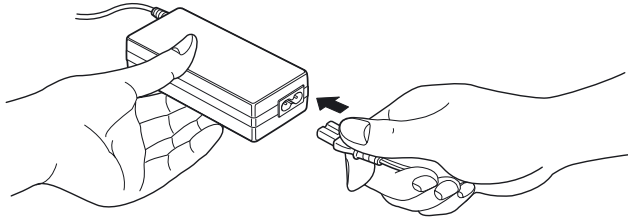

Connecting the power cord to the AC adaptor

2. Connect the AC adaptor's DC output plug to the **DC IN 15V** input port on the back of the computer.

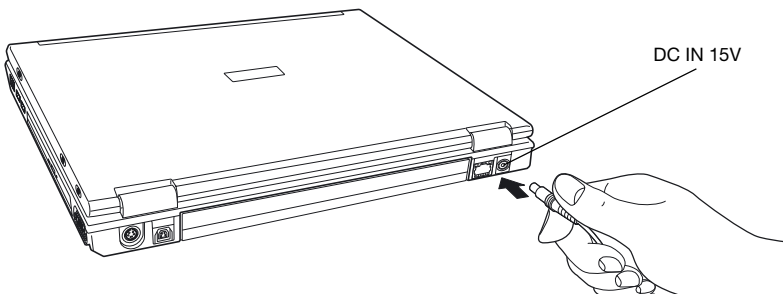

Connecting the adaptor to the computer

3. Plug the power cord into a live wall outlet. The **Battery** and **DC IN 15V** indicators on the front of the computer should glow.

Opening the display

The display panel can be rotated in a wide range of angles for optimal viewing.

1. Slide the display latch on the front of the computer to the right.
2. Lift the panel up and adjust it to the best viewing angle for you.



Use reasonable care when opening and closing the display panel. Opening it vigorously or slamming it shut could damage the computer.

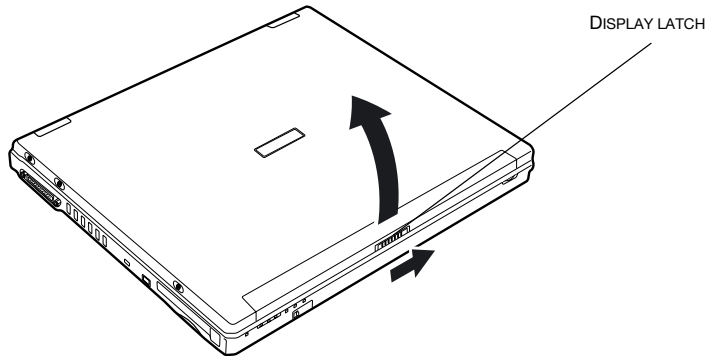

Opening the display

Turning on the power

This section describes how to turn on the power.



After you turn on the power for the first time, do not turn it off until you have set up the operating system. Refer to the section *Windows XP setup*.

1. If an external floppy disk drive is connected, make sure it is empty. If a diskette is in the drive, press the eject button and remove the diskette.
2. Open the display.
3. Press and hold the computer's power button for two or three seconds.

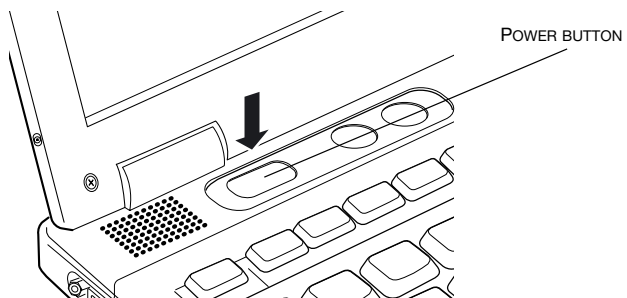

Turning on the power

Windows XP setup

When you first turn on the power, the computer's initial screen is the Microsoft Windows XP Professional Startup Screen Logo.

Follow the on-screen directions.

Turning off the power

The power can be turned off in one of the following modes: Shut down (Boot), Hibernation or Standby mode.

Shut Down mode (Boot mode)

When you turn off the power in Shut Down mode no data is saved and the computer will boot to the operating system's main screen.

1. If you have entered data, save it to the hard disk or to a diskette.
2. Make sure all disk (disc) activity has stopped, then remove the CD/DVDS or diskette.



*Make sure the **Disk**, **Slim Select Bay** and **Slim Select Bay's** module indicators are off. If you turn off the power while a disk (disc) is being accessed, you can lose data or damage the disk (disc).*

3. Click **start** then click **Turn Off Computer**. From the **Turn Off Computer** menu select **Turn Off**.
4. Turn off the power to any peripheral devices.



Do not turn the computer or devices back on immediately. Wait a moment to let all capacitors fully discharge.

Hibernation mode

The hibernation feature saves the contents of memory to the hard disk when the computer is turned off. The next time the computer is turned on, the previous state is restored. The hibernation feature does not save the status of peripheral devices.



- *Save your data. While entering hibernation mode, the computer saves the contents of memory to the HDD. However, for safety sake, it is best to save your data manually.*
- *Data will be lost if you remove the battery or disconnect the AC adaptor before the save is completed. Wait for the **Disk** indicator to go out.*
- *Do not install or remove a memory module while the computer is in hibernation mode. Data will be lost.*

Benefits of hibernation

The hibernation feature provides the following benefits:

- Saves data to the hard disk when the computer automatically shuts down because of a low battery.



For the computer to shut down in hibernation mode, the hibernation feature must be enabled in two places : the **Hibernate** tab in **Power Options** and **Setup Action** tab in **TOSHIBA Power Saver**.

Otherwise, the computer will shut down in **Standby** mode. If battery power becomes depleted, data saved in **Standby** mode will be lost.

- You can return to your previous working environment immediately when you turn on the computer.
- Saves power by shutting down the system when the computer receives no input or hardware access for the duration set by the System hibernate feature.
- You can use the panel power off feature.

Starting Hibernation



You can also enable Hibernation by pressing **Fn + F4**. See Chapter 5, The Keyboard, for details.

To enter Hibernation mode, follow the steps below.

1. Click **start**.
2. Select **Turn Off Computer**.
3. Open the **Turn Off Computer** dialog box. **Hibernate** is not displayed.
4. Press the **Shift** key. The **Standby** item will change to **Hibernate**.
5. Select the **Hibernate**.

Automatic Hibernation

The computer will enter Hibernate mode automatically when you press the power button or close the lid. First, however, make the appropriate settings according to the steps below.

1. Open the **Control Panel**.
2. Open **Performance and Maintenance** and open **Power Options**.
3. Select the **Hibernate** window in the **Power Options Properties**, select the **Enable hibernation** check box and click the **Apply** button.
4. Open **TOSHIBA Power Saver**.
5. Select the **Setup Action** window.
6. Enable the desired Hibernation settings for **When I press the power button** and **When I close the lid**.
7. Click the **OK** button.

Data save in hibernation mode

When you turn off the power in hibernation mode, the computer takes a moment to save current memory data to the hard disk. During this time, the **Disk** indicator will light.

After you turn off the computer and memory is saved to the hard disk, turn off the power to any peripheral devices.



Do not turn the computer or devices back on immediately. Wait a moment to let all capacitors fully discharge.

Standby mode

If you have to interrupt your work, you can turn off the power without exiting from your software. Data is maintained in the computer's main memory. When you turn on the power again, you can continue working right where you left off.



- *When the AC adaptor is connected, the computer will go into Standby mode according to the settings in the TOSHIBA Power Saver utility.*
- *To restore operation from Standby mode, press the power button or press any key. The latter action works only if Wake-up on Keyboard is enabled in HW Setup.*
- *If the computer automatically enters Standby mode while a network application is active, the application might not be restored when the computer wakes up from Standby.*
- *To prevent the computer from automatically entering Standby mode, disable Standby in TOSHIBA Power Saver. That action, however, will nullify the computer's Energy Star compliance.*



- *Before entering Standby mode, be sure to save your data.*
- *Do not install or remove a memory module while the computer is in standby mode. The computer or the module could be damaged.*
- *Do not remove the battery pack while the computer is in standby mode (unless the computer is connected to an AC power source). Data in memory will be lost.*
- *If you carry the computer on board an aircraft or into a hospital, be sure to shut down the computer in hibernation mode or in shutdown mode to avoid radio signal interference.*

Benefits of standby

The standby feature provides the following benefits:

- Restores the previous working environment more rapidly than does hibernation.
- Saves power by shutting down the system when the computer receives no input or hardware access for the duration set by the System Standby feature.
- You can use the panel power off feature.

Executing standby



You can also enable Standby by pressing **Fn + F3**. See Chapter 5, The Keyboard, for details.

You can enter standby mode in one of three ways:

1. Click **Start**, click **Turn Off Computer** and click **Stand by**.
2. Close the display panel. This feature must be enabled. Refer to the *Setup Action* tab in *TOSHIBA Power Saver Utility* described in the Control Panel.
Open **Performance and Maintenance** and open **TOSHIBA Power Saver**.
3. Slide the power button. This feature must be enabled. Refer to the *Setup Action* tab in *TOSHIBA Power Saver Utility* described in the Control Panel.

When you turn the power back on, you can continue where you left when you shut down the computer.



- *When the computer is shut down in standby mode, the power indicator flashes orange.*
- *If you are operating the computer on battery power, you can lengthen the operating time by shutting down in hibernation mode. Standby mode consumes more power.*

Standby limitations

Standby will not function under the following conditions:

- Power is turned back on immediately after shutting down.
- Memory circuits are exposed to static electricity or electrical noise.

Restarting the computer

Certain conditions require that you reset the system. For example, if:

- You change certain computer settings.
- An error occurs and the computer does not respond to your keyboard commands.
- There are three ways to reset the computer system:
 1. Press **Ctrl + Alt + Del** to display the **Windows Task Manager**, then select **Shutdown** and **Restart**.
 2. Select **Restart** from the **Turn Off Computer** window in the **start** menu.
 3. Press the power button and hold it down for five seconds. Wait 10 to 15 seconds, then turn the power on again by pressing the power button.

Restoring the preinstalled software

If preinstalled files are damaged, use the Product Recovery disk or the TOSHIBA Tools & Utilities CD-ROM to restore them.

Restoring the complete system

To restore the operating system and all preinstalled software, follow the steps below.



When you reinstall the Windows operating system, the hard disk will be reformatted and all data will be lost. Make sure you have a backup copy of your data, before you perform a complete system recovery.

1. Load the Product Recovery disk in the optical media drive and turn off the computer's power.
2. Hold down the **F12** key and turn on the power. When **In Touch with Tomorrow TOSHIBA** appears, release the **F12** key.
3. Use the left or right cursor key to select the DVD-ROM icon in the displayed menu. For details, refer to the *Boot Priority* section in Chapter 7, HW Setup.
4. Follow the on-screen instructions.
5. If your computer came with additional software installed, this software can not be recovered from the Product Recovery disk. Re-install these applications (e.g. Works Suite, DVD Player, Games, etc.) separately from other media.

Restoring TOSHIBA utilities and drivers

If Windows is working properly, individual drivers or applications can be separately restored. Use the Tools & Utilities CD-ROM according to instructions in the booklet contained in the CD box to reinstall TOSHIBA utilities and drivers.

Chapter 4

Operating Basics

This chapter gives information on basic operations including using the TOSHIBA Dual Pointing Devices, USB floppy disk drive, the sound system, the optical media drives, the internal modem, wireless communication, LAN, and changing Slim Select Bay modules. It also provides tips on caring for your computer, diskettes and CD/DVDs.

TOSHIBA Dual Pointing Device

The computer is equipped with a dual point system: a Touch pad and an AccuPOINT pointing stick.

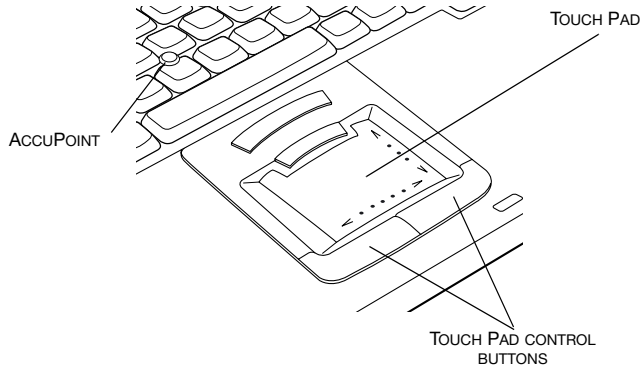

Touch pad and Touch pad control buttons

Using the Touch pad

To use the Touch pad, simply touch and move your fingertip across it in the direction you want the on-screen pointer to go.

Two buttons below the Touch pad are used like the buttons on a mouse pointer. Press the left button to select a menu item or to manipulate text or graphics designated by the pointer. Press the right button to display a menu or other function depending on the software you are using.



You can also tap the Touch pad to perform functions similar to those of the left button.

Click: Tap the Touch pad once

Double-click: Tap twice

Drag and drop: Tap to select the material you want to move. Leave your finger on the Touch pad after the second tap and move the material.

Using the AccuPoint

To use the AccuPoint, simply push it with your finger tip in the direction you want to move the on-screen pointer.

Two buttons above the Touch pad work in the same way with the AccuPoint as they do with the Touch pad. Refer to the *Using the Touch pad* section for details.

AccuPoint precautions

Certain conditions can affect the on-screen pointer when using AccuPoint. For example, the pointer may travel contrary to AccuPoint operation or an error message may appear, if

- You touch the AccuPoint during power-up.
- You apply constant, soft pressure during power-up.
- There is a sudden temperature change.
- Strong stress is applied to the AccuPoint.

If an error message appears, reboot the computer. If an error message does not appear, wait a moment for the pointer to stop, then continue operation.

Replacing the cap

The AccuPoint cap is an expendable item that should be replaced after prolonged use.

1. To remove the AccuPoint cap, firmly pinch the cap and pull it straight up.



Removing the AccuPoint cap

2. Position a new cap on the peg and press it into place.



The peg is square, so be careful to align the cap's square hole with the peg.

Using the USB floppy disk drive (optional)

An optional 3 1/2" floppy disk drive connects to the computer's USB port. It accommodates 1.44-megabyte or 720-kilobyte diskettes. Refer to Chapter 2, *The Grand Tour*, for more information.

Connecting 3 1/2" floppy disk drive

To connect the drive, plug the floppy disk drive connector into a USB port. Refer to figure below.



Make sure the connector is right side up and properly aligned with the socket. Do not try to force the connection; doing so can damage the connecting pins.

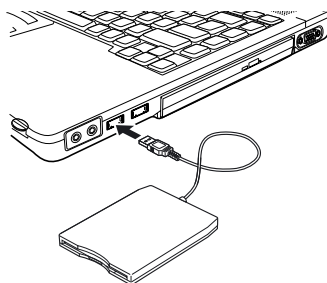

Connecting the USB floppy disk drive



If you connect the floppy disk drive after turning on the computer, it will take about 10 seconds for the computer to recognize the drive. Do not disconnect and reconnect before 10 seconds has elapsed.

Disconnecting 3 1/2" floppy disk drive

When you have finished using the floppy disk drive, follow the procedures below to disconnect it:

1. Wait for the indicator light to go out to make sure all diskette activity has stopped.



If you disconnect the floppy disk drive or turn off the power while the computer is accessing the drive you may lose data or damage the diskette or the drive.

2. Click the **Safety Remove Hardware** icon on the Task Bar.
3. Click **Floppy disk drive**.
4. Pull the floppy disk drive connector out of the USB port.

Changing Slim Select Bay modules

This section explains how to change modules in the Slim Select Bay. The illustrations show replacement of the DVD-ROM drive with the Slim Select Bay HDD adaptor. Therefore, the text refers to those modules. However, the procedures are the same for any of the modules: DVD-ROM drive, CD-RW/DVD-ROM drive, DVD Multi drive, DVD±R/±RW drive, HDD adaptor, or Slim Select Bay 2nd battery pack with separate tray.



- *To avoid injury, do not put your hand into the Slim Select Bay slot.*
- *Before removing or inserting a second battery pack, turn off the computer's power.*



The TOSHIBA Mobile Extension is preinstalled to support hot swapping under Windows. Refer to Chapter 1, Introduction for information on using this utility to change modules while the computer's power is on.

Removing a module

Remove the DVD-ROM drive as described below.

1. Check all disk indicators to make sure no disks are operating.
2. Turn the computer upside down.



Wait for all disk indicators to go out before you turn over the computer and do not lay the computer down gently. Shock can damage the HDD or other components.

3. Remove the screw near the icon securing the Slim Select Bay.

4. Make sure the screw in the Slim Select Bay lock is set in the hole for the unlock position.
5. Slide the Slim Select Bay latch to the unlock position.
6. Grasp the DVD-ROM drive and slide it out.



The DVD-ROM drive and other Slim Select Bay modules can become hot with use. Be careful when removing the module.

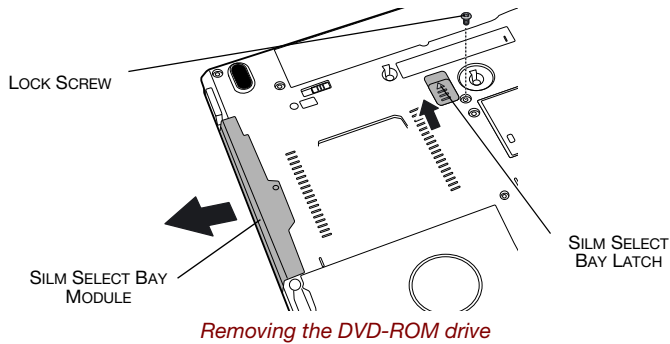

Inserting a module

Insert the Slim Select Bay HDD adaptor as described below.

1. Insert the Slim Select Bay HDD adaptor in the computer as shown below and press until the ejector clicks.
2. If you want to lock the Slim Select Bay module, set the Slim Select Bay lock screw in the hole for the lock position. The lock screw is inserted in the unlock position at the time of purchasing.

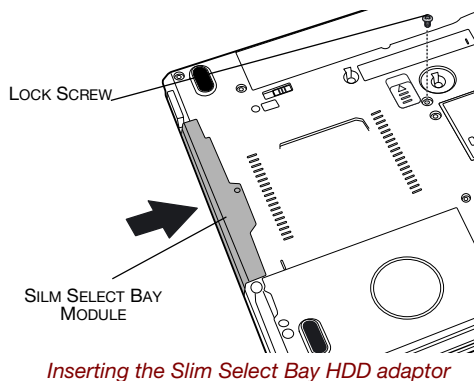

Using optical media drives

The text and illustrations in this section refer primarily to the DVD-ROM drive. However, operation is the same for other optical drive in the Slim Select Bay. The full-size drive provides high-performance execution of CD/DVD-ROM-based programs. You can run either 12 cm (4.72") or 8 cm (3.15") CD/DVDs without an adaptor. An ATAPI interface controller is used for CD/DVD-ROM operation. When the computer is accessing a CD/DVD-ROM, an indicator on the drive glows and the Slim Select Bay indicator glows.



Use the WinDVD 4 application to view DVD-Video discs.

If you have a CD-RW/DVD-ROM drive, refer also to the *Writing CDs on CD-RW/DVD-ROM drive* section for precautions on writing to CDs.

If you have a DVD Multi drive, refer also to the *Writing CD/DVDs on DVD Multi drive* section for precautions on writing to CDs.

If you have a DVD±R/±RW drive, refer also to the *Important message (DVD±R/RW drive)* section for precautions on writing to CDs.

Loading discs

To load CD/DVDs, follow the steps below and refer to next figures.

1. a. When the power is on, press the DVD-ROM eject button to open the drawer slightly.

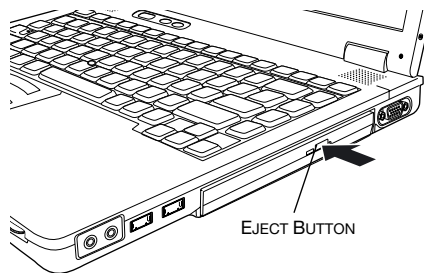

Pressing the DVD-ROM eject button

- b. Pressing the eject button will not open the drawer when the DVD-ROM drive's power is off. If the power is off, you can open the drawer by inserting a slender object (about 15 mm) such as a straightened paper clip into the eject hole just to the right of the eject button.

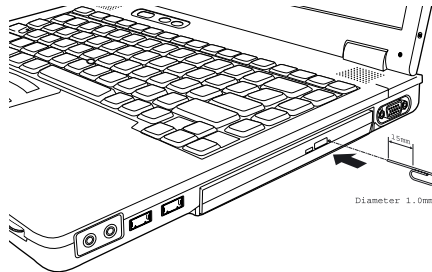

Manual release with the eject hole

2. Pinch the drawer gently and pull until it is fully opened.

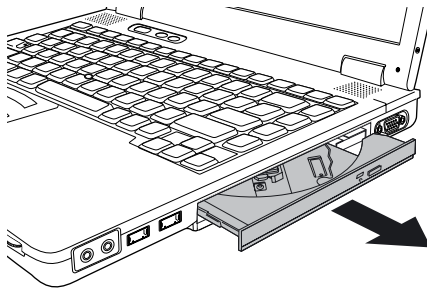

Pulling the drawer open

3. Lay the CD/DVD, label side up, in the drawer.

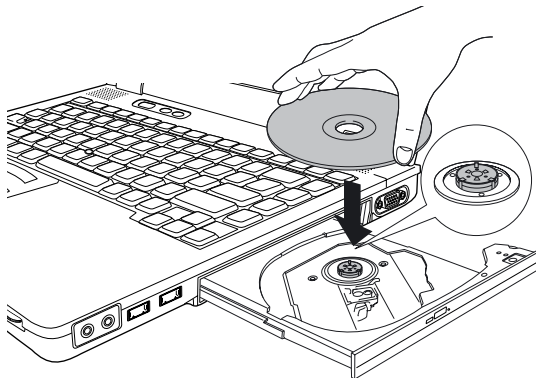

Inserting a CD/DVD



When the drawer is fully opened, the edge of the computer will extend slightly over the CD/DVD tray. Therefore, you will need to turn the CD/DVD at an angle when you place it in the tray. After seating the CD/DVD, however, make sure it lies flat, as shown in figure above.



- Do not touch the laser lens. Doing so could cause misalignment.
- Do not keep foreign matter from entering the drive. Check the back edge of the tray to make sure it carries no debris before closing the drive.

4. Press gently at the center of the CD/DVD until you feel it click into place. The CD/DVD should lie below the top of the spindle, flush with the spindle base.
5. Push the center of the drawer to close it. Press gently until it locks into place.



If the CD/DVD is not seated properly when the drawer is closed, the CD/DVD might be damaged. Also, the drawer might not open fully when you press the eject button.

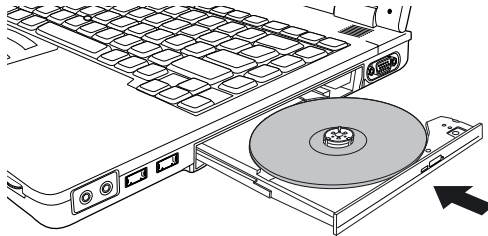

Closing the DVD-ROM drawer

Removing discs

To remove the CD/DVD, follow the steps below and refer to the next figure.



Do not press the eject button while the computer is accessing the DVD-ROM drive. Wait for the Slim Select Bay indicator to go out before you open the drawer. Also, if the CD/DVD is spinning when you open the drawer, wait for it to stop before you remove it.

1. To pop the drawer partially open, press the eject button. Gently pull the drawer out until it is fully opened.



- *When the drawer pops open slightly, wait a moment to make sure the CD/DVD has stopped spinning before pulling the drawer fully open.*
- *Turn off the power before you use the eject hole. If the CD/DVD is spinning when you open the drawer, the CD/DVD could fly off the spindle and cause injury.*

2. The CD/DVD extends slightly over the sides of the drawer so you can hold it. Hold the CD/DVD gently and lift it out.

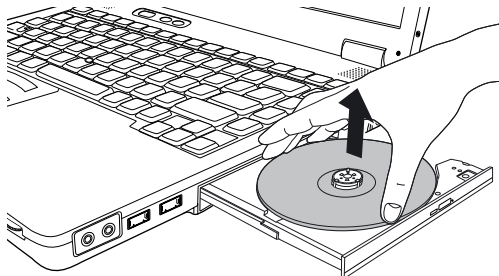

Removing a CD/DVD

3. Push the center of the drawer to close it. Press gently until it locks into place.

Writing CDs on CD-RW/DVD-ROM drive

Depending on the type of drive installed, you may be able to write CDs. The CD-RW/DVD-ROM drive lets you write as well as read CD-ROMs. Observe the precautions in this section to ensure the best performance for writing CDs. For information on loading and unloading CDs refer to the Using optical media drive section.



CD-R discs can be written to only once. CD-RW discs can be rewritten many times.

Before writing or rewriting

Please observe the following points when you write or rewrite the data.

- We recommend the following manufacturers of CD-R and CD-RW media. Media quality can affect write or rewrite success rates.

CD-R: TAIYO YUDEN CO., LTD.
Mitsui Chemicals Inc.
MITSUBISHI CHEMICAL CORPORATION
RICOH Co., Ltd.
Hitachi Maxell Ltd.

CD-RW: MITSUBISHI CHEMICAL CORPORATION
RICOH Co., Ltd.

*The following special media recommend the next manufacturers.

- Multi-Speed and High-Speed CD-ROM:
MITSUBISHI CHEMICAL CORPORATION, RICOH Co., Ltd.
- Ultra-Speed CD-ROM:
MITSUBISHI CHEMICAL CORPORATION

TOSHIBA has confirmed the operation of CD-R and CD-RW media of the manufacturers above. Operation of other media cannot be guaranteed.

- CD-RW can generally be rewritten about 1,000 times. However, the actual number of rewrites is affected by the quality of the media and the way it is used.
- Be sure to connect the AC adaptor when you write or rewrite.
- Be sure to close all other software programs except the writing software.
- Do not run software such as a screen saver which can put a heavy load on the CPU.
- Operate the computer at full power. Do not use power-saving features.
- Do not write while virus check software is running. Wait for it to finish, then disable virus detection programs including any software that checks files automatically in the background.
- Do not use hard disk utilities, including those intended to enhance HDD access speed. They may cause unstable operation and damage data.
- Write from the computer's HDD to the CD. Do not try to write from shared devices such as a LAN server or any other network device.

- Writing with software other than Drag'n Drop CD+DVD has not been confirmed. Therefore, operation with other software cannot be guaranteed.

When writing or rewriting

Note the following when you write or rewrite a CD-R or CD-RW.

- Always copy data from the HDD to the CD. Do not use cut-and-paste. The original data will be lost if there is a write error.
- Do not perform any of the following actions:
 - Change users in the Windows XP operating system.
 - Operate the computer for any other function, including use of a mouse or Touch Pad, closing/opening the LCD panel.
 - Start a communication application such as a modem.
 - Apply impact or vibration to the PC.
 - Install, remove or connect external devices, including the following: PC card, SD card, USB devices, external display, i.LINK devices, optical digital devices.
 - Open the optical media drive.
- If the media is poor in quality, dirty or damaged, writing or rewriting errors may occur.
- Set the computer on a level surface and avoid places subject to vibration such as airplanes trains, or cars. Do not use an unstable surface such as a stand.
- Keep mobile phones and other wireless communication devices away from the computer.

Writing CD/DVDs on DVD Multi drive

You can use the DVD Multi drive to write data to either CD-R/-RW or DVD-R/-RW/-RAM discs. The following applications for writing are supplied on CD-ROM:

Drag'n Drop CD+DVD, licensed by Easy Systems Japan Ltd., and DigiOn Inc., InterVideo WinDVD Creator 2 Platinum, which is a product of InterVideo, Inc.

Writing CD/DVDs on DVD±R/±RW drive (DVD Dual drive)

You can use the DVD±R/±RW drive to write data to either CD-R/RW or DVD-R/-RW/+R/+RW discs. The following applications for writing are supplied on CD-ROM:

Drag'n Drop CD+DVD, licensed by Easy Systems Japan Ltd., and DigiOn Inc., InterVideo WinDVD Creator 2 Platinum, which is a product of InterVideo, Inc.

Important message (DVD Multi drive)

Before you write or rewrite to CD-R/-RW or DVD-R/-RW/-RAM disc, read and follow all setup and operating instructions in this section. If you fail to do so, the DVD Multi drive may not function properly, and you may fail to write or rewrite, lose data or incur other damage.

Important message (DVD±R/RW drive)

Before you write or rewrite to CD-R/RW or DVD-R/-RW/+R/+RW disc, read and follow all setup and operating instructions in this section. If you fail to do so, the DVD±RW drive may not function properly, and you may fail to write or rewrite, lose data or incur other damage.

Disclaimer (DVD Multi drive)

TOSHIBA does not bear responsibility for the following:

- Damage to any CD-R/-RW or DVD-R/-RW/-RAM disc that may be caused by writing or rewriting with this product.
- Any change or loss of the recorded contents of CD-R/-RW or DVD-R/-RW/-RAM disc that may be caused by writing or rewriting with this product, or for any business profit loss or business interruption that may be caused by the change or loss of the recorded contents.
- Damage that may be caused by using third party equipment or software.

Given the technological limitations of current optical disc writing drives, you may experience unexpected writing or rewriting errors due to disc quality or problems with hardware devices. Also, it is a good idea to make two or more copies of important data, in case of undesired change or loss of the recorded contents.

Disclaimer (DVD±R/RW drive)

TOSHIBA does not bear responsibility for the following:

- Damage to any CD-R/RW or DVD-R/-RW/+R/+RW disc that may be caused by writing or rewriting with this product.
- Any change or loss of the recorded contents of CD-R/RW or DVD-R/-RW/+R/+RW disc that may be caused by writing or rewriting with this product, or for any business profit loss or business interruption that may be caused by the change or loss of the recorded contents.
- Damage that may be caused by using third party equipment or software. Given the technological limitations of current optical disc writing drives, you may experience unexpected writing or rewriting errors due to disc quality or problems with hardware devices. Also, it is a good idea to make two or more copies of important data, in case of undesired change or loss of the recorded contents.

Before writing or rewriting

- Based on TOSHIBA's limited compatibility testing, we suggest the following manufacturers of CD-R/RW and DVD-R/+R/-RW/+RW/-RAM disc. However, in no event does TOSHIBA guarantee the operation, quality or performance of any disc. Disc quality can affect write or rewrite success rates

CD-R: TAIYO YUDEN CO., LTD.
Mitsui Chemicals Inc.
MITSUBISHI CHEMICAL CORPORATION
RICOH Co., Ltd.
Hitachi Maxell Ltd.

CD-RW: MITSUBISHI CHEMICAL CORPORATION
(High-Speed, RICOH Co., Ltd.
Multi-Speed)

DVD-R: **DVD Specifications for Recordable Disc for
General Version 2.0**
MITSUBISHI CHEMICAL CORPORATION RICOH
Co., Ltd.
TAIYO YUDEN CO., LTD.
PIONEER VIDEO CORPORATION
Matsushita Electric Industrial Co., Ltd.

DVD-RW: **DVD Specifications for Rerecordable Disc for
Version 1.1**
MITSUBISHI CHEMICAL CORPORATION RICOH
Co., Ltd.
VICTOR COMPANY OF JAPAN.LIMITED
TDK Corporation

DVD-RAM: **DVD Specifications for DVD-RAM Disc for
Version 2.0 or Version 2.1**
Matsushita Electric Industrial Co., Ltd.

- If the disc is poor in quality, dirty or damaged, writing or rewriting errors may occur. Be careful to check the disc for dirt or damage before you use it.
- The actual number of rewrites to CD-RW, DVD-RW or DVD+RW is affected by the quality of the disc and the way it is used.
- There are two types of DVD-R discs: authoring and general use discs. Do not use authoring discs. Only general use discs can be written to by a computer drive.
- You can use DVD-RAM discs that can be removed from a cartridge and DVD-RAM discs designed without a cartridge. You cannot use a disc with a 4.7 GB single-sided capacity or 9.4 GB double-sided capacity.
- Other DVD-ROM drives for computers or other DVD players may not be able to read DVD-R/-RW discs.
- You cannot partially delete any data written to a CD-RW, DVD-RW or DVD+RW disc.
- Data written to a CD-R/DVD-R/DVD+R disc cannot be deleted either in whole or in part.
- Data deleted (erased) from a CD-RW, DVD-RW and DVD+RW disc cannot be recovered. Check the content of the disc carefully before you delete it. If multiple drives that can write data to discs are connected, be careful not to delete data from the wrong drive.
- In writing to a DVD-R/-RW or DVD+R/+RW disc, some disc space is required for file management, so you may not be able to write the full capacity of the disc.
- Since the disc is based on the DVD standard, it might be filled with dummy data if the written data is less than about 1 GB. Even if you write only a small amount of data, it might take time to fill in the dummy data.
- DVD-RAM formatted by FAT32 cannot be read in Windows 2000 without DVD-RAM Driver Software.
- When multiple drives that can write data to discs are connected, be careful not to write to the wrong drive.
- Be sure to connect the AC adaptor before you write or rewrite.
- Before you enter standby/hibernation mode, be sure to finish DVD-RAM writing. Writing is finished if you can eject DVD-RAM media.
- Be sure to close all other software programs except the writing software.
- Do not run software such as a screen saver, which can put a heavy load on the CPU.
- Operate the computer in the full-power mode. Do not use power-saving features.
- Do not write while virus check software is running. Wait for it to finish and then disable virus detection programs including any software that checks files automatically in the background.
- Do not use hard disk utilities, including those intended to enhance HDD access speed. They may cause unstable operation and data damage.
- Write from the computer's HDD to the CD/DVD. Do not try to write from shared devices such as a LAN server or any other network device.

- Writing with software other than Drag'n Drop CD+DVD is not recommended.

When writing or rewriting

Please observe/consider the following when you write or rewrite to a CD-R/-RW, DVD-R/-RW/-RAM or DVD+R/+RW disc.

- Do not perform any of the following actions when writing or rewriting:
 - Change users in the Windows XP operating system.
 - Operate the computer for any other function, including using a mouse or Touch Pad or closing/opening the LCD panel.
 - Start a communication application such as a modem.
 - Apply impact or vibration to the computer.
 - Install, remove or connect external devices, including the following: PC card, SD card, USB devices, external display, i.LINK devices, optical digital devices.
 - Open the CD-RW/DVD-ROM, DVD±R/±RW or DVD Multi drive.
- Do not use standby/hibernation while writing or rewriting.
- Make sure writing or rewriting is completed before going into standby/hibernation. Writing is completed if you can open the CD-RW/DVD-ROM, DVD±R/±RW or DVD Multi drive tray.
- Set the computer on a level surface and avoid places subject to vibration such as airplanes, trains, or cars. Do not use an unstable surface such as a stand.
- Keep mobile phones and other wireless communication devices away from the computer.
- Always copy data from the HDD to the DVD-RAM. Do not use cut-and-paste. The original data will be lost if there is a write error.

Drag'n Drop CD+DVD

Note the following limitations when you use Drag'n Drop CD+DVD:

- DVD-Video cannot be created using Drag'n Drop CD+DVD.
- DVD-Audio cannot be created using Drag'n Drop CD+DVD.
- You cannot use Drag'n Drop CD+DVD's music CD function to record music to the DVD-R/-RW or DVD+R/+RW disc.
- Do not use the DISC Backup function of Drag'n Drop CD+DVD to copy DVD-Video and DVD-ROM with copyright protection.
- DVD-RAM disc cannot be backed up with the DISC Backup function of Drag'n Drop CD+DVD.
- You cannot backup a CD-ROM or CD-R/RW to DVD-R/-RW or DVD+R/+RW using the DISC Backup function of Drag'n Drop CD+DVD.
- You cannot back up DVD-ROM, DVD-Video or DVD-R/-RW or DVD+R/+RW to CD-R/RW using the DISC Backup function of Drag'n Drop CD+DVD.

- Drag'n Drop CD+DVD cannot record in packet format.
- You might not be able to use the DISC backup function of Drag'n Drop CD+DVD to back up a DVD-R/-RW or DVD+R/+RW disc that was made with other software on a different DVD-R/-RW or DVD+R/+RW recorder.
- If you add data to a DVD-R disc that you have already recorded to, you might not be able to read the added data under some circumstances. It cannot be read in 16-bit operating systems, such as Windows 98SE and Windows ME. In Windows NT4, you will need Service Pack 6 or later to read added data. In Windows 2000, you will need Service Pack 2 or later to read it. Some DVD-ROM and CD-RW/DVD-ROM drives cannot read added data regardless of the operating system.
- Drag'n Drop CD+DVD does not support recording to DVD-RAM discs. To record to a DVD-RAM, use Explorer or other utility.
- If you try to back up a DVD disc to a DVD-RW disc that was erased by the Quick erase option, you might get an error message. Use the Full erase option to clear the DVD-RW disc and try again.
- When you back up a DVD disc, be sure the source drive supports recording to DVD±R/±RW discs. If the source drive does not support recording to DVD±R/±RW discs, it might not be backed up correctly.
- When you back up a DVD-R, DVD-RW, DVD+R or DVD+RW, be sure to use the same type of disc.

Data Verification

To verify that data is written or rewritten correctly, follow the steps below before you write or rewrite a Data CD/DVD.

1. Right-click **Data BOX** and select **Options** to display the **DATA DISC Option** window.
2. Mark the **Record and Verify** check box and select **Byte compare**.
3. Click the **OK** button.

The "Record and Verify" function automatically checks whether data has been correctly recorded onto a CD/DVD. "Byte compare" compares the original data file with the data recorded on the CD/DVD and checks that the data completely matches.

Video (DVD-R/-RW/-RAM)

As for "InterVideo WinDVD Creator2 Platinum", only the model that can be written in to DVD is attached.

Note the following limitations when you write video to DVD:

- When installing, uninstalling or InterVideo WinDVD Creator 2 Platinum, the computer should be set to system administrator or equivalent privilege.
- When Drag'n Drop or similar software is resident in the computer's memory, the DVD Multi drive locks. In this situation, other software cannot be used to write data to the disc.
- While you are editing DVD-R/-RW/-RAM, you can display previews. However, if an application other than WinDVD is running, the preview might not display properly. To ensure proper display of previews, do not start other applications while you are editing DVD-R/-RW/-RAM disc.
- Do not change the resolution or the number of screen colors while InterVideo WinDVD Creator 2 Platinum is running.
- Although the online manual and Help files indicate that JPEG files can be used, in fact, they cannot be used.
- InterVideo WinDVD Creator 2 Platinum cannot make DVD-Audio, VideoCD, and miniDVD.
- DVD-R/-RW discs cannot be written in VR format.
- It may take several hours for InterVideo WinDVD Creator 2 Platinum to convert video to MPEG format, and several hours more to save the MPEG file to a DVD Multi drive.
- In order to write to a DVD-RW disc that has already been written to using InterVideo WinDVD Creator 2 Platinum, you will first have to delete all of the data with Drag'n Drop CD+DVD or similar software.
- You will need 2 GB of empty hard disk space for every hour to write to a DVD-R/-RW disc.
- You cannot edit DVD-RAM video data that has copyright protection, using InterVideo WinDVD Creator 2 Platinum.

Media care

This section provides tips on protecting data stored on your CD/DVDs and diskettes.

Handle your media with care. The following simple precautions will increase the lifetime of your media and protect the data stored on them:

CD/DVDs

1. Store your CD/DVDs in the container they came in to protect them and keep them clean.
2. Do not bend the CD/DVD.
3. Do not write on, apply a sticker to, or otherwise mar the surface of the CD/DVD that contains data.
4. Hold the CD/DVD by its outside edge or the edge on the center hole. Fingerprints on the surface can prevent the drive from properly reading data.
5. Do not expose to direct sunlight, extreme heat or cold. Do not place heavy objects on your CD/DVDs.
6. If your CD/DVDs become dusty or dirty, wipe them with a clean dry cloth. Wipe from the center out, do not wipe in a circular direction around the CD/DVD. If necessary, use a cloth dampened in water or a neutral cleaner. Do not use benzine, thinner or similar cleaner.

Diskettes

1. Store your diskettes in the container they came in to protect them and keep them clean. If a diskette is dirty, do not use cleaning fluid. Clean it with a soft damp cloth.
2. Do not slide back the diskette's protective metal covering or touch the diskette's magnetic surface. Fingerprints may prevent the floppy disk drive from reading data from the diskette.
3. Data may be lost if the diskette is twisted; bent; or exposed to direct sunlight, extreme heat or cold.
4. Do not place heavy objects on your diskettes.
5. Do not eat, smoke, or use erasers near your diskettes. Foreign particles inside the diskette's jacket can damage the magnetic surface.
6. Magnetic energy can destroy the data on your diskettes. Keep your diskettes away from speakers, radios, television sets and other sources of magnetic fields.

Sound System

Using the microphone

Your computer has a built-in microphone that can be used to record monaural sounds into your applications. It can also be used to issue voice commands to applications that support such functions.

Since your computer has a built-in microphone and speaker, “howling” may be heard under certain conditions. Howling occurs when sound from the speaker is picked up in the microphone and amplified back to the speaker, which amplifies it again to the microphone.

This howling occurs repeatedly and causes a very loud, high-pitched noise. It is a common phenomenon that occurs in any sound system when the microphone input is output to the speaker (throughput) and the speaker volume is too loud or too close to the microphone. You can control throughput by adjusting the volume of your speaker or through the Mute function.

To adjust the volume or activate Mute, click **start**, point to **All Programs**, point to **Accessories**, point to **Entertainment** and click **Volume control**. In the **Master volume** panel, you can use the side bars to adjust the volume level or click **Mute** at the bottom of the panel.

SoundMAX control panel

The SoundMAX control panel lets you control additional functions for the Microphone Enhancement and Audio Power Management. To launch the SoundMAX Control Panel, follow the steps below.

1. Click **Start** and click **Control Panel**.
2. If you are viewing the Control Panel in Category View, click on **Switch to Classic View**.
3. Double-click the **SoundMAX** icon.

The **Microphone Setup** allows you to optimize the microphone input settings for your particular configuration. Choose **Standard Microphone** if you have an ordinary desktop microphone. Choose **Headset** if you have a wearable microphone that is positioned directly in front of your mouth.

You can launch the **Setup Wizard** from the Control Panel to help you to automatically set proper microphone input volumes and ensure that your voice input(s) are working correctly. As you speak into the microphone, the Sound Meter indicates the audio signal that your PC is receiving.

The **Noise Reduction** enhancement helps to eliminate ambient noise from the voice input signal to provide a clean and clear signal to applications. This feature can be used with any microphone.

The audio controller can be powered down when the audio function is idle. To enable the Audio Power Management, follow the steps below.

1. Clicked the **Power Management** tab.
2. Select the **Normal Power Savings** in the Power Mode pull-down list.



*If the **No Power Savings** is selected, the audio controller always runs.*

If you want a more effect for the power management, you can select another mode, the **High Power Savings** which can save the power than the Normal Power Savings. To select it, follow the steps below.

1. Clicked the **Power Management** tab.
2. Select the **High Power Savings** in the Power Mode pull-down list.
3. Input a time in **Power Save Delay (Seconds)**.



*If the **High Power Saving** is selected, you need to play an audio file once before you use a microphone or play an audio CD by the analog CD audio.*

Audio Effect

TOSHIBA Audio Effect provides you with a hands-free environment for holding mutual communication via the Internet Protocol or Local Area Network. If you wish to communicate with someone on your computer, you can use a messenger application. However, with such an application, you would hear your own voice returning to you as echo during the communication if you did not use a headset system or headphone. TOSHIBA Audio Effect will reduce these echoes generated on your computer. For more information on using the TOSHIBA Audio Effect, refer to its help.

Modem

This section describes how to connect and disconnect the internal modem to and from a telephone jack.



The internal modem does not support voice functions. All data and fax functions are supported.



- *In case of a lightning storm, unplug the modem cable from the telephone jack.*
- *Do not connect the modem to a digital telephone line. A digital line will damage the modem.*

Region selection

Telecommunication regulations vary from one region to another, so you will need to make sure the internal modem's settings are correct for the region in which it will be used.

To select a region, follow the steps below.

1. Click **start**, point to **All Programs**, point to **TOSHIBA Internal Modem** and click **Region Select Utility**.



Do not use the Country/Region Select function in the Modem setup utility in the Control Panel if the function is available. If you change the Country/Region in the Control Panel, the change may not take effect.

2. The Region Selection icon will appear in the Windows Task Bar. Click the icon with the primary mouse button to display a list of regions that the modem supports. A sub menu for telephony location information will also be displayed. A check will appear next to the currently selected region and telephony location.
3. Select a region from the region menu or a telephony location from the sub-menu.
 - When you click a region it becomes the modem's region selection, and the New Location for telephony will be set automatically.
 - When you select a telephony location, the corresponding region is automatically selected and it becomes the modem's current region setting.

Properties menu

Click the icon with the secondary mouse button to display properties menu on the screen.

Setting

You can enable or disable the following settings:

AutoRun Mode

The Region Select utility starts automatically when you start up the operating system.

Open the Dialing Properties dialog box after selecting region.

The dialing properties dialog box will be displayed automatically after you select the region.

Location list for region selection.

A submenu appears displaying location information for telephony.

Open dialog box, if the modem and Telephony Current Location region code do not match.

A warning dialog box is displayed if current settings for region code and telephony location are incorrect.

Modem Selection

If the computer cannot recognize the internal modem, a dialog box is displayed. Select the COM port for your modem to use.

Dialing Properties

Select this item to display the dialing properties.



If you are using the computer in Japan, the Telecommunications Business Law requires that you select Japan region mode. It is illegal to use the modem in Japan with any other selection.

Connecting

To connect the modem cable, follow the steps below.



The modular cable that comes with the computer must be used to connect a modem. Connect the end of the modular cable with the core to the computer.



- *In case of a lightning storm, unplug the modem cable from the telephone jack.*
- *Do not connect the modem to a digital telephone line. A digital line will damage the modem.*

1. Plug one end of the modular cable into the modem jack.
2. Plug the other end of the modular cable into a telephone jack.

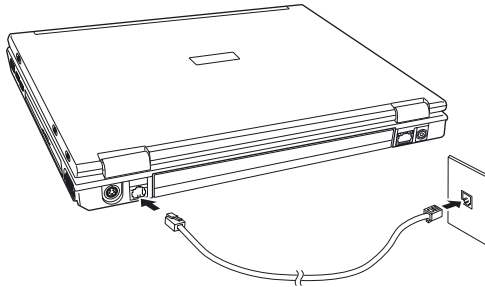

Connecting the internal modem



Do not pull on the cable or move the computer while the cable is connected.



If you use a storage device such as an optical drive or HDD connected to a 16-bit PC card, you might experience the following modem problems:

- Modem speed is slow or communication is interrupted.
- Skips may occur in sound.

Disconnecting

To disconnect the internal modem cable, follow the steps below.

1. Pinch the lever on the connector in the telephone jack and pull out the connector.
2. Disconnect the cable from the computer in the same manner.
3. In the same way, pull the cable's other connector out of the computer.

Wireless communications

The computer's wireless communication function supports both wireless LAN and Bluetooth devices.

Wireless LAN

The Wireless LAN is compatible with other LAN systems based on Direct Sequence Spread Spectrum /Orthogonal Frequency Division Multiplexing radio technology that complies with IEEE802.11 wireless LAN standard (Revision A, B or G) and Turbo Mode.

- Automatic Transmit Rate Select mechanism in the transmit range of 54, 48, 36, 24, 18, 12, 9 and 6Mbit/s. (Revision A and G, Revision A/B, B/G, A/B/G combo type)
- Automatic Transmit Rate Select mechanism in the transmit range of 11, 5.5, 2 and 1Mbit/s. (Revision B)
- Automatic Transmit Rate Select mechanism in the transmit range of 108, 96.72, 48, 36, 24, 18 and 12Mbit/s. (Turbo Mode, Revision A/B/G combo type)
- Frequency Channel Selection (Revision A/Turbo Mode:5GHz, Revision B/G: 2.4GHz)
- Roaming over multiple channels
- Card Power Management
- Wired Equivalent Privacy (WEP) data encryption, based on the 152 bit encryption algorithm.(Revision B/G, A/B/G combo type) Wired Equivalent Privacy (WEP) data encryption, based on the 128 bit encryption algorithm.(Revision A/B combo, B only type)
- Advanced Encryption Standard (AES) data encryption, based on 256bit encryption algorithm.(Revision B/G, A/B/G combo type)



Wake-up on LAN does not function on a Wireless LAN.

Security

1. Be sure to enable WEP (encryption) function. Otherwise your computer will allow the illegal access by outsider through wireless LAN to cause illegal intrusion, eavesdropping, and loss or destruction of stored data. TOSHIBA strongly recommend the customer to enable the WEP function.
2. TOSHIBA is not liable for the eavesdropping of data due to the use of wireless LAN and the damage thereof.

Bluetooth wireless technology

Bluetooth™ wireless technology eliminates the need for cables between electronic devices such as desktop computers, printers and mobile phones. You cannot use the built-in Bluetooth functions and an optional Bluetooth SD card 2 simultaneously.

Bluetooth wireless technology has the following features:

Worldwide operation

The Bluetooth radio transmitter and receiver operate in the 2.4 GHz band, which is license-free and compatible with radio systems in most countries in the world.

Radio links

You can easily establish links between two or more devices. The link is maintained even if the devices are not within line of sight.

Security

Two advanced security mechanisms ensure a high level of security:

- Authentication prevents access to critical data and makes it impossible to falsify the origin of a message.
- Encryption prevents eavesdropping and maintains link privacy.

Wireless communication switch

You can enable or disable wireless LAN and Bluetooth functions, with the on/off switch. No transmissions are sent or received when the switch is off. Slide the switch to the right to turn it on and to the left to turn it off.



Set the switch to off in airplanes and hospitals. Check the indicator. It will stop glowing when the wireless communication function is off.

Wireless communication Indicator

The wireless communication indicator indicates the status of the wireless communication functions.

Indicator status	Indication
Indicator off	Wireless communication switch is set to off. Automatic power down because of overheating. Power malfunction
Indicator glows	Wireless communication switch is on. Wireless LAN or Bluetooth is turned on by an application.

If you used the Task Bar to disable W-LAN, restart the computer or follow the procedures below to enable the system to recognize W-LAN. Open or click the following: **start, Control Panel, System, Hardware Device Manager, Network adapters, Atheros AR5001X+ Wireless Network Adaptor or Intel PRO/Wireless LAN 2100 3B Mini PCI Adaptor or Intel PRO/Wireless LAN 2100A LAN Mini PCI Adaptor** and **enable**.

LAN

The computer has built-in support for Ethernet LAN (10 megabits per second, 10BASE-T), Fast Ethernet LAN (100 megabits per second, 100BASE-Tx) and Gigabit Ethernet LAN (1000 megabits per second, 1000BASE-T). Some models are equipped with a Gigabit Ethernet LAN. This section describes how to connect/disconnect to a LAN.



Do not install or remove an optional memory module while Wake-up on LAN is enabled.



The Wake-up on LAN function consumes power even when the system is off. Leave the AC adaptor connected while using this feature.

LAN cable types



The computer must be configured properly before connecting to a LAN. Logging onto a LAN using the computer's default settings could cause a malfunction in LAN operation. Check with your LAN administrator regarding set-up procedures.

If you are using Gigabit Ethernet LAN (1000 megabits per second, 1000BASE-T), be sure to connect with a CAT5 cable or a CAT5E cable. (A CAT5E cable is recommended.) You cannot use a CAT3 cable.

If you are using Fast Ethernet LAN (100 megabits per second, 100BASE-TX), be sure to connect with a CAT5 cable. You cannot use a CAT3 cable.

If you are using Ethernet LAN (10 megabits per second, 10BASE-T), you can connect with either a CAT5 or a CAT3.

Connecting LAN cable

To connect the LAN cable, follow the steps below.

1. Turn off the power to the computer and to all external devices connected to the computer.
2. Plug one end of the cable into the LAN jack. Press gently until you hear the latch click into place.

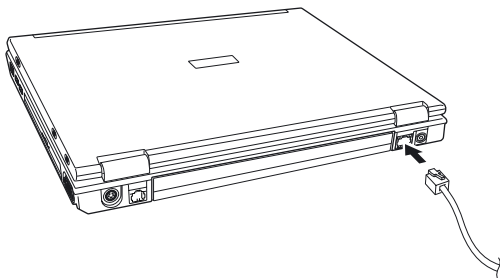

Connecting the LAN cable

3. Plug the other end of the cable into a LAN hub connector. Check with your LAN administrator before connecting to a hub.



*When the computer is exchanging data with the LAN, the **LAN Active** indicator glows orange. When the computer is connected to a LAN hub but is not exchanging data, the **Link** indicator glows green.*

Disconnecting LAN cable

To disconnect the LAN cable, follow the steps below.



Make sure the LAN Active indicator (orange LED) is out before you disconnect the computer from the LAN.

1. Pinch the lever on the connector in the computer's LAN jack and pull out the connector.
2. Disconnect the cable from the LAN hub in the same manner. Check with your LAN administrator before disconnecting from the hub.

Cleaning the computer

To help ensure long, trouble-free operation, keep the computer free of dust and use care with liquids around the computer.

- Be careful not to spill liquids into the computer. If the computer does get wet, turn the power off immediately and let the computer dry completely before you turn it on again.
- Clean the computer using a slightly damp (with water) cloth. You can use glass cleaner on the display. Spray a small amount of cleaner on a soft, clean cloth and wipe the screen gently with the cloth.



Never spray cleaner directly onto the computer or let liquid run into any part of it. Never use harsh or caustic chemical products to clean the computer.

- Remove the dust from the cooling vents on the Left side of the computer regularly with vacuum cleaner. See Chapter 2, *The Grand Tour, Left side.*

Moving the computer

The computer is designed for rugged durability. However, a few simple precautions taken when moving the computer will help ensure trouble-free operation.

- Make sure all disk activity has ended before moving the computer. Check the **Disk** and **Slim Select Bay** indicators on the computer.
- If a CD/DVD is in the drives, remove it. Also make sure the drawer is securely closed.
- Turn off the power to the computer.
- Disconnect the AC adaptor and all peripherals before moving the computer.
- Close the display. Do not pick up the computer by its display panel.
- Close all port covers.
- Use the carrying case when transporting the computer.

Heat dispersal

To protect from overheating, the CPU has an internal temperature sensor. If the computer's internal temperature rises to a certain level, the cooling fan is turned on or the processing speed is lowered. You can select whether to control the CPU temperature by turning on the fan first, then if necessary, lowering the CPU speed. Or, by lowering the CPU speed first, then if necessary, turning on the fan. Use the *Cooling Method* item of the *Basic Setup* tab in TOSHIBA Power Saver.

Maximum Performance	Turns on the fan first, then if necessary, lowers the CPU processing speed.
Performance	Uses a combination of the fan and lowering the CPU processing speed.
Battery optimized	Lowers the CPU processing speed first, then if necessary turns on the fan.

When the CPU temperature falls to a normal range, the fan is turned off and the CPU operation returns to standard speed.



If the CPU temperature reaches an unacceptably high level with either setting, the system automatically shuts down to prevent damage. Data in memory will be lost.

Chapter 5

The Keyboard

The computer's keyboard layouts are compatible with a 101/102-key enhanced keyboard. By pressing some keys in combination, all the 101/102-key keyboard functions can be executed on the computer.

The number of keys on your keyboard depends on which country/region's keyboard layout your computer is configured with. Keyboards for numerous languages are available.

There are five types of keys: typewriter keys, keypad overlay, function keys, soft keys and cursor control keys.

Typewriter keys

The typewriter keys produce the upper- and lower-case letters, numbers, punctuation marks, and special symbols that appear on the screen.

There are some differences, however, between using a typewriter and using a computer keyboard:

- Letters and numbers produced in computer text vary in width. Spaces, which are created by a "space character," may also vary depending on line justification and other factors.
- The lowercase l (el) and the number 1 (one) are not interchangeable on computers as they are on a typewriter.
- The uppercase O (oh) and the 0 (zero) are not interchangeable.
- The **Caps Lock** function key locks only the alphabetic characters in uppercase while the shift lock on a typewriter places all keys in the shifted position.
- The **Shift** keys, the **Tab** key, and the **BkSp** (backspace) key perform the same function as their typewriter counterparts but also have special computer functions.

F1 ... F12 function keys

The function keys (not to be confused with **Fn**) are the 12 keys at the top of your keyboard. These keys function differently from other keys.



F1 through **F12** are called function keys because they execute programmed functions when pressed. Used in combination with the **Fn** key, keys marked with icons execute specific functions on the computer. See the section, *Soft keys: Fn key combinations*, in this chapter. The function executed by individual keys depends on the software you are using.

Soft keys: Fn key combinations

The **Fn** (function) is unique to TOSHIBA computers and is used in combination with other keys to form soft keys. Soft keys are key combinations that enable, disable or configure specific features.



Some software may disable or interfere with soft-key operations. Soft-key settings are not restored by the Standby feature.

Emulating keys on enhanced keyboard

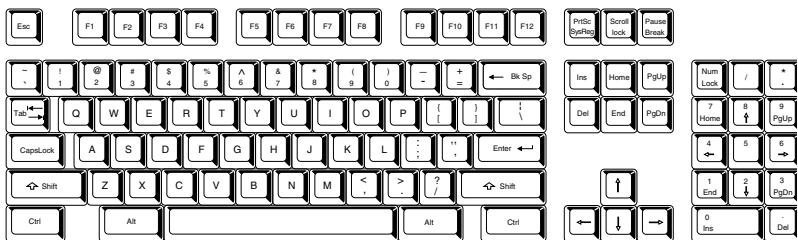

A 101-key enhanced keyboard layout

The keyboard is designed to provide all the features of the 101-key enhanced keyboard, shown in figure above. The 101/102-key enhanced keyboard has a numeric keypad and scroll lock key. It also has additional **Enter** and **Ctrl** keys to the right of the main keyboard. Since the keyboard is smaller and has fewer keys, some of the enhanced keyboard functions must be simulated using two keys instead of one on the larger keyboard.

Your software may require you to use keys that the keyboard does not have. Pressing the **Fn** key and one of the following keys simulates the enhanced keyboard's functions.

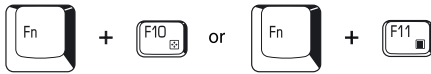

Press **Fn + F10** or **Fn + F11** to access the integrated keypad. When activated, the keys with gray markings on the bottom edge become numeric keypad keys (**Fn + F11**) or cursor control keys (**Fn + F10**). Refer to the *Keypad overlay* section in this chapter for more information on how to operate these keys. The power on default for both settings is off.



Press **Fn + F12 (ScrLock)** to lock the cursor on a specific line. The power on default is off.



Press **Fn + Enter** to simulate **Enter** on the enhanced keyboard's numeric keypad.



Press **Fn + Ctrl** to simulate the enhanced keyboard's right **Ctrl** key.

Hot keys

Hot keys (**Fn** + a function or Esc key) let you enable or disable certain features of the computers.



Sound mute: Pressing **Fn + Esc** in a Windows environment turns sound on or off. When you press these hot keys, the current setting will change and be displayed as an icon.



Instant security: Press **Fn + F1** to blank the screen to prevent others from accessing your data. To restore the screen and original settings, press any key or press the Dual Pointing Device. If a screensaver password is registered, a dialog box will appear. Enter the screensaver password and click **OK**. If no password is set, the screen will be restored when you press any key or press the Dual Pointing Device.



Power save mode: Pressing **Fn + F2** changes the power save mode.

If you press **Fn + F2** in a Windows environment, the Power Save Mode is displayed in a dialog box similar to the one below. Continue holding down **Fn** and press **F2** again to change the setting. You can also change this setting through the *profile* item in TOSHIBA Power Saver.



Standby: When you press **Fn + F3**, the computer enters Standby. To avoid entering Standby unexpectedly, a dialog box appears for verification. However, if you select the check box, it will not appear in the future.



Hibernation: When you press **Fn + F4**, the computer enters Hibernation. To avoid entering Hibernation unexpectedly, a dialog box appears for verification. However, if you select the check box, it will not appear in the future.



Display selection: Press **Fn + F5** to change the active display device. When you press these hot keys, a dialog box appears. Only selectable devices will be displayed. Hold down **Fn** and press **F5** again to change the device. When you release **Fn** and **F5**, the selected device will change. If you hold down these hot keys for five seconds the selection will return to **LCD**.



LCD Display Brightness: Pressing **Fn + F6** decreases the display brightness in decrements. When you press these hot keys, the current setting will be displayed for two seconds by an icon. You can also change this setting through the *Screen brightness* item of the *Basic Setup* tab in TOSHIBA Power Saver.



LCD Display Brightness: Pressing **Fn + F7** increases the display brightness in increments. When you press these hot keys, the current setting will be displayed for two seconds by a pop-up icon. You can also change this setting through the *Screen brightness* item of the *Basic Setup* tab in TOSHIBA Power Saver.



- *The brightness level is always set at the maximum value for about 18 seconds, when the LCD turns on. After 18 seconds, the brightness level will appear at the Power Save Mode setting or you can change it manually.*
- *Display clarity increases with the brightness level.*



Wireless setting: If your computer has both Bluetooth and wireless LAN functions, you can press **Fn + F8** to select which type of wireless communication you want to use. When you press these hot keys, a dialog box will appear. Continue holding down **Fn** and press **F8** to change the setting. If wireless communication is turned off, **Disabled Wireless Communication Switch** will be displayed.



If no wireless communication device is installed, no dialog box will appear.



Dual Pointing Device: Pressing **Fn + F9** in a windows environment enables or disables the Dual Pointing Device function. When you press these hot keys, the current setting will change and be displayed as an icon.



Display resolution selection: Press **Fn + space keys** to change the display resolution. Each time when you press these hot keys, the display resolution changes as follows: From the current resolution (the original resolution) to 1024X768, from 1024X768 to 800X600, from 800X600 to the original resolution.



TOSHIBA Zooming Utility (reduce): To reduce the icon size on the desktop or the application window, press the **1** key while holding down the **Fn** key.



TOSHIBA Zooming Utility (enlarge): To enlarge the icon size on the desktop or the application window, press the **2** key while holding down the **Fn** key.

Fn Sticky key

You can use the TOSHIBA Accessibility Utility to make the **Fn** key sticky, that is, you can press it once, release it, and then press an “**F number**” key. To start the TOSHIBA Accessibility Utility, click **start**, point to **All Programs**, point to **TOSHIBA**, point to **Utilities** and click **Accessibility**.

Windows special keys

The keyboard provides two keys that have special functions in Windows : Windows logo key activates the **start** menu and the other, the application key, has the same function as the secondary mouse button.



This key activates the Windows **start** menu.



This key has the same function as the secondary mouse button.

Keypad overlay

Your computer's keyboard does not have an independent numeric keypad, but its numeric keypad overlay functions like one.

The keys in the center of the keyboard with gray letters make up the numeric keypad overlay. The overlay provides the same functions as the numeric keypad on the 101/102-key enhanced keyboard in next figure.

Turning on the overlays

The numeric keypad overlay can be used for numeric data input or cursor and page control.

Arrow mode

To turn on the Arrow mode, press **Fn + F10**. The Arrow mode **F10** indicator lights. Now try cursor and page control using the keys shown in next figure. Press **Fn + F10** again to turn off the overlay.

Numeric mode

To turn on the Numeric mode, press **Fn + F11**. The Numeric mode **F11** indicator lights. Now try numeric data entry using the keys in next figure. Press **Fn + F11** again to turn off the overlay.

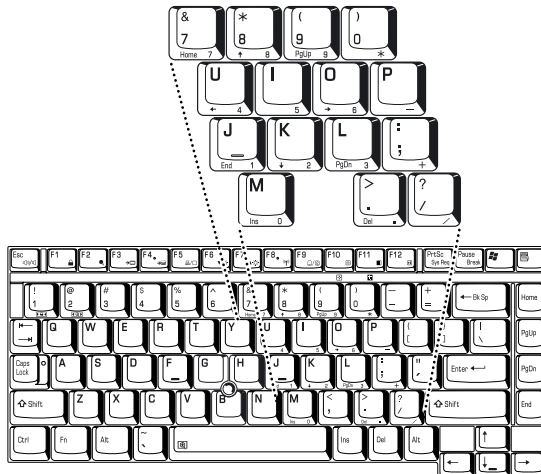

The numeric keypad overlay

Temporarily using normal keyboard (overlay on)

While using the overlay, you can temporarily access the normal keyboard without turning off the overlay:

1. Hold **Fn** and press any other key. All keys will operate as if the overlay were off.
2. Type upper-case characters by holding **Fn + Shift** and pressing a character key.
3. Release **Fn** to continue using the overlay.

Temporarily using overlay (overlay off)

While using the normal keyboard, you can temporarily use the keypad overlay without turning it on:

1. Press and hold down **Fn**.
2. Check the keyboard indicators. Pressing **Fn** turns on the most recently used overlay. If the Numeric mode indicator lights, you can use the overlay for numeric entry. If the Arrow mode indicator lights, you can use the overlay for cursor and page control.
3. Release **Fn** to return to normal keyboard operation.

Temporarily changing modes

If the computer is in **Numeric mode**, you can switch temporarily to **Arrow mode** by pressing a shift key.

If the computer is in **Arrow mode**, you can switch temporarily to **Numeric mode** by pressing a shift key.

Generating ASCII characters

Not all ASCII characters can be generated using normal keyboard operation. But, you can generate these characters using their ASCII codes.

With the overlay on:

1. Hold down **Alt**.
2. Using the overlay keys, type the ASCII code.
3. Release **Alt**, and the ASCII character appears on the display screen.

With the overlay off:

1. Hold down **Alt + Fn**.
2. Using the overlay keys, type the ASCII code.
3. Release **Alt + Fn**, and the ASCII character appears on the display screen.

Chapter 6

Power and Power-Up Modes

The computer’s power resources include the AC adaptor and internal batteries. This chapter gives details on making the most effective use of these resources including charging and changing batteries, tips for saving battery power, and power up modes.

Power conditions

The computer’s operating capability and battery charge status are affected by the power conditions: whether an AC adaptor is connected, whether a battery is installed and what the charge level is for the battery.

		Power on	Power off (no operation)
AC adaptor connected	Main Battery fully charged	<ul style="list-style-type: none"> Operates No charge LED: Battery green DC IN 15V green 	<ul style="list-style-type: none"> No charge LED: Battery green DC IN 15V green
	Main Battery partially charged or no charge	<ul style="list-style-type: none"> Operates Charge*¹ LED: Battery orange DC IN 15V green 	<ul style="list-style-type: none"> Quick charge*¹ LED: Battery orange DC IN 15V green
	No Main battery installed	<ul style="list-style-type: none"> Operates No charge LED: Battery off DC IN 15V green 	<ul style="list-style-type: none"> No charge LED: Battery off DC IN 15V green

		Power on	Power off (no operation)
AC adaptor connected	2nd battery fully charged	<ul style="list-style-type: none"> Operates No charge LED: 2nd Battery green DC IN 15V green 	<ul style="list-style-type: none"> No charge LED: 2nd battery green DC IN 15V green
	2nd Battery partially charged or no charge	<ul style="list-style-type: none"> Operates Charge^{*2} LED: 2nd battery orange DC IN 15V green 	<ul style="list-style-type: none"> Quick charge^{*2} LED: 2nd battery orange DC IN 15V green
	No 2nd battery installed	<ul style="list-style-type: none"> Operates No charge LED: 2nd battery off DC IN 15V green 	<ul style="list-style-type: none"> No charge LED: 2nd Battery off DC IN 15V green
AC adaptor not connected	Main battery charge is above low battery trigger point	<ul style="list-style-type: none"> Operates LED: Battery off DC IN 15V off 	–
	Main battery charge is below low battery trigger point	<ul style="list-style-type: none"> Operates LED: Battery flashes orange DC IN 15V off 	–
	Main battery charge is exhausted	Computer shuts down ^{*3}	–
	No main battery installed	<ul style="list-style-type: none"> No operation ^{*4} LED: Battery off DC IN 15V off 	–
AC adaptor not connected	2nd battery charge is above low battery trigger point	<ul style="list-style-type: none"> Operates LED: 2nd battery off DC IN 15V off 	–
	2nd battery charge is below low battery trigger point	<ul style="list-style-type: none"> Operates LED: 2nd battery flashes orange DC IN 15V off 	–
	2nd battery charge is exhausted	Computer shuts down ^{*3}	–
	No 2nd battery is installed	<ul style="list-style-type: none"> No operation ^{*5} LED: 2nd battery off DC IN 15V off 	–



2nd battery indicator refers to the **Slim Select Bay** indicator when a secondary battery is installed.

- *1 When the 2nd battery is not charging.
- *2 When the main battery is not charging.
- *3 For the computer to shut down in hibernation mode, the hibernation feature must be enabled in two places in TOSHIBA Power Saver: the Hibernate window and the Battery Alarm item of the Alarm window. If a main battery and a 2nd battery are installed, the computer does not shut down until the charge in both batteries is exhausted.
- *4 When no 2nd battery is installed.
- *5 When no main battery is installed.



When batteries are charged, the main battery is charged first. When it is fully charged, the 2nd battery is charged.

Power indicators

As shown in the above table, the **Battery**, **Slim Select Bay**, **DC IN 15V** and **Power** indicators on the system indicator alert you to the computer's operating capability and battery charge status.

Battery indicators

Check the **Battery** indicator to determine the status of the main battery and the **Slim Select Bay** indicator to determine the status of the secondary battery. The following indicator lights indicate the battery status:

Flashing orange	The battery charge is low. The AC adaptor must be connected to recharge the battery.
Orange	Indicates the AC adaptor is connected and charging the battery.
Green	Indicates the AC adaptor is connected and the battery is fully charged.
No light	Under any other conditions, the indicator does not light.



If the battery becomes too hot while it is being charged, the charge will stop and the battery indicator will go out. When the battery's temperature falls to a normal range, charge will resume. This occurs whether the computer's power is on or off.

DC IN 15V indicator

Check the **DC IN 15V** indicator to determine the power status with the AC adaptor connected:

Green	Indicates the AC adaptor is connected and supplying proper power to the computer.
Flashing orange	Indicates a problem with the power supply. Plug the AC adaptor into another outlet. If it still does not operate properly, contact your dealer.
No light	Under any other conditions, the indicator does not light.

Power indicator

Check the **Power** indicator to determine the power status:

Green	Indicates power is being supplied to the computer and the computer is turned on.
Blinking orange	Indicates power is being supplied to the computer while the computer is in Standby mode. The indicator turns on for one second and off for two seconds.
No light	Under any other conditions, the indicator does not light.

Battery types

The computer has three types of batteries:

- Battery packs – main, 2nd (option) and High capacity (option)
- Real Time Clock (RTC) battery

Main battery

When the AC adaptor is not connected, the computer's main power source is a removable lithium ion battery pack, also referred to in this manual as the main battery. You can purchase additional battery packs for extended use of the computer away from an AC power source.

Before you remove the battery pack, set the computer to Hibernation mode or save your data and shut down the computer. Do not change the battery pack while the AC adaptor is connected.



- *The battery pack is a lithium ion battery, which can explode if not properly replaced, used, handled or disposed of. Dispose of the battery as required by local ordinances or regulations. Use only batteries recommended by TOSHIBA as replacements.*
- *Do not remove the battery pack while the computer is in Standby mode. Data is stored in RAM, so if the computer loses power it will be lost. When the computer is powered off in Standby mode, and the AC adaptor is not connected, the main battery pack and optional 2nd battery pack supply power to maintain data and program in memory. If the battery pack(s) is completely discharged, Standby mode does not function and the computer loses all data in memory.*

To ensure that the battery pack maintains its maximum capacity, operate the computer on battery power at least once a month until the battery pack is fully discharged. Refer to *Extending battery life* in this chapter for procedures. If the computer is continuously operated on AC power through an AC adaptor for an extended period, more than a month, the battery may fail to retain a charge. It may not function efficiently over the expected life of the battery and the **Battery** indicator may not indicate a low-battery condition.

2nd battery (option)

An optional 2nd battery can be installed in the Slim Select Bay to increase your battery operating time. Note the caution on Standby mode in the previous section *Main battery*.



The 2nd battery pack is a lithium ion battery, which can explode if not properly replaced, used, handled or disposed of. Dispose of the battery as required by local ordinances or regulations. Use only batteries recommended by TOSHIBA as replacements.

High capacity battery

An optional high capacity battery is installable instead of a Main battery. The capacity of High capacity battery is approximately double the capacity of Main battery. The connection method of High capacity battery is the same as that of Main battery.

- *The battery pack is a lithium ion battery, which can explode if not properly replaced, used, handled or disposed of. Dispose of the battery as required by local ordinances or regulations. Use only batteries recommended by TOSHIBA as replacements.*
- *Do not remove the battery pack while the computer is in Standby mode. Data is stored in RAM, so if the computer loses power it will be lost. When the computer is powered off in Standby mode, and the AC adaptor is not connected, the main battery pack and optional 2nd battery pack supply power to maintain data and program in memory. If the battery pack(s) is completely discharged, Standby mode does not function and the computer loses all data in memory.*
- *Do not have only High capacity battery, when having connected High capacity battery with the computer.*

Real Time Clock battery

The Real Time Clock (RTC) battery provides power for the internal real time clock and calendar. It also maintains the system configuration.

If the RTC battery becomes completely discharged, the system loses this data and the real time clock and calendar stop working. The following message appears when you turn on the power:



```
**** RTC battery is low or CMOS checksum is inconsistent ****
Press [F1] key to set Date/Time.
```



The computer's RTC battery is a lithium ion battery and should be replaced only by your dealer or by a TOSHIBA service representative. The battery can explode if not properly replaced, used, handled or disposed of. Dispose of the battery as required by local ordinances or regulations.



You can change the setting of RTC by pressing F1 key. Refer to Chapter 9 Troubleshooting for the detail.

Care and use of the battery pack

The battery pack is a vital component of portable computing. Taking proper care of it will help ensure longer operating time on battery power as well as a longer life for your battery pack. Follow the instructions in this section carefully to ensure safe operation and maximum performance.

Safety precautions

Mishandling of batteries can cause death, serious injury or property damage. Carefully observe the following advisories:

Danger: Indicates an imminently hazardous situation, which could result in death or serious injury, if you do not follow instructions.

Warning: Indicates a potentially hazardous situation, which could result in death or serious injury, if you do not follow instructions.

Caution: Indicates a potentially hazardous situation, which if not avoided, may result in moderate or minor injury or property damage.

Note: Provides important information.

Danger

1. Never try to dispose of the battery pack by burning or expose it to a heating device such as a microwave oven. The battery pack could explode and cause bodily injury.
2. Never try to disassemble, repair or otherwise tamper with a battery pack. The battery pack will overheat and ignite. Leakage of caustic alkaline solution or other electrolytic substances will cause fire or injury, possibly resulting in death or serious injury.
3. Never short-circuit the battery pack by contacting the terminals with a metal object. A short-circuit can cause fire or otherwise damage the battery pack and possibly cause injury. To avoid accidental short-circuit, always wrap the battery pack in plastic and cover the terminals with electrical tape when storing or disposing of the battery pack.
4. Never puncture the battery pack with a nail or other sharp object. Never strike it with a hammer or other object. Never step on it.
5. Never try to charge the battery pack in any manner other than that described in the user's manual. Never connect the battery pack to a plug socket or to an automobile's cigarette lighter socket. It may rupture or ignite.
6. Use only the battery pack supplied with the computer or other device or a battery pack approved by the computer or device's manufacturer. Battery packs have different voltages and terminal polarities. Use of an improper battery could cause smoke, fire or rupture of the battery pack.
7. Never subject a battery pack to heat, such as storage near a heat source. Exposure to heat can cause the battery pack to ignite, explode or leak caustic liquid and cause death or serious injury. It could also fail or malfunction causing data loss.

8. Never expose the battery pack to abnormal shock, vibration or pressure. The battery pack's internal protective device will fail, causing it to overheat, explode, ignite or leak caustic liquids possibly resulting in death or serious injury.
9. Never let a battery pack become wet. A wet battery pack will overheat, ignite or rupture possibly resulting in death or serious injury.

Warning

1. Never allow caustic electrolyte fluid leaked from a battery pack to contact your eyes, skin or clothing. If caustic electrolyte fluid should contact your eyes, immediately wash your eyes with large amounts of running water and seek medical attention, to help prevent eye damage. If electrolyte fluid should contact your skin immediately wash it under running water to prevent rash. If it contacts your clothes, promptly remove them to prevent the fluid from contacting your skin or eyes.
2. Immediately turn off the power, disconnect the AC adaptor and remove the battery if any of the following events are observed in the battery pack: offensive or unusual odor, excessive heat, discoloration or deformation. Never use the computer again until it has been checked by a TOSHIBA service provider. It might generate smoke or fire, or the battery pack might rupture.
3. Make sure the battery is securely installed in the computer before attempting to charge the battery pack. Improper installation could generate smoke or fire, or cause the battery pack to rupture.
4. Keep the battery pack out of reach of infants and children. It can cause injury.

Caution

1. Never continue to use a battery pack after its recharging capacity has become impaired, or after the display of a warning message indicating that the battery pack's power is exhausted. Continued use of an exhausted or impaired battery pack could cause the loss of data.
2. Never dispose of battery packs with normal trash. Bring them to your TOSHIBA dealer or to another recycling center to save resources and prevent environmental damage. Cover the terminals with electrical tape to prevent short-circuits, which could cause the battery pack to ignite or rupture.
3. Use only battery packs recommended by TOSHIBA as replacements.
4. Always make sure the battery pack is installed correctly and securely. Otherwise, a battery pack could fall out and possibly cause injury.
5. Charge the battery pack only in an ambient temperature between 5 and 35 degrees Celsius. Otherwise, the electrolyte solution might leak, battery pack performance might deteriorate and the battery life might be shortened.

6. Be sure to monitor the remaining battery power. If the battery pack and real time clock battery discharge completely, Standby and Suspend will not function and data in memory will be lost. Also, the computer might register an incorrect time and date. In this case, connect the AC adaptor to recharge the batteries.
7. Never install or remove the battery pack without first turning off the power and disconnecting the AC adaptor. Never remove the battery pack while the computer is in Suspend or Standby mode. Data will be lost.

Note

1. Never remove the battery pack while the Wake-up on LAN function is enabled. Data will be lost. Before you remove a battery pack, disable the Wake-up on LAN function.
2. To ensure the battery pack maintains maximum capacity, operate the computer on battery power once a week until the battery pack is fully discharged. Refer to the section *Extending battery life* in this chapter for procedures. If the computer is continuously operated on AC power for an extended period, more than a week, the battery might fail to retain a charge. It might not function efficiently over the expected life of the battery pack and the **Battery** indicator might not indicate a low-battery condition.
3. After the battery pack is charged, avoid leaving the AC adaptor connected and the computer turned off for more than a few hours at a time. Continuing to charge a fully-charged battery pack can damage the battery.

Charging the batteries

When the power in the battery pack becomes low, the **Battery** indicator flashes orange indicating that only a few minutes of battery power remain. If you continue to use the computer while the **Battery** indicator flashes, the computer enables Hibernation mode (so you don't lose data) and automatically turns off.



The computer enters Hibernate mode only if Hibernation is enabled in two places: the Hibernate tab in Power Options and Setup Action tab in TOSHIBA Power Saver.

You must recharge a battery pack when it becomes discharged.

Procedures

To recharge a battery pack while it is installed in the computer, connect the AC adaptor to the **DC IN 15V** socket and plug the other end into a working outlet.

The **Battery** indicator glows orange when the battery is being charged.



Use only the computer connected to an AC power source or the optional TOSHIBA Battery charger to charge the battery pack. Never attempt to charge the battery pack with any other charger.

Time

The following table shows the approximate time required to fully charge a discharged battery.

Charging time (hours)

Battery type	Power on	Power off
High capacity battery pack (8800mAh)	about 10.5 to 21.5	about 4.5
Main battery pack (4400mAh)	about 5.0 to 11.0	about 2.5
2nd battery pack	about 4.5 to 9.5	about 3
RTC battery	8	Doesn't charge



The charging time when the computer is on is affected by ambient temperature, the temperature of the computer and how you use the computer. If you make heavy use of external devices, for example, the battery might scarcely charge at all during operation. Refer also to the section Maximizing battery operating time.

Battery charging notice

The battery may not charge right away under the following conditions:

- The battery is extremely hot or cold. If the battery is extremely hot, it might not charge at all. To ensure the battery charges to its full capacity, charge the battery at room temperature of 10° to 30°C (50° to 88°F).
- The battery is nearly completely discharged. Leave the AC adaptor connected for a few minutes and the battery should begin charging.

The **Battery** indicator may show a rapid decrease in battery operating time when you try to charge a battery under the following conditions:

- The battery has not been used for a long time.
- The battery has completely discharged and been left in the computer for a long time.
- A cool battery is installed in a warm computer.

In such case, follow the steps below.

1. Fully discharge the battery by leaving it in the computer with the power on until the power automatically shuts off.
2. Plug in the AC adaptor.
3. Charge the battery until the **Battery** indicator glows green.

Repeat these steps two or three times until the battery recovers normal capacity.



Leaving the AC adaptor connected will shorten battery life. At least once a month, run the computer on battery power until the battery is fully discharged, then recharge the battery.

Monitoring battery capacity

Remaining battery power can be monitored in TOSHIBA Power Saver.



- *Wait at least 16 seconds after turning on the computer before trying to monitor the remaining operating time. The computer needs this time to check the battery's remaining capacity and to calculate the remaining operating time, based on the current power consumption rate and remaining battery capacity. The actual remaining operating time may differ slightly from the calculated time.*
- *With repeated discharges and recharges, the battery's capacity will gradually decrease. Therefore, an often used, older battery will not operate for as long as a new battery even when both are fully charged. In this case, TOSHIBA Power Saver will indicate a 100% charge for both the old and new battery, but the displayed estimated time remaining will be shorter for the older battery.*

Maximizing battery operating time

A battery's usefulness depends on how long it can supply power on a single charge.

How long the charge lasts in a battery depends on:

- How you configure the computer (for example, whether you enable battery-power saving options). The computer provides a battery save mode, which can be set in TOSHIBA Power Saver, to conserve battery power. This mode has the following options:
 - CPU Processing speed
 - Screen brightness
 - Cooling Method
 - System standby
 - System Hibernation
 - Monitor Power off
 - HDD Power off
- How often and how long you use the hard disk, optical disc and the floppy disk drive.
- How much charge the battery contained to begin with.
- How you use optional devices, such as a PC card, to which the battery supplies power.
- Enabling Standby mode conserves battery power if you are frequently turning the computer off and on.
- Where you store your programs and data.
- Closing the display when you are not using the keyboard saves power.
- Operating time decreases at low temperatures.
- The condition of the battery terminals. Make sure the battery terminals stay clean by wiping them with a clean dry cloth before installing the battery pack.

Retaining data with power off

When you turn off your computer with fully charged batteries, the batteries retain data for the following approximate time periods.

High capacity Battery pack (8800mAh)	about 16 days (Standby mode) about 50 days (Boot mode)
Battery pack (4400mAh)	about 8 days (Standby mode) about 25 days (Boot mode)
2nd Battery pack	about 6 days (Standby mode) about 20 days (Boot mode)
RTC battery	30 days

Extending battery life

To maximize the life of your battery pack:

- At least once a month, disconnect the computer from a power source and operate it on battery power until the battery pack fully discharges. Before doing so, follow the steps below.
 1. Turn off the computer's power.
 2. Disconnect the AC adaptor and turn on the computer's power. If it does not turn on go to step 4.
 3. Operate the computer on battery power for five minutes. If the battery pack has at least five minutes of operating time, continue operating until the battery pack is fully discharged. If the **Battery** indicator flashes or there is some other warning to indicate a low battery, go to step 4.
 4. Connect the AC adaptor to the computer and the power cord to a power outlet. The **DC IN 15V** indicator should glow green, and the Battery indicator should glow orange to indicate that the battery pack is being charged. If the **DC IN 15V** indicator does not glow, power is not being supplied. Check the connections for the AC adaptor and power cord.
 5. Charge the battery pack until the **Battery** indicator glows green.
- If you have extra battery packs, rotate their use.
- If you will not be using the system for an extended period, more than one month, remove the battery pack.
- Disconnect the AC adaptor when the battery is fully charged. Overcharging makes the battery hot and shortens life.
- If you are not going to use the computer for more than eight hours, disconnect the AC adaptor.
- Store spare battery packs in a cool dry place out of direct sunlight.

Replacing the battery pack

When the battery pack reaches the end of its operating life you will need to install a new one. The life of the battery pack is generally about 500 recharges. If the **Battery** indicator or **Slim Select Bay** indicator (if a Slim Select Bay 2nd battery pack is installed) flashes orange shortly after fully recharging the battery, the battery pack needs to be replaced.

You might also replace a discharged battery pack with a charged spare when you are operating your computer away from an AC power source. This section explains how to remove and install the battery pack. For the details about removing/installing the Slim Select Bay 2nd battery pack, refer to Chapter 8, *Optional Devices*.

Removing the battery pack

To replace a discharged battery, follow the steps below.



- *When handling battery packs, do not short-circuit the terminals. Also do not drop, hit or otherwise apply impact; do not scratch or break the casing and do not twist or bend the battery pack.*
- *Do not remove the battery pack while the computer is in Standby mode. Data is stored in RAM, so if the computer loses power it will be lost. In Hibernation mode, data will be lost if you remove the battery or disconnect the AC adaptor before the save is completed. Wait for the **Disk** indicator to go out.*
- *Do not touch the latch while holding the computer. Or you may get injured by the dropped battery by unintentional release of the latch.*

1. Save your work.
2. Turn the computer's power off. Make sure the Power indicator is off.
3. Remove all cables connected to the computer.
4. Turn the computer upside down.

- Slide and hold the battery release latch to free the battery pack for removal after switching the battery safety lock into unlock position (in left direction), then slide out the battery pack.

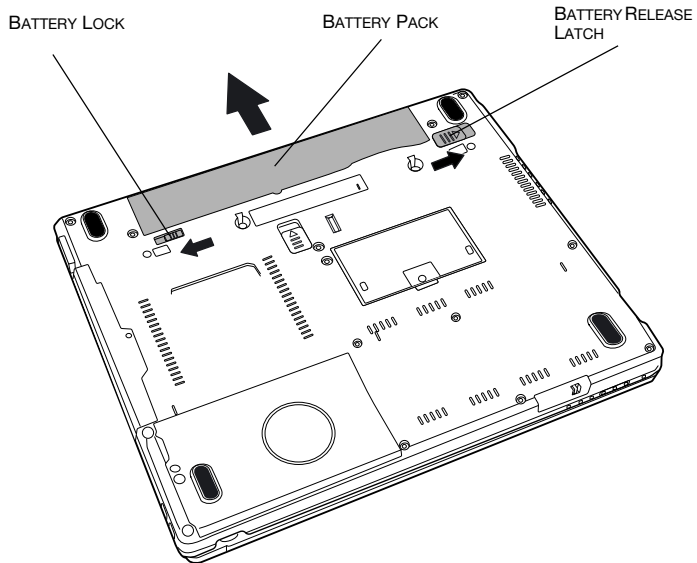

Releasing the battery pack



For environmental reasons, do not throw away a spent battery pack. Please return spent battery packs to your TOSHIBA dealer.

Installing the battery pack

To install a battery, follow the steps below.



- *The battery pack is a lithium ion battery, which can explode if not properly replaced, used, handled or disposed of. Dispose of the battery as required by local ordinances or regulations. Use only batteries recommended by TOSHIBA as replacements.*
- *Do not touch the latch while holding the computer. Or you may get injured by the dropped battery by unintentional release of the latch.*

- Turn the computer's power off.
- Disconnect all cables connected to the computer.
- Insert the battery pack.

4. Secure the battery pack lock. Switch the battery safety lock into lock position.(in right direction)

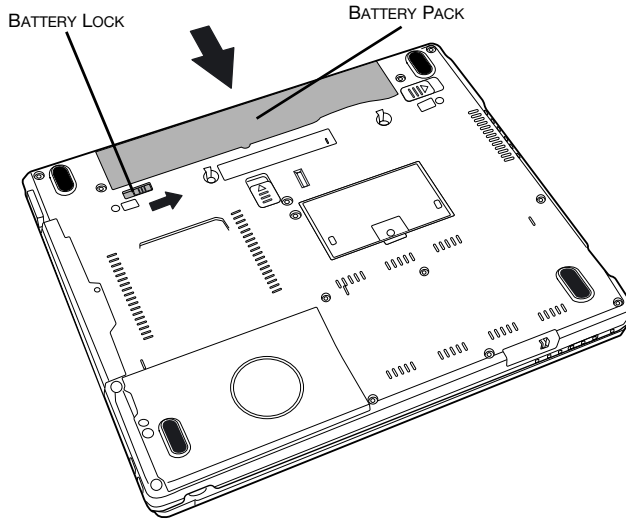

Securing the battery cover

TOSHIBA Password Utility

The TOSHIBA Password Utility provides two levels of password security: User and Supervisor.



Passwords set in TOSHIBA Password Utility are different from the Windows password.

User password

To start the utility, point to or click the following items:

Start -> All Programs -> TOSHIBA -> Utilities -> Password Utility

The user password dialog box contains two main fields: **User Password** and **User Token**.

User Password field

- **Set** (button)

Click this button to register a password of up to 50 characters. After a password is set, you will be prompted to enter it when you start the computer.



After you set the password, a dialog box will be displayed asking whether you want to save it to a diskette or other media. If you forget the password, you can open the password file on another computer. Be sure to keep the media in a safe place.

- **Delete** (button)

Click this button to delete a registered password. Before you can delete a password, you must first enter the current password correctly or insert a proper token.

- **Change** (button)

Click this button to change a registered password. Before you can change a password, you must first enter the current password correctly or insert a proper token.

Owner String (text box)

You can use this box to associate text with the password. After you enter text, click **Apply** or **OK**. At the time of a startup of a computer, this text is displayed, when you can ask for the input of a password.

User Token field

- **Create** (button)

You can use an SD card token, instead of entering the password. After you have registered a password, insert an SD card and click **Create**. You can use an SD card of any capacity, but it must be formatted correctly.

If an unformatted card or one with an incompatible format is inserted, you will be prompted to format it with a tool named TOSHIBA SD Memory Card Format. To start the format tool, point to or click the following items:

Start -> All Programs -> TOSHIBA -> Utilities -> SD Memory Card Format



When you format an SD Memory card, all data will be deleted. Be sure to save data on the card to other media before you format the card.

- **Disable** (button)

Click this button to invalidate the token. You cannot revalidate old tokens, but you can use the same SD cards to create new tokens.

Supervisor password

If you set a supervisor password, some functions might be restricted when a user logs on with the user password. To set a supervisor password, execute the file TOSUP.EXE. The file is located at:

`C:\Program Files\Toshiba\Windows Utilities\SVPWTool\TOSUP.EXE`

This utility lets you do the following:

- Register, delete or change the supervisor password.
- Create or invalidate a supervisor password token



This function in the TOSHIBA Password Utility lets you invalidate only supervisor tokens or all tokens, including user and supervisor tokens.

- Specify restrictions for general users.

Starting the computer by password

If you registered a password, there are two ways to start the computer:

- Insert a token before you turn on the computer. The computer will start normally, without displaying a password prompt.
- Enter the password manually.



The password is necessary only if the computer was shut down in boot mode. It is not needed in Hibernation or Standby mode.

To enter a password manually, follow these steps:

1. Turn on the power as described in Chapter 3, *Getting Started*. The following message will appear in the LCD:



Password=

2. Enter the Password.
3. Press Enter.



If you enter the password incorrectly three times in a row, the computer shuts off. In this case, you must turn the computer back on to retry password entry.

Power-up modes

The computer has the following power-up modes:

- **Boot:** Computer shuts down without saving data. Always save your work before you turn the computer off in boot mode.
- **Hibernation:** Data in memory is saved to the hard disk.
- **Standby:** Data is maintained in the computer's main memory.



Refer also to the sections Turning on the power and Turning off the power in Chapter 3, Getting Started.

Windows utilities

You can specify the setting in TOSHIBA Power Saver.

Hot keys

You can use hot keys **Fn + F3** to enter Standby mode and **Fn + F4** to enter Hibernation. See Chapter 5, *The Keyboard* for details.

Panel power on/off

You can set up your computer so that power turns off automatically when you close the display panel. When you open the panel, power turns on in Standby or Hibernation mode but not in boot mode.



If the panel power off function is enabled and you use Shut down Windows, do not close the display until the shut down function is completed.

System Auto Off

This feature turns the system off automatically if it is not used for a set duration. The system shuts down in Standby mode or Hibernation mode in Windows.

Chapter 7

HW Setup

This chapter explains how to use the TOSHIBA HW Setup program to configure your computer. TOSHIBA HW Setup lets you configure settings for Display, CPU, Boot Priority, Keyboard, USB, LAN, General, Device Config and Parallel/Printer.



Some models are not equipped with Parallel/Printer tab and/or CPU tab.

Accessing HW Setup

To run HW Setup, click **start**, click **Control Panel**, click **Printers and Other Hardware** and select **TOSHIBA HW Setup**.

HW Setup window

The HW Setup window contains the following tabs: General, Device Config, Parallel/Printer, Display, CPU, Boot Priority, Keyboard, USB and LAN.

There are also three buttons: OK, Cancel and Apply.

OK	Accepts your changes and closes the HW Setup window.
Cancel	Closes the window without accepting your changes.
Apply	Accepts all your changes without closing the HW Setup window.

General

This window displays the BIOS version and contains two buttons: **Default** and **About**.

Default	Return all HW Setup values to the factory settings.
About	Display the HW Setup version.

Setup

This field displays BIOS version and date.

Device Config

Device Configuration

This option lets you set the device configuration.

All Devices	BIOS sets all devices.
Setup by OS	Operating system sets devices that it can control. (Default)

Parallel/Printer

Some models are equipped with Parallel/Printer tab. This tab lets you set the Parallel Port Mode. Use the Windows Device Manager to make settings for the Parallel port.

Parallel Port Mode

The options in this tab are ECP and Standard Bi-directional.

ECP	Sets the port type to Extended Capabilities Port (ECP). For most printers, the port should be set to ECP. (Default)
Standard Bi-directional	This setting should be used with some other parallel devices.

Display

This tab lets you customize your computer's display settings for either the internal LCD screen or for an external monitor.

Power On Display

Lets you use the display to be used when the computer is booted. (This setting is only available on Standard VGA mode and not available on Windows Desktop)

Auto-Selected	Selects an external monitor if one is connected. Otherwise, it selects the internal LCD. (Default)
LCD + Analog RGB	Selects both the internal LCD and external monitor for simultaneous display.

CPU

This function lets you set the CPU operating mode.

Dynamic CPU Frequency Mode

This option lets you choose from the following settings:

Dynamically Switchable	CPU power consumption and clock speed automatic switching function is enabled. When the computer is in use, CPU operation is automatically switched when necessary. (Default)
Always High	CPU power consumption and clock speed automatic switching function is disabled. The CPU always runs at its fastest speed.
Always Low	CPU power consumption and clock speed automatic switching function is disabled. The CPU always runs at low power consumption and low speed.

Boot Priority

Boot Priority Options

This option sets the priority for booting the computer. Select from the following settings:

HDD → FDD → CD-ROM → LAN	The computer looks for bootable files in the following order: HDD, floppy disk drive* ¹ , CD-ROM* ² and LAN. (Default)
FDD → HDD → CD-ROM → LAN	The computer looks for bootable files in the following order: floppy disk drive* ¹ , HDD, CD-ROM* ² and LAN.
HDD → CD-ROM → LAN → FDD	The computer looks for bootable files in the following order: HDD, CD-ROM* ² , LAN and floppy disk drive* ¹ .
FDD → CD-ROM → LAN → HDD	The computer looks for bootable files in the following order: floppy disk drive* ¹ , CD-ROM* ² , LAN and HDD.
CD-ROM → LAN → HDD → FDD	The computer looks for bootable files in the following order: CD-ROM* ² , LAN, HDD, floppy disk drive* ¹ .
CD-ROM → LAN → FDD → HDD	The computer looks for bootable files in the following order: CD-ROM* ² , LAN, floppy disk drive* ¹ and HDD.

You can override the settings and manually select a boot device by pressing one of the following keys while the computer is booting:

U	Selects the USB floppy disk drive.
N	Selects the Network.
1	Selects the primary HDD.
2	Selects the secondary HDD.
P	Selects the PC card HDD.
C	Selects the CD-ROM* ² .

*¹ FDD is looked for when the boot disk is contained in external FDD. When SD memory card is set as the boot disk, external FDD is looked for first. Next, SD memory card is looked for.

*² In this computer, CD-ROM refers to the Slim Select Bay optical media drive.



- *PC card HDD boot is supported only by slot 0 on the computer. Support is guaranteed only for TOSHIBA PC card HDDs.*
- *When you assign a PC card HDD top priority, "PC" is not displayed. However, the PC card HDD takes the position of HDD in the Boot Priority Options list above.*

To change the boot drive, follow the steps below.

1. Hold down **F12** and boot the computer.
2. The following menu will be displayed with the following icons: Built-in HDD, Slim Select Bay HDD, CD-ROM, FDD (or SD memory card), Network (LAN), PC (ATA) card boot.



A bar will appear only under the selected device.

3. Use the left/right cursor keys to highlight the boot device you want and press **Enter**.



- *If a supervisor password is set, the menu above does not appear when you use the user password to start the computer.*
- *The selection method above does not change the boot priority settings in HW Setup.*
- *If you press a key other than one of those above or if the selected device is not installed, the system will boot according to the current setting in HW Setup.*
- *Support of PC (ATA) card boot is guaranteed only for TOSHIBA PC card HDDs*
- *A PC (ATA) card takes the position of HDD in the Boot Priority Options list.*

HDD Priority Options

If more than one HDD is installed in the computer, this option lets you set the priority for HDD detection. If the first detected HDD has a boot command, the system will boot from the HDD.

Built-in HDD -> 2nd HDD -> PC Card (Default)	The computer will look for the Built-in HDD first, next the 2nd HDD and then the PC Card (Default).
2nd HDD -> Built-in HDD -> PC Card	The computer will look for the 2nd HDD first, next the Built-in HDD and then the PC Card.
Built-in HDD -> PC Card -> 2nd HDD	The computer will look for the Built-in HDD first, next PC Card and then the 2nd HDD.
2nd HDD -> PC Card -> Built-in HDD	The computer will look for the 2nd HDD first, next the PC Card and then the Built-in HDD.
PC Card -> Built-in HDD -> 2nd HDD	The computer will look for the PC Card first, next the Built-in HDD and then the 2nd HDD.
PC Card -> 2nd HDD -> Built-in HDD	The computer will look for the PC Card first, next the 2nd HDD and then the Built-in HDD.



If a boot command is not found on the first detected HDD, the system will not boot from the other HDD. It will search the next device in the boot priority for a boot command.

Network Boot Protocol

This feature sets the protocol to remotely boot from the network.

[PXE] Sets PXE as the protocol. (Default)

[RPL] Sets RPL as the protocol.



- PC card HDD boot is supported only by the PC card slot on the computer. Support is guaranteed only for TOSHIBA PC card HDDs.
- When you assign a PC card HDD top priority, "PC" is not displayed. However, the PC card HDD takes the position of HDD in the Boot Priority Options list above.
- Some modules may not be displayed.

Keyboard

External Keyboard Fn key

Use this option to set a key combination on an external keyboard to emulate the **Fn** key on the computer's internal keyboard. Setting an **Fn** key equivalent will let you use Hot keys by pressing the set combination instead of the **Fn** key. (PS/2 keyboard only)

Disabled	No Fn key equivalent (Default)	
Fn Equivalent	Left Ctrl	+ Left Alt
	Right Ctrl	+ Right Alt
	Left Alt	+ Left Shift
	Right Alt	+ Right Shift
	Left Alt	+ Caps Lock



If you select **Left Ctrl + Left Alt** or **Right Ctrl + Right Alt** for this option, you cannot use the selected keys to reboot the computer in combination with the **Del** key. For example, if you select **Left Ctrl + Left Alt**, you must use **Right Ctrl**, **Right Alt** and **Del** to reboot the computer. **Left Ctrl**, **Left Alt** and **Del** cannot be used.

Wake-up on Keyboard

When this feature is enabled and the computer is in Standby mode, you can turn on the computer by pressing any key. It is effective only for the internal keyboard and only when the computer is in standby mode.

Enabled	Enables the Wake-up on Keyboard.
Disabled	Disables the Wake-up on Keyboard. (Default)

LAN

Wake-up on LAN

This feature lets the computer's power be turned on when it receives a wake-up signal from the LAN.

Enabled	Enables Wake-up on LAN.
Disabled	Disables Wake-up on LAN. (Default)



Do not install or remove an optional memory module while Wake-up on LAN is enabled.



The Wake-up on LAN function consumes power even when the system is off. Leave the AC adaptor connected while using this feature.

Built-in LAN

This feature enables or disables the Built-in LAN.

Enabled	Enables Built-in LAN functions. (Default)
Disabled	Disables Built-in LAN functions.

USB

USB KB/Mouse Legacy Emulation

Use this option to enable or disable USB KB/Mouse Legacy Emulation. If your operating system does not support USB, you can still use a USB mouse and keyboard by setting the **USB KB/Mouse Legacy Emulation** item to **Enabled**.

Enabled	Enables the USB KB/Mouse Legacy Emulation. (Default)
Disabled	Disables the USB KB/Mouse Legacy Emulation.

USB-FDD Legacy Emulation

Use this option to enable or disable USB-FDD Legacy Emulation.

Enabled	Enables the USB-FDD Legacy Emulation. (Default)
Disabled	Disables the USB-FDD Legacy Emulation.

However, the USB port 3 does not support USB KB/Mouse and USB-FDD Legacy Emulation.

Optional Devices

Optional devices can expand the computer's capabilities and its versatility. This chapter describes connection or installation of the following devices, which are available from your TOSHIBA dealer:

Cards/memory

- PC cards
- SD cards
- Memory expansion

Power devices

- Additional battery pack
- High capacity battery pack
- Slim Select Bay 2nd battery pack
- Additional AC adaptor
- Battery charger

Peripheral devices

- Slim Select Bay HDD adaptor
- External monitor
- TV
- i.LINK (IEEE1394)

Docking

- Advanced Port Replicator III

Other

- Security lock

PC cards

The computer is equipped with a PC card expansion slot that can accommodate one 5 mm Type II card. Any PC card that meets industry standards (manufactured by TOSHIBA or other vendor) can be installed. The slot supports 16-bit PC cards, including PC card 16's multifunction card and CardBus PC cards.

CardBus supports the new standard of 32-bit PC cards. The bus provides superior performance for the greater demands of multimedia data transmission.

Inserting a PC card

The PC card connector is located on the left side of the computer.

Windows' hot-install feature lets you insert PC cards while the computer's power is on.



- *Do not insert a PC card while the computer is in standby or hibernation mode. Some cards might not work properly.*
- *An HDD or CD-ROM connected to a 16-bit PC card, might affect the performance of the computer's sound system and data transmission, including slower transmission speeds and dialing errors.*

To insert a PC card, follow the steps below:

1. Insert the PC card.
2. Press gently to ensure a firm connection.

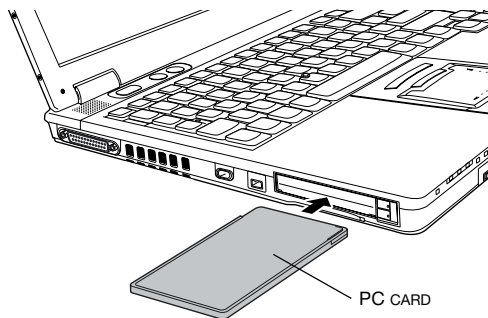

Inserting the PC card

After inserting the card, refer to the card's documentation and check the configuration in Windows to make sure it is appropriate for your card.

Removing a PC card

To remove the PC card, follow the steps below.

1. Open the **Safety Remove Hardware** icon on the system tray and disable the PC card.
2. Press the PC card eject button to extend it.
3. Press the extended eject button to pop the card out slightly.
4. Pinch the PC card and draw it out.

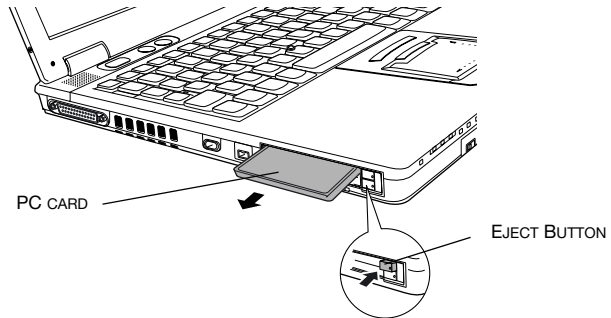

Removing the PC card

SD cards

The computer is equipped with an SD card slot that can accommodate Secure Digital flash memory cards with various memory capacities. SD cards let you easily transfer data from devices, such as digital cameras and Personal Digital Assistants, that use SD card flash-memory. The cards have a high level of security and copy protection features. The slot cannot accommodate Multi Media cards.



Keep foreign objects out of the SD card slot. A pin or similar object can damage the computer's circuitry.



SD memory cards comply with SDMI (Secure Digital Music Initiative), which is a technology adopted to prevent unlawful copy or playback of digital music. For this reason, you cannot copy or playback protected material on another computer or other device. You may not use the reproduction of any copyrighted material except for your personal enjoyment.

Formatting an SD card

SD memory cards are sold with format in conformity to the Standards of SD memory card. If you format the SD card again, be sure to format it with the utility of TOSHIBA SD memory card format, not in the format defined as the Windows standard format.

In order to run TOSHIBA SD memory card format, click windows start button, point to All Programs, point to TOSHIBA, point to Utilities and click SD memory card Format.

TOSHIBA SD memory card format does not format the protected area of SD memory card. When you format all area of the SD memory card including the protected area, use the application that responds to the copy protection system.

Installing an SD card

To insert an SD card, follow the steps below.

1. Insert the SD card.
2. Press gently to ensure a firm connection.

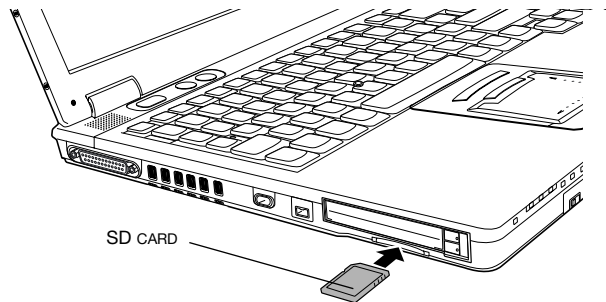

Inserting an SD card



Make sure the SD card is oriented properly before you insert it.

Removing an SD card

To remove an SD card, follow the steps below.

1. Open the **Safely Remove Hardware** icon on the system tray and disable the SD card.
2. Push in the card and release it to pop the card out slightly.

3. Grasp the card and remove it.

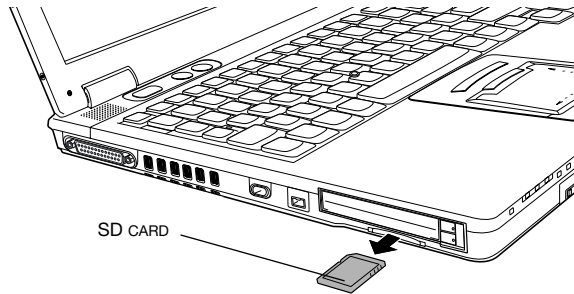

Removing an SD card



- Make sure the **SD card** indicator is out before you remove the card or turn off the computer's power. If you remove the card or turn off the power while the computer is accessing the card you may lose data or damage the card.
- Do not remove an SD card while the computer is in Standby or Hibernation mode. The computer could become unstable or data in the SD card could be lost.

SD card care



Set the write-protect switch to the lock position, if you do not want to record data.

1. Do not write to an SD card if the battery power is low. Low power could affect writing accuracy.
2. Do not remove an SD card while read/write is in progress.
3. The SD card is designed so that it can be inserted only one way. Do not try to force the card into the slot.
4. Do not leave an SD card partially inserted in the slot. Press the SD card until you hear it click into place.
5. Do not twist or bend SD cards.
6. Do not expose SD cards to liquids or store in humid areas or lay media close to containers of liquid.
7. After using an SD card, return it to its case.
8. Do not touch the metal part or expose it to liquids or let it get dirty.

Creation of a boot disk

In TOSHIBA SD Memory Boot Utility, a boot disk can be created with SD memory card. Refer to the *Utilities* section in Chapter 1, Introduction, for details.

Memory expansion

This computer is equipped with two memory module sockets; Slot A is beneath the keyboard and Slot B is on the underside of the computer. You can increase the amount of RAM to 2048 MB by installing an additional memory or replacing default memories with additional memories.



- *Observe the following instructions according to the model you purchased.*
 - a. *Install an additional memory module to Slot B for the computer with vacant Slot B.*
 - b. *You can increase the memory amount by replacing the memory module in Slot A and/or B with a memory module of larger memory amount when both Slot A and Slot B are occupied. However, replacing of memory module in Slot B is recommended because it is easier to replace the memory module in Slot B than A.*
 - c. *It is strongly recommended to leave the replacing of memory module preinstalled in Slot A to TOSHIBA dealer because the installing or replacing of memory module in Slot A needs skill.*
- *Place a mat beneath the computer to prevent making a scratch on the lid when replacing the memory module. Avoid the mat that generates static electricity.*
- *When you remove a memory, please do not touch other portions of the computer.*



- *Use only memory modules approved by TOSHIBA.*
- *Do not try to install or remove a memory module under the following conditions. You can damage the computer and the module. Also, data will be lost.*
 - a. *The computer is turned on.*
 - b. *The computer was shut down using the Standby mode or Hibernation mode.*
 - c. *Wake-up on LAN is enabled.*

If you install a memory module that is not compatible with the computer, beep will sound when you turn on the power. If the module is installed in slot A, there will be a long beep (1 second) followed by two short beeps (0.5 second each). If the memory module is in slot B, there will be a long beep followed by four short beeps. If the both memory modules in slot A and slot B are incompatible, there will be a long beep followed by two short beeps and after a pause (1 second) a long beep followed by four short beeps. In this case, shut down the power and remove the incompatible module(s).



Be sure to install memory module to Slot A. The computer does not boot when Slot A is vacant.



Use a 0-bit, Phillips screwdriver to remove and fasten screws. Use of an incorrect screwdriver can damage the screw heads.

Installing memory module (Main memory)

To install a memory module, make sure the computer is in boot mode then:

1. Turn the computer off in boot mode. Refer to the *Turning off the power* section in Chapter 3, *Getting Started*.
2. Remove all cables connected to the computer.
3. Turn the computer upside down and remove the battery pack (refer to Chapter 6, *Power and Power-Up Modes*.)
4. Remove the screw that becomes visible when the battery pack is removed and turn the computer right side up.

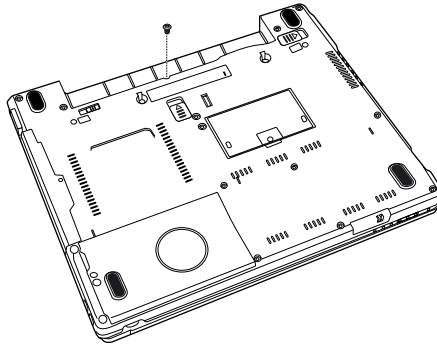

Removing the screw

5. Slide the display latch on the front of the computer to the right and open the display panel.
6. Insert a thin object under the rim of the keyboard brace and lift out the brace.



Remove a keyboard brace after surely performing step 4. If step 4 is not performed, there is a possibility of damaging a keyboard brace.

7. Remove two screws securing the keyboard.

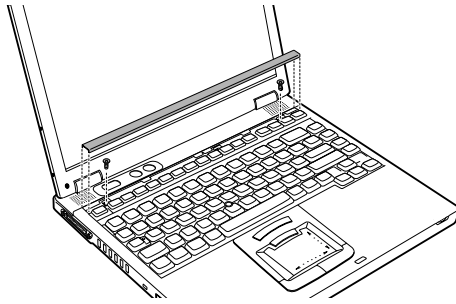

Removing the keyboard brace, removing two screws and rotate the keyboard



Use a point size 0 Phillips screwdriver.

8. Lift up the back of the keyboard, rotate it toward you and lay in face down on the palm rest.



- When you move the keyboard forward, do not touch the keys. Doing so could cause misalignment. Hold the keyboard by the sides and lay it gently on the palm rest.
- The keyboard is connected to the computer by a ribbon cable. Be careful not to apply tension to this cable when you lift up the keyboard. Do not try to disconnect this cable.

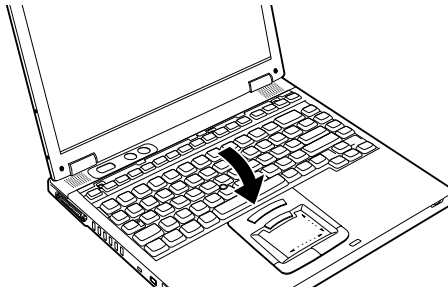

Rotate the keyboard

9. One screw of Metal brace which is pressing down the keyboard cable is removed. Metal brace is removed.

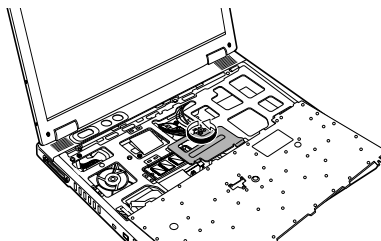

Removing the metal brace



Do not touch the connectors on the memory module or on the computer. Debris on the connectors may cause memory access problems.

10. Insert a new module in the socket and push it down so it lies flat and is secured by two latches on either side.

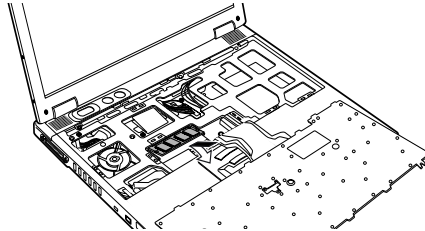

Installing the memory module

11. The keyboard cable is pressed down with Metal brace and one screw secures the metal brace.
12. Insert tabs on the front of the keyboard into corresponding notches on the computer and seat the keyboard.



When seating the keyboard, be sure to fit the flexible printed circuit board under the palm rest if the flat cable was pulled out while you were removing the keyboard.

13. Two screws secure the keyboard.



Be sure to use all two screws removed in step 7. Make sure no screw was dropped into the computer. Make sure all foreign matter, such as the tape applied in step 10 is removed.

14. Seat the keyboard brace and press to secure latches.
15. Install the battery pack. Refer to *Replacing the battery pack* section in Chapter 6, Power and Power-up Modes, for details.
16. Turn the power on and make sure the added memory is recognized. Open System Properties in the Control Panel and click the General tab.

Removing memory module (Main memory)

To remove the memory module, make sure the computer is in boot mode then:

1. Turn the computer off and remove all cables connected to the computer.
2. Turn the computer upside down and remove the battery pack (refer to Chapter 6, *Power and Power-up Modes*.)
3. Follow steps 4 through 9 in Installing memory module to access the memory module.
4. Push the latches to the outside to release the module. A spring will force one end of the module up.
5. Grasp the sides of the module and pull it out, then replace the insulator.



- *If you use the computer for a long time, the memory modules and the circuits locating close to the memory modules will become hot. In this case, let them cool to room temperature before you replace them. Or you will get burnt if you touch any of them.*
- *Do not touch the connectors on the memory module or on the computer. Debris on the connectors may cause memory access problems.*

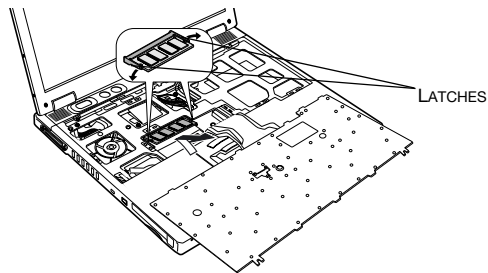

Removing the memory module

6. Rotate the keyboard back into place and secure the keyboard brace as described in the previous section.
7. Turn the computer upside down and replace the battery pack.

Installing memory module (2nd memory)

Follow the steps below to install a memory module.

1. Save data, shutdown Windows and turn the power off.
2. Remove the AC adapter cable and other cables from the computer.
3. Close the display panel and turn the computer over. Remove the battery pack.
4. Loosen a screw on the cover of the memory module slot.

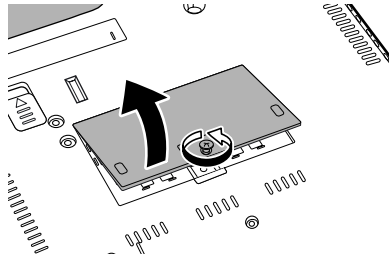

Removing the memory module cover

5. Insert the memory module obliquely against the connector of the memory module slot. Gently push the memory module until it is secured in place.



- *Align the grooves of the memory module with the locking tabs of the connector and insert the module into the connector firmly. If you find it difficult to install the memory module, try to adjust the tabs of the connector with a pen tip or other tools. Make sure to hold the memory module with your fingers on the side edges (sides with grooves).*

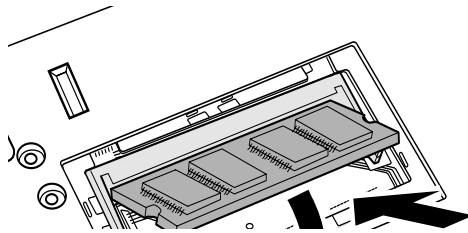

Installing a module

6. Reinstall the cover of the memory module slot. Fasten the screw you loosened in Step 4.



- *Be sure that the cover is closed firmly.*

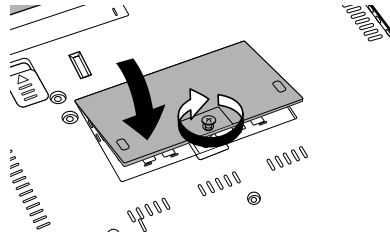

Seating the memory module cover

7. Reinstall the battery pack.



After installing a memory module, turn the power of the computer on to see a total memory size. The system will calculate the total memory size.

Removing memory module (2nd memory)

To remove the memory module, make sure the computer is in boot mode then:

1. Save data, shutdown Windows and turn the power off.
2. Remove the AC adapter cable and other cables from the computer.
3. Close the display panel and turn the computer over. Remove the Battery Pack.
4. Loosen a screw on the cover of the memory module slot.
5. Push slightly outwards the latch tabs on both sides that secure the memory module with a pen tip or other tools, and remove the memory module.



When the memory module rises obliquely, you can remove it from the slot.

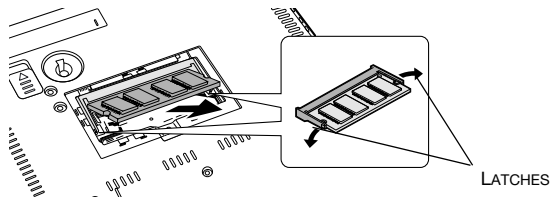

Removing the memory module

6. Reinstall the cover of the memory module slot. Fasten the screw you loosened in Step 4.
7. Reinstall the battery pack.



After installing a memory module, turn the power of the computer on to see a total memory size. The system will calculate the total memory size.

Hard disk drive pack

An extra HDD expands the flexibility of your system and lets you carry your data without carrying the computer.



Use a point size 0 Phillips screwdriver.

Removing the HDD pack

To remove the HDD pack, follow the steps below and refer to figures below.

1. Set the computer to boot mode and turn off the power.
2. Disconnect the AC adaptor and all external cables connected to the computer.
3. Remove the main battery and optional secondary battery when it is used.
4. Turn the computer upside down and remove one screw securing the HDD cover.
5. A small row of ridges mark latches securing the cover. Press on these ridges until you hear a click.
6. Press on the arrows and lift the cover up and out to remove it.

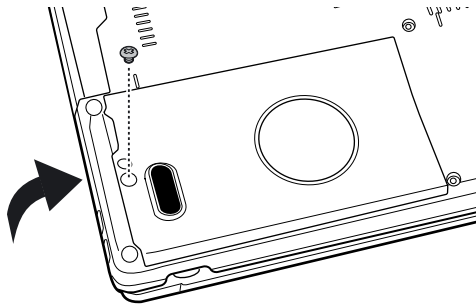

Removing the HDD pack cover

7. Raise the HDD's plastic tab, pinch it and slide the HDD pack to disconnect from the connector.



Be sure to slide the HDD pack first and confirm that the HDD pack has disconnected.

- Lift the HDD pack and remove it.

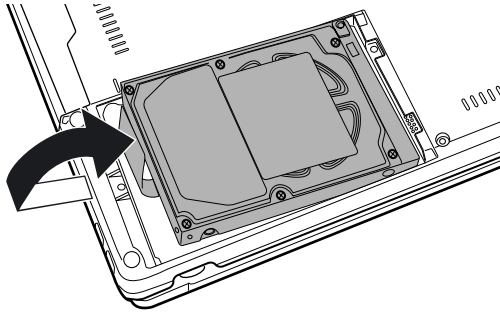

Removing the HDD pack

Installing the HDD pack

To install the hard disk drive, follow the steps below.

- Place the HDD into the space for HDD. Slide the HDD to connect to the connector.
- Fold over the plastic tab so that it goes into the HDD space. Press the HDD to ensure a firm connection.

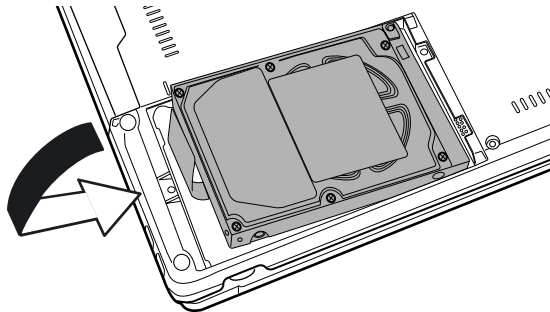

Installing the HDD pack

- Seat the cover and press down until the latches click into place.
- Secure the cover with a screw.

Additional battery pack

You can increase the portability of the computer with additional battery packs. If you're away from an AC power source and your battery runs low, you can replace it with a freshly charged battery. See Chapter 6, *Power and Power-Up Modes*.

High capacity battery pack

You can increase the portability of the computer with a high capacity battery pack. See Chapter 6, *Power and Power-Up Modes*.

Slim Select Bay 2nd battery pack

You can insert a 2nd battery pack in the computer's Slim Select Bay. The battery comes with an adaptor. For details on using the adaptor, follow the steps below. For details on inserting modules in the Slim Select Bay, refer to Chapter 4, *Operating Basics*.

Installing

To install the 2nd battery pack in the adaptor, follow the steps below.

1. Fit the side of the 2nd battery pack opposite the connector into the adaptor.
2. Lay the battery into the adaptor. The latch should close automatically to secure the 2nd battery pack.

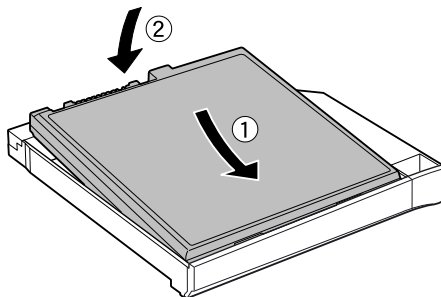

Inserting the secondary battery pack in the adaptor

Removing

To remove the 2nd battery from the adaptor, follow the steps below.

1. Slide the latch in the direction of the arrow shown below.
2. Push the 2nd battery pack up from the bottom and lift it out.

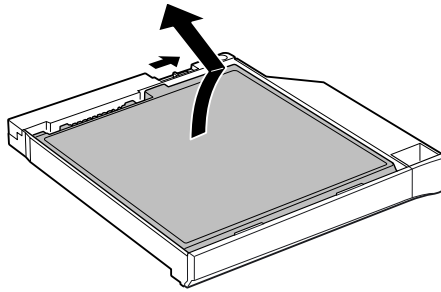

Removing the 2nd battery pack from the adaptor

Additional AC adaptor

If you frequently transport the computer between different sites such as your home and office, purchasing an AC adaptor for each location will reduce the weight and bulk of your carrying load.

Battery charger

The battery charger provides a convenient way to charge battery packs without requiring the use of your computer. The battery charger holds up to two lithium ion battery packs.

Slim Select Bay HDD adaptor

You can increase your computer's data storage capacity by installing an additional 30 GB (27.94 billion bytes), 40 GB (37.26 billion bytes), 60 GB (55.89 billion bytes), or 80 GB (74.51 billion bytes) hard disk drive in the Slim Select Bay.

To install an HDD in the Slim Select Bay HDD adaptor follow the steps below.

1. Slide the lock to the unlock position and open the lid.

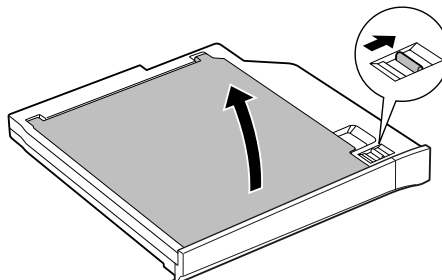

Opening the lid

2. Insert the HDD and push forward to ensure a firm connection.

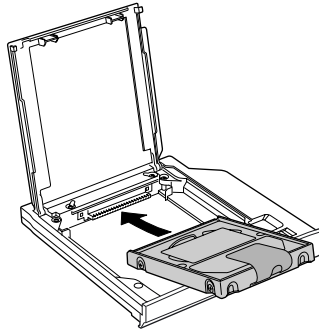

Inserting the HDD

3. Close the lid and slide the lock to the lock position.

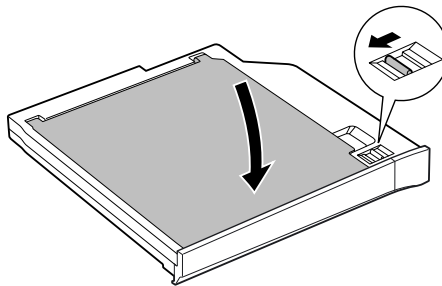

Closing the lid

For details on inserting the Slim Select Bay HDD adaptor in the Slim Select Bay, refer to Chapter 4, *Operating Basics*.

External monitor

An external analog monitor can be connected to the external monitor port on the computer. The computer supports VGA and Super VGA video modes. To connect a monitor, follow the steps below.

1. Turn the computer off.
2. Connect the monitor to the external monitor port.
3. Turn the monitor's power on.
4. Turn the computer on.

When you turn on the power, the computer automatically recognizes the monitor and determines whether it is color or monochrome.

To change the display settings, press **Fn + F5**. If you disconnect the monitor before you turn the computer off, be sure to press **Fn + F5** to switch to the internal display. Refer to Chapter 5, *The Keyboard*, for details on using hot keys to change the display setting.

TV

You can connect a television set to the Video out jack on the computer. Follow the steps below.

Using the TOSHIBA Console button

1. Connect the TV adaptor cable's S-Video plug to the Video out jack on the computer.
2. Connect the TV adaptor cable's S-Video plug to the S-Video jack on the TV.
3. Press the TOSHIBA Console button.

You can use the hot keys **Fn + F5** to change the display device. Refer to Chapter 5, *The Keyboard*.

When changing to "TV OUT" by "TOSHIBA Console button", it is "TOSHIBA controls" and it is necessary to set "TV OUT" as "TOSHIBA Console button" beforehand.



If a television is connected to the computer, set the TV type in Display Properties. Follow the steps below.

- Click **start** and click **Control Panel**.
- Double-click the **Display** icon to open the Display Properties window.
- Click the **Settings** tab and click the **Advanced** button.
- Click the **GeForce FX Go5200 32M/64M** tab, click **Device Settings** and click **Select Output Device**.
- Select **Advanced** and select **TV** in the Device Selection window.
- Select the **Format** box and select the format that your TV supports.

Changing the resolution

If you want to change the resolution, follow the steps below.

1. Open **Display properties** and select the **Settings** tab.
2. Select **Advanced**.
3. Select the **Adapter** tab, then select **List all modes**.
4. Select a resolution from the menu.

Displaying movies on a TV or CRT

This section describes how to set up your system to display movies simultaneously on your computer's internal LCD and on an external TV or CRT monitor.

Follow the steps below.

1. Open the **Control Panel** and click **Appearance and Themes**.
2. Click **Display**.
3. Select the **Settings** tab and click **Advanced button**.

4. Select the GeForce FX Go5200 30M/64M tab.
 - a. Click the **GeForce FX Go5200 32M/64M** button.
 - b. Click **Overlay Controls** in the small menu.
 - c. From the **Full Screen Device** drop down menu, select **Primary Device** or **Secondary Device** to enable movie display on an external TV or CRT monitor.

Primary Device: Movies will be displayed full screen on the computer's internal LCD and in a window on the TV or CRT monitor.

Secondary Device: Movies will be displayed full screen on the TV or CRT monitor and in a window on the computer's internal LCD.

Disable: Movies will not be displayed on a TV or CRT monitor.
 - d. Click **OK**.
 - e. Click **OK** in the **Display Properties** screen.

i.LINK (IEEE1394)

Some models are equipped with an i.LINK port.

i.LINK (IEEE1394) is used for high-speed data transfer for a range of compatible devices such as

- Digital video cameras
- Hard disk drives
- MO drives
- CD-RW drives



i.LINK uses a four-pin connector, which does not carry electric current. External devices will need their own power supply.

Precautions

- Make a back-up of your data before transferring it to the computer. There is a possibility that the original data will be damaged. There is a particular risk that some frames will be deleted in the case of digital video transfer. TOSHIBA assumes no liability for such loss of data.
- Do not transfer data in areas where static electricity is easily generated or in areas subjected to electronic noise. Data can be destroyed.
- If you are transferring data through an IEEE1394 hub, do not connect or disconnect other devices from the hub during data transfer. There is a likelihood that data will be damaged. Connect all devices to the hub before you turn on the computer's power.
- You may not use any copyrighted video or music data copied from a video camera except for your personal enjoyment.

- If you connect/disconnect an i.LINK device to/from another i.LINK device that is currently exchanging data with the computer, data frames might be dropped.
- Make sure data transfer has ended or turn off the computer, before you:
 - Connect/disconnect an i.LINK device to/from the computer.
 - Connect/disconnect an i.LINK device to/from another i.LINK device that is connected to the computer.

Connecting

1. Make sure the connectors are properly aligned and plug the i.LINK (IEEE1394) cable into the computer.
2. Plug the other end of the cable into the device.

Note the following when you use i.LINK:

- You may need to install drivers for your i.LINK devices.
- Not all i.LINK devices have been tested. Therefore, compatibility with all i.LINK devices cannot be guaranteed.
- Use S100, S200 or S400 cables no longer than three meters.
- Some devices might not support standby or automatic off functions.
- Do not connect or disconnect an i.LINK device while it is using an application or when the computer is automatically shutting it down to save power. Data might be destroyed.
- When multiple IEEE1394 devices are connected to a PC, the devices may not correctly be identified. This problem may occur when Windows(r) XP is restarted while the devices are connected or when the power to the IEEE1394 devices is turned on before the PC is turned on. If it occurs, disconnect the IEEE1394 cables and then reconnect them.

Disconnecting

1. Open the **Safety Remove Hardware** icon on the Task Bar.
2. Point to **i.LINK (IEEE1394) device** and click.
3. Disconnect the cable from the computer then from the i.LINK device.



Refer also to the documentation that came with your i.LINK device.

Advanced Port Replicator III

In addition to the ports available on the computer, the Advanced Port Replicator III provides a Serial port and separate ports for PS/2 mouse and PS/2 keyboard. The Port Replicator connects directly to the docking interface on the bottom of the computer. The AC adaptor connects the Port Replicator to a power source.



The computer must be configured properly before connecting to a LAN. Logging onto a LAN using the computer's default settings could cause a malfunction in LAN operation. Check with your LAN administrator regarding set-up procedures.



You must connect the AC adaptor before you connect to a Advanced Port Replicator III.

If DVI and CRT are connected simultaneously, priority is given to the DVI port over CRT.

The following ports and accessories are available on the Advanced Port Replicator III.

- RJ45 LAN jack
- RJ11 Modem jack
- External monitor port
- Parallel port
- Serial port
- PS/2 mouse port
- PS/2 keyboard port
- DC IN 15V socket
- Security lock slot
- Audio line-in, line-out jacks
- Universal Serial Bus (four)
- IEEE 1394 port
- DVI port

Parallel printer

You can connect any standard Centronics-compatible parallel printer to your computer. All you need is an IBM PC parallel printer cable. Your dealer can supply one or you can purchase one at most computer stores.

The cable's connectors are designed so that it is impossible for you to connect them incorrectly. You can also connect a parallel printer to an optional Advanced Port Replicator III. To connect a printer, follow these steps:

1. Turn off the computer.
2. Insert one end of the cable into the computer's parallel port.
3. Tighten the screws that fasten the cable connector to the computer's parallel port.
4. Insert the other end of the cable into the printer's parallel connector.
5. Fasten the connector to the printer with the clips on the parallel port.
6. Turn on the printer.
7. Turn on the computer.
8. Start the HW Setup program. Refer to Chapter 7, *HW Setup*.
9. Select the **Parallel/Printer** tab from the **HW Setup** window.
10. Set the mode to **ECP** and press **OK**.
11. Choose **Reboot** for the change to take effect.

Security lock

Security locks enable you to anchor your computer and optional Advanced Port Replicator III to a desk or other heavy object to help prevent unauthorized removal of the computer or Advanced Port Replicator III.

The computer has a security lock slot on the left side. Attach one end of a cable to a desk and the other end to the security lock slot.

1. Turn the computer so the right side faces you.
2. Align the holes for the security lock and attach the lock.

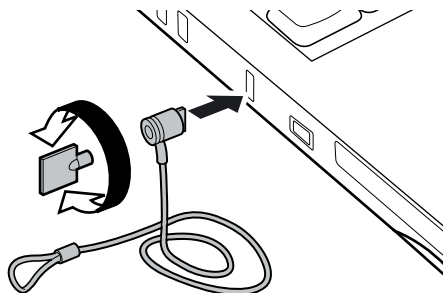

Security lock

Chapter 9

Troubleshooting

TOSHIBA designed the computer for durability. However, should problems occur, following the procedures in this chapter can help to determine the cause.

All readers should become familiar with this chapter. Knowing what might go wrong can help prevent problems from occurring.

Problem solving process

Resolving problems will be much easier if you observe the following guidelines:

- Stop immediately when you recognize a problem exists. Further action may result in data loss or damage. You may destroy valuable problem-related information that can help solve the problem.
- Observe what is happening. Write down what the system is doing and what actions you performed immediately before the problem occurred. If you have a printer attached, print a copy of the screen using **PrtSc**.

The questions and procedures offered in this chapter are meant as a guide, they are not definitive problem solving techniques. Many problems can be solved simply, but a few may require help from your dealer. If you find you need to consult your dealer or others, be prepared to describe the problem in as much detail as possible.

Preliminary checklist

Consider the simplest solution first. The items in this checklist are easy to fix and yet can cause what appears to be a serious problem.

- Make sure you turn on all peripheral devices before you turn on the computer. This includes your printer and any other external device you are using.
- Before you attach an external device, turn the computer off. When you turn the computer back on it recognizes the new device.
- Make sure all options are set properly in the setup program.
- Check all cables. Are they correctly and firmly attached? Loose cables can cause signal errors.
- Inspect all connecting cables for loose wires and all connectors for loose pins.
- Check that your diskette or CD/DVD-ROM is correctly inserted and that the diskette's write protect tab is correctly set.

Make notes of your observations and keep them in a permanent error log. This will help you describe your problems to your dealer. If a problem recurs, the log will help you identify the problem faster.

Analyzing the problem

Sometimes the system gives clues that can help you identify why it is malfunctioning. Keep the following questions in mind:

- Which part of the system is not operating properly: keyboard, floppy disk drives, hard disk drive, optical media drive, display. Each device produces different symptoms.
- Is the operating system configuration set properly? Check the configuration options.
- What appears on the display screen? Does it display any messages or random characters? Print a copy of the screen if you have a printer attached. Look up the messages in the software and operating system documentation. Check that all connecting cables are correctly and firmly attached. Loose cables can cause erroneous or intermittent signals.
- Do any indicators light? Which ones? What color are they? Do they stay on or blink? Write down what you see.
- Do you hear any beeps? How many? Are they long or short? Are they high pitched or low? Is the computer making any unusual noises? Write down what you hear.

Record your observations so you can describe them to your dealer.

Software	<p>The problems may be caused by your software or disk. If you cannot load a software package, the media may be damaged or the program might be corrupted. Try loading another copy of the software.</p> <p>If an error message appears while you are using a software package, check the software documentation. These documents usually include a problem solving section or a summary of error messages.</p> <p>Next, check any error messages in the OS documentation.</p>
Hardware	<p>If you cannot find a software problem, check your hardware. First run through the items in the preliminary checklist above. If you still cannot correct the problem, try to identify the source. The next section provides checklists for individual components and peripherals.</p>

Hardware and system checklist

This section discusses problems caused by your computer's hardware or attached peripherals. Basic problems may occur in the following areas:

- System start-up
- Self test
- Power
- Password
- Keyboard
- LCD panel
- Hard disk drive
- DVD-ROM drive
- CD-RW/DVD-ROM drive
- DVD Multi drive
- DVD±R/±RW drive (DVD Dual drive)
- Floppy disk drive
- SD card
- PC card
- Infrared port
- Dual Pointing device
- USB
- Memory expansion
- Sound system
- Monitor
- i.LINK (IEEE1394)
- Modem
- LAN
- Wireless LAN
- Bluetooth
- Real time clock (RTC)

System start-up

When the computer does not start properly, check the following items:

- Self Test
- Power Sources
- Power-on Password

Self test

When the computer starts up, the self test will be run automatically, and the following will be displayed:

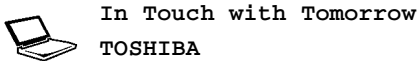

This message remains on the screen for a few seconds.

If the self test is successful, the computer tries to load the operating system, depending on how the Boot Priority is set in the TOSHIBA HW Setup program.

If any of the following conditions are present, the self test failed:

- The computer stops and does not proceed to display information or messages except the TOSHIBA logo.
- Random characters appear on the screen, and the system does not function normally.
- The screen displays an error message.

Turn off the computer and check all cable connections. If the test fails again, contact your dealer.

Power

When the computer is not plugged into an AC outlet, the battery pack is the primary power source. However, your computer has a number of other power resources, including intelligent power supply, Real Time Clock battery. These resources are interrelated and any one could affect apparent power problems. This section provides checklists for AC power and the battery. If you cannot resolve a problem after following them, the cause could lie with another power resource. In such case, contact your dealer.

Overheating power down

If the computer's internal temperature becomes too high, the computer will automatically enter Hibernation or Resume mode and shut down.

Problem	Procedure
Computer shuts down and DC IN 15V indicator blinks orange	Leave the computer off until the DC IN 15V indicator stops blinking.



It is recommended to leave the computer off until the its interior reaches room temperature even though the DC IN 15V indicator stops blinking. If the computer has reached room temperature and still does not start, or if it starts but shuts down quickly contact your dealer.

Computer shuts down and its **DC IN 15V** indicator is flashing in green

Indicates a problem with the heat dispersal system. Please contact your dealer.

AC power

If you have trouble turning on the computer with the AC adaptor connected, check the **DC IN 15V** indicator. Refer to Chapter 6, *Power and Power-Up Modes* for more information.

Problem	Procedure
AC adaptor doesn't power the computer (DC IN 15V indicator does not glow green)	<p>Check the connections. Make sure the cord is firmly connected to the computer and a power outlet.</p> <p>Check the condition of the cord and terminals. If the cord is frayed or damaged, replace it. If the terminals are soiled, wipe them with cotton or a clean cloth.</p> <p>If the AC adaptor still does not power the computer, contact your dealer.</p>

Battery

If you suspect a problem with the battery, check the **DC IN 15V** indicator as well as the **Battery** indicator. For information on indicators and battery operation see Chapter 6, *Power and Power-Up Modes*.

Problem	Procedure
Battery doesn't power the computer	The battery may be discharged. Connect the AC adaptor to charge the battery.

Problem	Procedure
Battery doesn't charge when the AC adaptor is attached (Battery or Slim Select bay indicator does not glow in orange.)	<p>If the battery is completely discharged, it will not begin charging immediately. Wait a few minutes.</p> <p>If the battery still does not charge, make sure the outlet of the AC adaptor is supplying power. Test it by plugging in an appliance.</p> <p>Check whether the battery is hot or cold to the touch. If the battery is too hot or too cold, it will not charge properly. Let it reach room temperature.</p> <p>Unplug the AC adaptor and remove the battery to make sure the terminals are clean. If necessary wipe them with a soft dry cloth dipped in alcohol.</p> <p>Connect the AC adaptor and replace the battery. Make sure it is securely seated.</p> <p>Check the Battery indicator. If it does not glow, let the computer charge the battery for at least 20 minutes. If the Battery indicator glows after 20 minutes, let the battery continue to charge at least another 20 minutes before turning on the computer.</p> <p>If the indicator still does not glow, the battery may be at the end of its operating life. Replace it.</p> <p>If you do not think the battery is at the end of its operating life, see your dealer.</p>
Battery doesn't power the computer as long as expected	<p>If you frequently recharge a partially charged battery, the battery might not charge to its full potential. Fully discharge the battery, then try to charge it again.</p> <p>Check the power consumption settings in Power Saver utility. Consider using a power saving mode.</p>

Password

Problem	Procedure
Cannot enter password	Refer to the <i>TOSHIBA Password Utility</i> section in Chapter 6, Power and Power-Up Modes.

Keyboard

Keyboard problems can be caused by your setup configuration. For more information refer to Chapter 5, *The Keyboard*.

Problem	Procedure
Some letter keys produce numbers	Check that the numeric keypad overlay is not selected. Press Fn + F11 and try typing again.
Output to screen is garbled	Make sure the software you are using is not remapping the keyboard. Remapping involves reassigning the meaning of each key. See your software's documentation. If you are still unable to use the keyboard, consult your dealer.

LCD panel

Apparent LCD problems may be related to the computer's setup. Refer to Chapter 7, *HW Setup*, for more information.

Problem	Procedure
No display	Press hotkeys Fn + F5 to change the display priority, to make sure it is not set for an external monitor.
Problems above remain unresolved or other problems occur	Refer to your software's documentation to determine if the software is causing the difficulty. Run the diagnostic test. Contact your dealer if the problems continue.

Hard disk drive

Problem	Procedure
Computer does not boot from hard disk drive	Check if a diskette is in the floppy disk drive. If a diskette is inserted, remove it and reboot. There may be a problem with your operating system files. Refer to your OS documentation.
Slow performance	Your files may be fragmented. Run SCANDISK and defragmenter to check the condition of your files and disk. Refer to your OS documentation or online HELP for information on running SCANDISK and the defragmenter. As a last resort, reformat the hard disk. Then, reload the operating system and other files. If problems persist, contact your dealer.

DVD-ROM drive

For more information, refer to Chapter 4, *Operating Basics*

Problem	Procedure
<p>You cannot access a CD/DVD in the drive</p>	<p>Make sure the drive's drawer is securely closed. Press gently until it clicks into place. Open the drawer and make sure the CD/DVD is properly seated. It should lie flat with the label facing up.</p> <p>A foreign object in the drawer could block laser light from reading the CD/DVD. Make sure there is no obstruction. Remove any foreign object.</p> <p>Check whether the CD/DVD is dirty. If it is, wipe it with a clean cloth dipped in water or a neutral cleaner. See the <i>Media care</i> section in Chapter 4, <i>Operating Basics</i>, for details on cleaning.</p>
<p>Some CD/DVDs run correctly, but others do not</p>	<p>The software or hardware configuration may be causing a problem. Make sure the hardware configuration matches your software's needs. Check the CD/DVD's documentation.</p> <p>Check the type of CD/DVD you are using. The drive supports:</p> <p>DVD-ROM: DVD-ROM, DVD-Video</p> <p>CD-ROM: CD-DA, CD-Text, Photo CD (single/multi-session), CD-ROM Mode 1, Mode 2, CD-ROM XA Mode 2 (Form1, Form2), Enhanced CD (CD-EXTRA), CD-G (Audio CD only), Addressing Method 2</p> <p>Check the region code on the DVD. It must match that on the DVD-ROM drive. Region codes are listed in the <i>Optical media drives</i> section in Chapter 2, <i>The Grand Tour</i>.</p> <p>If problems persist, contact your dealer.</p>

CD-RW/DVD-ROM drive

For more information, refer to Chapter 4, *Operating Basics*.

Problem	Procedure
You cannot access a CD/DVD in the drive	<p>Make sure the drive's drawer is securely closed. Press gently until it clicks into place.</p> <p>Open the drawer and make sure the CD/DVD is properly seated. It should lie flat with the label facing up.</p> <p>A foreign object in the drawer could block laser light from reading the CD/DVD. Make sure there is no obstruction. Remove any foreign object.</p> <p>Check whether the CD/DVD is dirty. If it is, wipe it with a clean cloth dipped in water or a neutral cleaner. See the <i>Media care</i> section in Chapter 4 for details on cleaning.</p>
Some CD/DVDs run correctly, but others do not	<p>The software or hardware configuration may be causing a problem. Make sure the hardware configuration matches your software's needs. Check the CD/DVD's documentation.</p> <p>Check the type of CD/DVD you are using. The drive supports:</p> <p>DVD-ROM: DVD-ROM, DVD-Video</p> <p>CD-ROM: CD-DA, CD-Text, Photo CD (single/multi-session), CD-ROM Mode 1, Mode 2, CD-ROM XA Mode 2 (Form1, Form2), Enhanced CD (CD-EXTRA), CD-G (Audio CD only), Addressing Method 2</p> <p>Recordable CD: CD-R, CD-RW</p> <p>Check the region code on the DVD. It must match that on the CD-RW/DVD-ROM drive. Region codes are listed in the <i>Optical media drives</i> section in Chapter 2, <i>The Grand Tour</i>.</p>

Problem	Procedure
Cannot write correctly	<p data-bbox="505 165 986 217">If you have trouble writing, make sure you are observing the following precautions:</p> <ul data-bbox="505 228 1020 533" style="list-style-type: none"><li data-bbox="505 228 1020 250">■ Use only media recommended by TOSHIBA.<li data-bbox="505 261 1020 312">■ Do not use the mouse or keyboard during writing.<li data-bbox="505 323 1020 375">■ Use only the software supplied with the computer for recording.<li data-bbox="505 386 1020 437">■ Do not run or start other software during writing.<li data-bbox="505 448 1020 470">■ Do not jar the computer during writing.<li data-bbox="505 481 1020 533">■ Do not connect/ disconnect external devices or install/remove internal cards during writing. <p data-bbox="505 544 925 566">If problems persist, contact your dealer.</p>

DVD Multi drive

For more information, refer to Chapter 4, *Operating Basics*.

Problem	Procedure
You cannot access a CD/DVD in the drive	<p>Make sure the drive's drawer is securely closed. Press gently until it clicks into place.</p> <p>Open the drawer and make sure the CD/DVD is properly seated. It should lie flat with the label facing up.</p> <p>A foreign object in the drawer could block laser light from reading the CD/DVD. Make sure there is no obstruction. Remove any foreign object.</p> <p>Check whether the CD/DVD is dirty. If it is, wipe it with a clean cloth dipped in water or a neutral cleaner. See the <i>Media care</i> section in Chapter 4 for details on cleaning.</p>
Some CD/DVDs run correctly, but others do not	<p>The software or hardware configuration may be causing a problem. Make sure the hardware configuration matches your software's needs. Check the CD/DVD's documentation.</p> <p>Check the type of CD/DVD you are using. The drive supports:</p> <p>DVD-ROM: DVD-ROM, DVD-Video</p> <p>Recordable DVD: DVD-R, DVD-RW, DVD-RAM</p> <p>CD-ROM: CD-DA, CD-Text, Photo CD (single/multi-session), CD-ROM Mode 1, Mode 2, CD-ROM XA Mode 2 (Form1, Form2), Enhanced CD (CD-EXTRA), CD-G (Audio CD only), Addressing Method 2</p> <p>Recordable CD: CD-R, CD-RW</p> <p>Check the region code on the DVD. It must match that on the CD-RW/DVD-ROM drive. Region codes are listed in the <i>Optical media drives</i> section in Chapter 2, <i>The Grand Tour</i>.</p>

Problem	Procedure
Cannot write correctly	<p>If you have trouble writing, make sure you are observing the following precautions:</p> <ul style="list-style-type: none"> ■ Use only media recommended by TOSHIBA. ■ Do not use the mouse or keyboard during writing. ■ Use only the software supplied with the computer for recording. ■ Do not run or start other software during writing. ■ Do not jar the computer during writing. ■ Do not connect/ disconnect external devices or install/remove internal cards during writing. <p>If problems persist, contact your dealer.</p>

DVD±R/±RW drive (DVD Dual drive)

For more information, refer to Chapter 4, *Operating Basics*.

Problem	Procedure
You cannot access a CD/DVD in the drive	<p>Make sure the drive's drawer is securely closed. Press gently until it clicks into place.</p> <hr/> <p>Open the drawer and make sure the CD/DVD is properly seated. It should lie flat with the label facing up.</p> <hr/> <p>A foreign object in the drawer could block laser light from reading the CD/DVD. Make sure there is no obstruction. Remove any foreign object.</p> <hr/> <p>Check whether the CD/DVD is dirty. If it is, wipe it with a clean cloth dipped in water or a neutral cleaner. See the <i>Media care</i> section in Chapter 4 for details on cleaning.</p> <hr/> <p>Some CD run correctly, but others do not</p> <p>The software or hardware configuration may be causing a problem. Make sure the hardware configuration matches your software's needs. Check the CD/DVD's documentation.</p>

Check the type of CD/DVD you are using. The drive supports:

DVD-ROM: DVD-ROM, DVD-Video, DVD-R, DVD-RW, DVD+R, DVD+RW

CD-ROM: CD-DA, CD-Text, Photo CD (single/multi-session), CD-ROM Mode 1, Mode 2, CD-ROM XA Mode 2 (Form1, Form2), Enhanced CD (CD-EXTRA), CD-G (Audio CD only), Addressing Method 2

Check the region code on the DVD. It must match that on the DVD±R/±RW drive. Region codes are listed in the *Optical media* section in Chapter 2, *The Grand Tour*.

Cannot write correctly	<p>If you have trouble writing, make sure you are observing the following precautions:</p> <ul style="list-style-type: none"> ■ Use only media recommended by TOSHIBA. ■ Do not use the mouse or keyboard during writing. ■ Use only the software supplied with the computer for recording. ■ Do not run or start other software during writing. ■ Do not jar the computer during writing. ■ Do not connect/ disconnect external devices or install/remove internal cards during writing. <p>If problems persist, contact your dealer.</p>
------------------------	--

Floppy disk drive

For more information, refer to Chapter 4, *Operating Basics*.

Problem	Procedure
Drive does not operate	There may be a faulty cable connection. Check the connection to the computer and to the drive.
Some programs run correctly but others do not	The software or hardware configuration may be causing a problem. Make sure the hardware configuration matches your software needs.
You cannot access the external 3 1/2" floppy disk drive	Try another diskette. If you can access the diskette, the original diskette (not the drive) is probably causing the problem. If problems persist, contact your dealer.

SD card

Refer also to Chapter 8, *Optional Devices*.

Problem	Procedure
SD card error occurs	Reseat the SD card to make sure it is firmly connected. Check the card's documentation.
You cannot write to an SD card	Make sure the card is not write protected.
You cannot read a file	Make sure the target file is on the SD Card inserted in the slot. If problems persist, contact your dealer.

PC card

Refer also to Chapter 8, *Optional Devices*.

Problem	Procedure
PC card error occurs	Reseat the PC card to make sure it is firmly connected. Make sure the connection between the external device and the card is firm. Check the card's documentation. If problems persist, contact your dealer.

Infrared port

Refer also to the documentation for your IrDA compatible device and related software.

Problem	Procedure
Infrared devices do not work as expected	Make sure there is no obstruction blocking communication between the computer and the target device. If problems persist, contact your dealer.

TOSHIBA Dual Pointing Device

If you are using a USB mouse, also refer to the *USB* section in this chapter and to your mouse documentation.

Touch pad/AccuPoint

Problem	Procedure
Either the Touch pad or the AccuPoint does not work.	<p>Check the Device Select settings. Open the Mouse properties icon and click the Dual Point tab. Then click the Detail Setting button and click the Device Select tab.</p> <p>Check that the Touch pad is not selected. Pressing Fn + F9 to enables TOSHIBA Dual Pointing Device.</p>
On-screen pointer does not respond to pad operation	<p>The system might be busy. If the pointer is shaped as an hourglass, wait for it to resume its normal shape and try again to move it.</p>
The mouse pointer moves too fast or too slow	<p>Try changing the speed setting in the mouse control utility.</p> <ol style="list-style-type: none"> 1. Open the Control Panel, select the Mouse icon and press Enter. 2. Click the Pointer Options tab. 3. Set the speed as instructed and click OK.
Double-tapping (Touch pad) or double-clicking (AccuPoint) does not work	<p>Try changing the double-click speed setting in the mouse control utility.</p> <ol style="list-style-type: none"> 1. Open the Control Panel, select the Mouse icon and press Enter. 2. Click the Buttons tab. 3. Set the double-click speed as instructed and click OK. <p>If problems persist, contact your dealer.</p>

USB mouse

Problem	Procedure
On-screen pointer does not respond to mouse operation	<p>The system might be busy. If the pointer is shaped as an hourglass, wait for it to resume its normal shape and try again to move it.</p> <p>Make sure the mouse is properly connected to the USB port.</p>

Problem	Procedure
Double-clicking does not work	Try changing the double-click speed setting in the mouse control utility. <ol style="list-style-type: none"> 1. Open the Control Panel, select the Mouse icon and press Enter. 2. Click the Buttons tab. 3. Set the double-click speed as instructed and click OK.
The mouse pointer moves too fast or too slow	Try changing the speed setting in the mouse control utility. <ol style="list-style-type: none"> 1. Open the Control Panel, select the Mouse icon and press Enter. 2. Click the Pointer Options tab. 3. Set the speed as instructed and click OK.
The mouse pointer moves erratically	The mouse might be dirty. Refer to your mouse documentations for instructions on cleaning. If problems persist, contact your dealer.

USB

Refer also to your USB device's documentation.

Problem	Procedure
USB device does not work	Check for a firm cable connection between the USB ports on the computer and the USB device. Make sure the USB device drivers are properly installed. Refer to your Windows XP documentation for information on checking the drivers. If problems persist, contact your dealer.

Memory expansion

Refer also to Chapter 8, *Optional Devices*, for information on installing memory modules.

Problem	Procedure
Beep sounds. (Two beeps, a dash and a dot, for a defective memory module in slot A. Three beeps, a dash and two dots for slot B. When both beeps sound, both memories in slot A and B are defective.)	<p>Make sure the memory module installed in the expansion slot is compatible with the computer. If an incompatible module has been installed, follow the steps below.</p> <ol style="list-style-type: none"> 1. Disconnect the AC adaptor and all peripheral devices. 2. Remove the battery. 3. Remove the memory module. 4. Replace the battery and/or connect the AC adaptor. 5. Turn on the power. <p>If problems persist, contact your dealer.</p>

Sound system

Refer also to documentation for your audio devices.

Problem	Procedure
No sound is heard	<p>Adjust the volume control dial. Check the software volume settings. Make sure the headphone connection is secure. If problems persist, contact your dealer.</p>
Annoying sound is heard	<p>You may be experiencing feedback. Refer to <i>Sound system</i> in Chapter 4, <i>Operating Basics</i>. If problems persist, contact your dealer.</p>

Monitor

Refer also to Chapter 8, *Optional Devices*, and to your monitor's documentation.

Problem	Procedure
Monitor does not turn on	Make sure that the external monitor's power switch is on. Confirm that the external monitor's power cable is plugged into a working power outlet.
No display	Try adjusting the contrast and brightness controls on the external monitor. Press hot keys Fn + F5 to change the display priority and make sure it is not set for the internal display.
Display error occurs	Check that the cable connecting the external monitor to the computer is attached firmly. If problems persist, contact your dealer.

i.LINK (IEEE1394)

Problem	Procedure
i.LINK device does not function	Make sure the cable is securely connected to the computer and to the device. Make sure the device's power is turned on. Reinstall the drivers. Open the Windows Control Panel and double-click the Add Hardware icon. Follow the on-screen directions. Restart Windows. If problems persist, contact your dealer.

Modem

Problem	Procedure
Communication software can't initialize modem	Make sure the computer's internal modem settings are correct. Refer to <i>Phone and Modem Properties</i> in the Control Panel.
You can hear a dial tone but can't make a call	If the call is going through a PBX machine, make sure the communication application's tone dial detection feature is disabled. You can also use the ATX command.

Problem	Procedure
You place a call, but a connection can't be made	Make sure the settings are correct in your communications application.
After making a call you can't hear a ring	Make sure the tone or pulse selection in your communications application is set correctly. You can also use the ATD command.
Communication is cut off unexpectedly	The computer will automatically cut off communication when connection with the carrier is not successful for a set time interval. Try lengthening this time interval.
A CONNECT display is quickly replaced by NO CARRIER	Check the error control setting in your communications application. You can also use the ATN command.
Character display becomes garbled during a communication	In data transmission, make sure the parity bit and stop bit settings correspond with those of the remote computer. Check the flow control and communication protocol.
You cannot receive an incoming call	Check the rings before auto answer setting in your communications application. You can also use the ATSO command. If problems persist, contact your dealer.

LAN

Problem	Procedure
Cannot access LAN Wake-up on LAN does not work	Check for a firm cable connection between the LAN jack and the LAN HUB. Make sure the AC adaptor is connected. The Wake-up on LAN function consumes power even when the system is off. If problems persist, consult your LAN administrator.

Wireless LAN

If the following procedures do not restore LAN access, consult your LAN administrator. For more information on wireless communication, refer to Chapter 4, *Operating Basics*.

Problem	Procedure
Cannot access Wireless LAN	Make sure the computer's wireless communication switch is set to on. If problems persist, contact your LAN administrator.

Bluetooth

For more information on wireless communication, refer to Chapter 4, *Operating Basics*.

Problem	Procedure
Cannot access Bluetooth device	Make sure the computer's wireless communication switch is set to on. Make sure the Bluetooth Manager is running and the power to the Bluetooth device is turned on. Make sure no optional Bluetooth SD card 2 is installed in the computer. The built-in Bluetooth function and an optional Bluetooth SD card 2 cannot operate simultaneously. If problems persist, contact your dealer.

Real Time Clock

Problem	Procedure
The following message is Displayed on the LCD: RTC battery is low or CMOS checksum is inconsistent. Press [F1] key to set Date/Time.	The battery for RTC is wearing. Set the date and time in BIOS setup with the following steps: 1. Press [F1] key. BIOS setup will boot up. 2. Set the date in [System Date]. 3. Set the time in [System Time]. 4. Press the [End] key. Confirmation message will appear. 5. Press [Y] key. BIOS setup will terminate and the computer will be rebooted.

TOSHIBA support

If you require any additional help using your computer or if you are having problems operating the computer, you may need to contact TOSHIBA for additional technical assistance.

Before you call

Some problems you experience may be related to software or the operating system, it is important to investigate other sources of assistance first. Before contacting TOSHIBA, try the following:

- Review troubleshooting sections in the documentation for software and peripheral devices.
- If a problem occurs when you are running software applications, consult the software documentation for troubleshooting suggestions. Call the software company's technical support for assistance.
- Consult the dealer you purchased your computer and/or software from. They are your best sources for current information and support.

Where to write

If you are still unable to solve the problem and suspect that it is hardware related, write to TOSHIBA at the location listed in the accompanying warranty booklet or visit www.toshiba-europe.com on the Internet.

Appendix A

Specifications

This appendix summarizes the computer's technical specifications.

Physical Dimensions

Weight (typical)	2.26 kilograms, configured with: 14" XGA, 256MB RAM, 40GB HDD, DVD-ROM drive, modem, LAN(100 Mbit), Wireless LAN, 6cell battery. Weight will vary with other configurations. Above weights are measured at a specific criteria. They are not guaranteed as the maximum weight of the actual product.
Size	314 (w) x 260 (d) x 31.5/34.9(h) millimeters (not including parts that extend beyond the main body)

Environmental Requirements

Conditions	Ambient temperature	Relative humidity
Operating	5°C (41°F) to 35°C (95°F)	20% to 80%
Non-operating	-20°C (-4°F) to 65°C (149°F)	10% to 95%
Thermal Gradient	20°C per hour maximum	
Wet-bulb temperature	26°C maximum	
Conditions	Altitude (from sea level)	
Operating	-60 to 3,000 meters	
Non-operating	-60 to 10,000 meters maximum	

Power Requirements

AC adaptor	100-240 volts AC
	50 or 60 hertz (cycles per second)
Computer	15 VDC
	5.0 amperes

Built-in Modem

Network control unit (NCU)

Type of NCU	AA
Type of line	Telephone line (analog only)
Type of dialing	Pulse Tone
Control command	AT commands EIA-578 commands
Monitor function	Computer's speaker

Communication specifications

Communication system	Data: Full duplex Fax: Half duplex
Communication protocol	Data ITU-T-Rec V.21/V.22/V.22bis/V.32 (Former CCITT) /V.32bis/V.34/V.90 Bell 103/212A Fax ITU-T-Rec V.17/V.29/V.27ter (Former CCITT) /V.21 ch2
Communication speed	Data transmission and reception 300/1200/2400/4800/7200/9600/12000/14400/ 16800/19200/21600/24000/26400/28800/ 31200/3600 bp Data reception only with V.90 28000/29333/30666/32000/33333/34666/ 36000/37333/38666/40000/41333/42666/ 44000/45333/46666/48000/49333/50666/ 52000/53333/54666/56000 bps Fax 2400/4800/7200/9600/12000/14400 bps

Network control unit (NCU)

Transmitting level -10 dBm**Receiving level** -10 to -40 dBm**Input/output impedance** 600 ohms \pm 30%**Error correcting** MNP class 4 and ITU-T V.42**Data compression** MNP class 5 and ITU-T V.42bis**Power supply** +3.3V (supplied by computer)

Appendix B

AC Power Cord and Connectors

The power cord's AC input plug must be compatible with the various international AC power outlets and the cord must meet the standards for the country/region in which it is used. All cords must meet the following specifications:

Length:	Minimum 2 meters
Wire size:	Minimum 0.75 mm ²
Current rating:	Minimum 2.5 amperes
Voltage rating:	125 or 250 VAC (depending on country/region's power standards)

Certification agencies

U.S. and Canada:	UL listed and CSA certified No. 18 AWG, Type SVT or SPT-2 two conductor		
-------------------------	--	--	--

Australia:	AS		
-------------------	----	--	--

Japan:	DENANHO		
---------------	---------	--	--

Europe:

Austria:	OVE	Italy:	IMQ
-----------------	-----	---------------	-----

Belgium:	CEBEC	The Netherlands:	KEMA
-----------------	-------	-------------------------	------

Denmark:	DEMKO	Norway:	NEMKO
-----------------	-------	----------------	-------

Finland:	SETI	Sweden:	SEMKO
-----------------	------	----------------	-------

France:	UTE	Switzerland:	SEV
Germany:	VDE	United Kingdom:	BSI

In Europe, power cords must be VDE type, H05VVH2-F and two conductor. For the United States and Canada, plug configuration must be a 2-15P (250 V) or 1-15P (125 V) as designated in the U.S. National Electrical code handbook and the Canadian Electrical Code Part II.

The following illustrations show the plug shapes for the U.S.A. and Canada, the United Kingdom, Australia and Europe.

USA and Canada

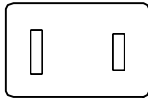

UL approved
CSA approved

United Kingdom

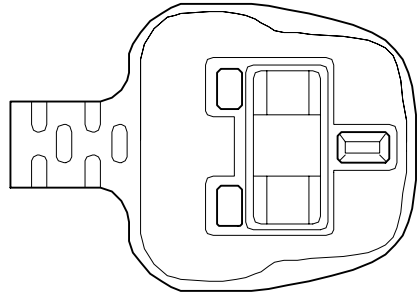

BS approved

Australia

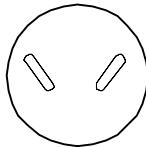

AS approved

Europe

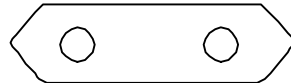

Approved by the
appropriate agency

Appendix C

Display Controller and Modes

Display controller

The display controller interprets software commands into hardware commands that turn particular pels on or off.

The controller is an advanced Video Graphics Array (VGA) that provides Super VGA (SVGA) and Extended Graphics Array (XGA), Super Extended Graphics Array (SXGA), Super Extended Graphics Array plus (SXGA+), support for the internal LCD and external monitors.

Two models are available:

- 14.1" XGA, 1024 horizontal × 768 vertical pixels
- 14.1" SXGA+, 1400 horizontal × 1050 vertical pixels



Because of the LCD's increased resolution, lines may appear broken in DOS mode.

A high-resolution external monitor connected to the computer can display up to 2048 horizontal and 1536 vertical pixels at up to 16M colors.

The display controller also controls the video mode, which uses industry standard rules to govern the screen resolution and the maximum number of colors that can be displayed on screen.

Software written for a given video mode will run on any computer that supports the mode.

The computer's display controller supports all VGA and SVGA modes, the most widely used industry standards.

Video modes

The computer supports video modes defined in the tables below. If your application offers a selection of mode numbers that do not match the numbers on the table, select a mode based on mode type, resolution, character matrix, number of colors and refresh rates. Also, if your software supports both graphics and text modes, the screen display may appear to operate faster using a text mode.

Table1 Video modes (VGA)

Video mode	Type	Resolution	Character matrix (pels)	LCD colors	CRT colors	Scanning frequency Vertical (Hz)
0, 1	VGA Text	40 × 25 Characters	8 × 8	16 of 256K	16 of 256K	70
2, 3	VGA Text	80 × 25 Characters	8 × 8	16 of 256K	16 of 256K	70
0*, 1*	VGA Text	40 × 25 Characters	8 × 14	16 of 256K	16 of 256K	70
2*, 3*	VGA Text	80 × 25 Characters	8 × 14	16 of 256K	16 of 256K	70
0+, 1+	VGA Text	40 × 25 Characters	9 × 16	16 of 256K	16 of 256K	70
2+, 3+	VGA Text	80 × 25 Characters	9 × 16	16 of 256K	16 of 256K	70
4, 5	VGA Grph	320 × 200 Pels	8 × 8	4 of 256K	4 of 256K	70
6	VGA Grph	640 × 200 Pels	8 × 8	2 of 256K	2 of 256K	70
7	VGA Text	80 × 25 Characters	9 × 14	Mono	Mono	70
7+	VGA Text	80 × 25 Characters	9 × 16	Mono	Mono	70

Table1 Video modes (VGA) continued

Video mode	Type	Resolution	Character matrix (pels)	LCD colors	CRT colors	Scanning frequency Vertical (Hz)
D	VGA Grph	320 × 200 Pels	8 × 8	16 of 256K	16 of 256K	70
E	VGA Grph	640 × 200 Pels	8 × 8	16 of 256K	16 of 256K	70
F	VGA Grph	640 × 350 Pels	8 × 14	Mono	Mono	70
10	VGA Grph	640 × 350 Pels	8 × 14	16 of 256K	16 of 256K	70
11	VGA Grph	640 × 480 Pels	8 × 16	2 of 256K	2 of 256K	60
12	VGA Grph	640 × 480 Pels	8 × 16	16 of 256K	16 of 256K	60
13	VGA Grph	320 × 200 Pels	8 × 8	256 of 256K	256 of 256K	70

Table 2 Video modes (XGA)

Resolution	LCD colors	CRT colors	Vertical frequency (Hz)
640 × 480	256/256K	256/256K	60 75 85 100
800 × 600	256/256K	256/256K	60 75 85 100
1024 × 768	256/256K	256/256K	60 75 85 100
1280 × 1024	256/256K (Virtual)	256/256K	60 75 85 100
1600 × 1200	256/256K (Virtual)	256/256K	60 75 85 100
1920 × 1440	256/256K (Virtual)	256/256K	60 75 85
2048 × 1536	256/256K (Virtual)	256/256K	60 75



Some SVGA modes are not supported at LCD+CRT simultaneous mode and LCD+CRT Multi Monitor mode.

Table 2 Video modes (XGA) continued

Resolution	LCD colors	CRT colors	Vertical frequency (Hz)
640 × 480	64K/64K	64K/64K	60 75 85 100
800 × 600	64K/64K	64K/64K	60 75 85 100
1024 × 768	64K/64K	64K/64K	60 75 85 100
1280 × 1024	64K/64K (Virtual)	64K/64K	60 75 85 100
1600 × 1200	64K/64K (Virtual)	64K/64K	60 75 85 100
1920 × 1440	64K/64K (Virtual)	64K/64K	60 75 85
2048 × 1536	64K/64K (Virtual)	64K/64K	60 75



Some SVGA modes are not supported at LCD+CRT simultaneous mode and LCD+CRT Multi Monitor mode.

Table 2 Video modes (XGA) continued

Resolution	LCD colors	CRT colors	Vertical frequency (Hz)
640 × 480	16M/16M	16M/16M	60 75 85 100
800 × 600	16M/16M	16M/16M	60 75 85 100
1024 × 768	16M/16M	16M/16M	60 75 85 100
1280 × 1024	16M/16M (Virtual)	16M/16M	60 75 85 100
1600 × 1200	16M/16M (Virtual)	16M/16M	60 75 85 100
1920 × 1440	16M/16M (Virtual)	16M/16M	60 75
2048 × 1536	16M/16M (Virtual)	16M/16M	60 75



Some SVGA modes are not supported at LCD+CRT simultaneous mode and LCD+CRT Multi Monitor mode.

Table 3 Video modes (Super XGA+)

Resolution	LCD colors	CRT colors	Vertical frequency (Hz)
640 × 480	256/256K	256/256K	60 75 85 100
800 × 600	256/256K	256/256K	60 75 85 100
1024 × 768	256/256K	256/256K	60 75 85 100
1280 × 1024	256/256K	256/256K	60 75 85 100
1400 × 1050	256/256K	256/256K	60
1600 × 1200	256/256K (Virtual)	256/256K	60 75 85 100
1920 × 1440	256/256K (Virtual)	256/256K	60 75 85
2048 × 1536	256/256K (Virtual)	256/256K	60 75

Table 3 Video modes (Super XGA+) continued

Resolution	LCD colors	CRT colors	Vertical frequency (Hz)
640 × 480	64K/64K	64K/64K	60 75 85 100
800 × 600	64K/64K	64K/64K	60 75 85 100
1024 × 768	64K/64K	64K/64K	60 75 85 100
1280 × 1024	64K/64K	64K/64K	60 75 85 100
1400 × 1050	64K/64K	64K/64K	60
1600 × 1200	64K/64K (Virtual)	64K/64K	60 75 85 100
1920 × 1440	64K/64K (Virtual)	64K/64K	60 75 85
2048 × 1536	64K/64K (Virtual)	64K/64K	60 75

Table 3 Video modes (Super XGA+) continued

Resolution	LCD colors	CRT colors	Vertical frequency (Hz)
640 × 480	16M/16M	16M/16M	60 75 85 100
800 × 600	16M/16M	16M/16M	60 75 85 100
1024 × 768	16M/16M	16M/16M	60 75 85 100
1280 × 1024	16M/16M	16M/16M	60 75 85 100
1400 × 1050	16M/16M	16M/16M	60
1600 × 1200	16M/16M (Virtual)	16M/16M	60 75 85 100
1920 × 1440	16M/16M (Virtual)	16M/16M	60 75
2048 × 1536	16M/16M (Virtual)	16M/16M	60 75



Some SVGA modes are not supported at LCD+CRT simultaneous mode and LCD+CRT Multi Monitor mode.

Appendix D

If your computer is stolen



Always take care of your computer and try to prevent it from being stolen. You are the owner of a valuable technical device, which may be highly attractive to thieves, so please do not leave it unattended in a public place. To further help protect against theft, security cables can be bought for use with your notebook when it is being used at home or in the office.

Make a note of your computer's machine type, model number, and serial number, and put it in a safe place. You will find this information on the underside of your notebook. Please also keep the receipt of the computer you purchased.

Should your computer be stolen, however, we'll help you try to find it. Before contacting TOSHIBA, please prepare the following information which is necessary to uniquely identify your computer:

- In which country was your computer stolen?
- What type of machine do you have?
- What was the model number (PA number)?
- What was the serial number (8 digits)?
- When was it stolen, i.e. date?
- What was the warranty seal number (if available)?
- What is your address, phone, and fax number?

To register the theft, please follow these procedures:

- Fill in the TOSHIBA Theft Registration form (or a copy of it) below.
- Attach a copy of your receipt showing where your computer was purchased.
- Either fax or send the receipt and registration form to the address below.

Your registration will be entered in a database, which is used to track TOSHIBA computers at our service points around Europe.

TOSHIBA Theft Registration

Send to: TOSHIBA Europe GmbH
 Technical Service and Support
 Leibnizstr. 2
 93055 Regensburg
 Germany

Fax number: +49 (0) 941 7807 925

Country stolen:	
Machine type: (e.g. Tecra M2)	
Model number: (e.g. PTM20 YXT)	
Serial number: (e.g. 70123456E)	
Date stolen:	
Warranty seal: (e.g. 9813 123456 049)	

Owner's details

Name:	
Company:	
Street:	
Postal Code/City:	
Country:	
Phone:	
Fax:	

Appendix E

ASCII Character Codes

This appendix shows the American Standard Code for Information Interchange (ASCII) on the following pages. The characters in the **IBM char** column appear on your display when you type the corresponding ASCII code (as described in Chapter 5, Keyboard). The characters that are printed, however, depend on the software you are using. For most software, the printed output for decimal codes 32 to 128 will match your screen display.

Dec code	Hex code	IBM char	Sort seq	Ctrl char
000	00		000	NUL
001	01	☺	1	SOH
002	02	☻	2	STX
003	03	♥	3	ETX
004	04	♦	4	EOT
005	05	♣	5	ENQ
006	06	♠	6	ACK
007	07	•	7	BEL
008	08	◼	8	BS
009	09	○	9	HT
010	0A	◻	10	LF
011	0B	○	11	VT
012	0C	○	12	FF
013	0D	♪	13	CR
014	0E	🎵	14	SO
015	0F	⚙	15	SI
016	10	▶	16	DLE
017	11	◀	17	DC1
018	12	↕	18	DC2
019	13	!!	19	DC3
020	14	¶	20	DC4
021	15	§	21	NAK
022	16	▬	22	SYN
023	17	↕	23	ETB
024	18	↑	24	CAN
025	19	↓	25	EM
026	1A	→	26	SUB
027	1B	←	27	ESC
028	1C	└	28	FS
029	1D	↔	29	GS
030	1E	▲	30	RS
031	1F	▼	31	US

Dec code	Hex code	IBM char	Sort seq
032	20	space	32
033	21	!	33
034	22	"	34
035	23	#	35
036	24	\$	36
037	25	%	37
038	26	&	38
039	27	'	39
040	28	(40
041	29)	41
042	2A	*	42
043	2B	+	43
044	2C	,	44
045	2D	-	45
046	2E	.	46
047	2F	/	47
048	30	0	48
049	31	1	49
050	32	2	50
051	33	3	51
052	34	4	52
053	35	5	53
054	36	6	54
055	37	7	55
056	38	8	56
057	39	9	57
058	3A	:	58
059	3B	;	59
060	3C	<	60
061	3D	=	61
062	3E	>	62
063	3F	?	63

Dec code	Hex code	IBM char	Sort seq
064	40	@	64
065	41	A	65
066	42	B	66
067	43	C	67
068	44	D	68
069	45	E	69
070	46	F	70
071	47	G	71
072	48	H	72
073	49	I	73
074	4A	J	74
075	4B	K	75
076	4C	L	76
077	4D	M	77
078	4E	N	78
079	4F	O	79
080	50	P	80
081	51	Q	81
082	52	R	82
083	53	S	83
084	54	T	84
085	55	U	85
086	56	V	86
087	57	W	87
088	58	X	88
089	59	Y	89
090	5A	Z	90
091	5B	[91
092	5C	\	92
093	5D]	93
094	5E	^	94
095	5F	_	95

Dec code	Hex code	IBM char	Sort seq	Dec code	Hex code	IBM char	Sort seq
096	60	'	96	128	80	Ç	67
097	61	a	97	129	81	ü	85
098	62	b	98	130	82	é	69
099	63	c	99	131	83	â	65
100	64	d	100	132	84	ä	65
101	65	e	101	133	85	à	65
102	66	f	102	134	86	å	65
103	67	g	103	135	87	ç	67
104	68	h	104	136	88	è	69
105	69	i	105	137	89	ë	69
106	6A	j	106	138	8A	è	69
107	6B	k	107	139	8B	ï	73
108	6C	l	108	140	8C	î	73
109	6D	m	109	141	8D	ì	73
110	6E	n	110	142	8E	À	65
111	6F	o	111	143	8F	Å	65
112	70	p	112	144	90	É	69
113	71	q	113	145	91	æ	65
114	72	r	114	146	92	Æ	65
115	73	s	115	147	93	ô	79
116	74	t	116	148	94	ö	79
117	75	u	117	149	95	ò	79
118	76	v	118	150	96	ù	85
119	77	w	119	151	97	ù	85
120	78	x	120	152	98	ÿ	89
121	79	y	121	153	99	Ö	79
122	7A	z	122	154	9A	Ü	85
123	7B	{	123	155	9B	ç	36
124	7C		124	156	9C	£	36
125	7D	}	125	157	9D	¥	36
126	7E	~	126	158	9E	Pt	36
127	7F	△	127	159	9F	f	36

Dec code	Hex code	IBM char	Sort seq	Dec code	Hex code	IBM char	Sort seq
160	A0	á	65	192	C0	└	
161	A1	í	73	193	C1	┘	
162	A2	ó	79	194	C2	┐	
163	A3	ú	85	195	C3	┌	
164	A4	ñ	78	196	C4	├	
165	A5	Ñ	78	197	C5	┤	
166	A6	ā	166	198	C6	┆	
167	A7	ō	167	199	C7	┇	
168	A8	¿	63	200	C8	┏	
169	A9	┌	169	201	C9	┐	
170	AA	└	170	202	CA	┘	
171	AB	½	171	203	CB	┐	
172	AC	¼	172	204	CC	┆	
173	AD	ı	33	205	CD	═	
174	AE	«	34	206	CE	≠	
175	AF	»	34	207	CF	≠	
176	B0	▄		208	D0	┘	
177	B1	▄		209	D1	┐	
178	B2	▄		210	D2	┐	
179	B3	┌		211	D3	┏	
180	B4	└		212	D4	┐	
181	B5	┆		213	D5	┐	
182	B6	┆		214	D6	┐	
183	B7	┐		215	D7	≠	
184	B8	┐		216	D8	≠	
185	B9	┐		217	D9	┘	
186	BA	┐		218	DA	┐	
187	BB	┐		219	DB	■	
188	BC	┐		220	DC	■	
189	BD	┐		221	DD	■	
190	BE	┐		222	DE	■	
191	BF	┐		223	DF	■	

Dec code	Hex code	IBM char	Sort seq
224	E0	α	
225	E1	β	83
226	E2	Γ	
227	E3	Π	
228	E4	Σ	
229	E5	σ	
230	E6	μ	
231	E7	Υ	
232	E8	Φ	
233	E9	Θ	
234	EA	Ω	
235	EB	δ	
236	EC	φ	
237	ED	φ	
238	EE	Ε	
239	EF	Λ	
240	F0	Ξ	
241	F1	±	
242	F2	≥	
243	F3	≤	
244	F4	∫	
245	F5	∫	
246	F6	+	
247	F7	≈	
248	F8	◦	
249	F9	■	
250	FA	■	
251	FB	√	
252	FC	η	
253	FD	²	
254	FE	■	
255	FF		

Appendix F

Wireless LAN

Card Specifications

Form Factor	Mini PCI TypeIII
Compatibility	<ul style="list-style-type: none"> ■ IEEE 802.11 Standard for Wireless LANS ■ Wi-Fi (Wireless Fidelity) certified by the Wi-Fi Alliance. The 'Wi-Fi CERTIFIED' logo is a certification mark of the Wi-Fi Alliance.
Network Operating System	<ul style="list-style-type: none"> ■ Microsoft Windows® Networking
Media Access Protocol Data Rate	<ul style="list-style-type: none"> ■ CSMA/CA (Collision Avoidance) with Acknowledgement (ACK) ■ 54/48/36/24/18/12/9/6 Mb/s (Revision A and G, Revision A/B, B/G, A/B/G combo type) ■ 11/5.5/2/1 Mb/s (Revision B) ■ 108/96/72/48/36/24/18/12 Mb/s (Turbo Mode, Revision A/B/G combo type)

Radio Characteristics

Radio Characteristics of Wireless LAN Cards may vary according to:

- Country/region where the product was purchased
- Type of product

Wireless communication is often subject to local radio regulations. Although Wireless LAN wireless networking products have been designed for operation in the license-free 2.4GHz and 5GHz band, local radio regulations may impose a number of limitations to the use of wireless communication equipment.



Refer to the sheet "Information to the User" for regulatory information that may apply in your country/region.

R-F Frequency	<ul style="list-style-type: none"> ■ Band 5GHz (5150-5850 MHz) (Revision A, Turbo Mode) ■ Band 2.4GHz (2400-2483.5 MHz) (Revision B, G)
Modulation Technique	<ul style="list-style-type: none"> ■ DSSS-CCK, DSSS-DQPSK, DSSS-DBPSK (Revision B) ■ OFDM-BPSK, OFDM-QPSK, OFDM-16QAM, OFDM-64QAM (Revision A, G, Turbo Mode)

The range of the wireless signal is related to the Transmit Rate of the wireless communication. Communications at lower Transmit range may travel larger distances.

- The range of your wireless devices can be affected when the antennas are placed near metal surfaces and solid high-density materials.
- Range is also impacted due to "obstacles" in the signal path of the radio that may either absorb or reflect the radio signal.

Supported Frequency Sub-bands

Subject to the radio regulations that apply in the countries/regions, your Wireless LAN card may support a different set of 5GHz / 2.4GHz channels. Consult your Authorized Wireless LAN or TOSHIBA Sales office for information about the radio regulations that apply in the countries/regions.

Wireless IEEE 802.11 Channels Sets (Revision B and G)

Frequency Range	2400-2483.5 MHz
Channel ID	
1	2412
2	2417
3	2422
4	2427
5	2432
6	2437
7	2442
8	2447
9	2452
10	2457 *1
11	2462
12	2467 *2
13	2472 *2

*1 Factory-set default channels

*2 Refer to the sheet *Approved Countries/Regions for use* for the countries/regions that in which these channels can be used. When installing Wireless LAN cards, the channel configuration is managed as follows:

- For wireless clients that operate in a Wireless LAN Infrastructure, the Wireless LAN card will automatically start operation at the channel identified by the Wireless LAN Access Point, When roaming between different access points the station can dynamically switch to another channel if required.
- For Wireless LAN cards installed in Wireless clients that operating in a peer-to-peer mode, the card will use the default channel 10.
- In a Wireless LAN Access Point, the Wireless LAN card will use the factory-set default channel (printed in bold), unless the LAN Administrator selected a different channel when configuring the Wireless LAN Access Point device.

Wireless IEEE 802.11 Channels Sets (Revision A)

Frequency Range Channel ID	5150-5850 MHz	Note
36	5180	
40	5200	
44	5220	
48	5240	
52	5260	
56	5280	
60	5300	
64	5320	
149	5745	
153	5765	
157	5785	
161	5805	

Wireless Channels Sets (Turbo Mode)

Frequency Range Channel ID	5150-5850 MHz	Note
42	5210	US only *
50	5250	US only *
58	5290	US only *
152	5760	US only *
160	5800	US only *

* Available Area: US (USA, CANADA) only

Appendix G

Internal Modem Guide

This appendix describes how to install and the remove the internal modem.



Do not disassemble the computer beyond the steps described in this instruction or touch any components not specifically described.

Installing the internal modem



The internal modem is preinstalled. The following is for information only.

To install the internal modem, follow the steps below.

1. Save your data and turn off the computer.
2. Disconnect the AC adaptor and other peripheral devices.
3. Turn the computer upside down and remove the battery pack.
4. Remove one screw securing the cover.
5. Slip your fingernail or a narrow object into a notch under the cover and lift off the cover.
6. Remove two screws, which you use later to secure the modem board.
7. Connect the modem board cable and seat the modem board.
8. Secure the modem board with two screws removed in step 6.
9. Secure the cover with one screw.

Removing the internal modem

To remove the internal modem, follow the steps below.

1. Save your data and turn off the computer.
2. Disconnect the AC adaptor and any other peripheral device.
3. Turn the computer upside down and remove the battery pack.
4. Remove one screw securing the cover.
5. Remove the modem cover.
6. Remove two screws and remove the modem board.
7. Disconnect the modem cable.
8. Secure the modem cover with one screw.
9. Install the battery pack.

Refer to the installation procedures for details.

Glossary

The terms in this glossary cover topics related to this manual. Alternate naming is included for reference.

A

AccuPoint: A pointing device integrated into the TOSHIBA computer keyboard.

adaptor: A device that provides an interface between two dissimilar electronic devices. For example, the AC adaptor modifies the power from a wall outlet for use by the computer. This term also refers to the add-in circuit cards that control external devices, such as video monitors and magnetic tape devices.

allocate: To assign a space or function for a specific task.

alphanumeric: Keyboard characters including letters, numbers and other symbols, such as punctuation marks or mathematical symbols.

alternating current (AC): Electric current that reverses its direction of flow at regular intervals.

analog signal: A signal whose characteristics such as amplitude and frequency vary in proportion to (are an analog of) the value to be transmitted. Voice communications are analog signals.

ANSI: American National Standards Institute. An organization established to adopt and define standards for a variety of technical disciplines. For example, ANSI defined the ASCII standard and other information processing requirements.

antistatic: A material used to prevent the buildup of static electricity.

application: A group of programs that together are used for a specific task such as accounting, financial planning, spreadsheets, word processing and games.

ASCII: American Standard Code for Information Interchange. ASCII code is a set of 256 binary codes that represent the most commonly used letters, numbers, and symbols.

async: Short for asynchronous.

asynchronous: Lacking regular time relationship. As applied to computer communications, asynchronous refers to the method of transmitting data that does not require a steady stream of bits to be transmitted at regular time intervals.

B

backup: A duplicate copy of files kept as a spare in case the original is destroyed.

batch file: A file that can be executed from the system prompt containing a sequence of operating system commands or executable files.

binary: The base two number system composed of zeros and ones (off or on), used by most digital computers. The right-most digit of a binary number has a value of 1, the next a value of 2, then 4, 8, 16, and so on. For example, the binary number 101 has a value of 5. *See also* ASCII.

BIOS: Basic Input Output System. The firmware that controls data flow within the computer. *See also* firmware.

bit: Derived from "binary digit," the basic unit of information used by the computer. It is either zero or one. Eight bits is one byte. *See also* byte.

board: A circuit board. An internal card containing electronic components, called chips, which perform a specific function or increase the capabilities of the system.

boot: Short for bootstrap. A program that starts or restarts the computer. The program reads instructions from a storage device into the computer's memory.

bps: Bits per second. Typically used to describe the data transmission speed of a modem.

buffer: The portion of the computer's memory where data is temporarily stored. Buffers often compensate for differences in the rate of flow from one device to another.

bus: An interface for transmission of signals, data or electric power.

byte: The representation of a single character. A sequence of eight bits treated as a single unit; also the smallest addressable unit within the system.

C

cache memory: High speed memory which stores data that increases processor speed and data transfer rate. When the CPU reads data from main memory, it stores a copy of this data in cache memory. The next time the CPU needs that same data, it looks for it in the cache memory rather than the main memory, which saves time. The computer has two cache levels. Level one is incorporated into the processor and level two resides in external memory.

capacity: The amount of data that can be stored on a magnetic storage device such as a diskette (floppy disk) or hard disk. It is usually described in terms of kilobytes (KB), where one KB = 1024 bytes and megabytes (MB), where one MB = 1024 KB.

card: Synonym for board. See board.

CardBus: An industry standard bus for 32-bit PC cards.

CD-ROM: A Compact Disc-Read Only Memory is a high capacity disc that can be read from but not written to. The CD-ROM drive uses a laser, rather than magnetic heads, to read data from the disc.

CD-R: A Compact Disc-Recordable disc can be written once and read many times. See also CD-ROM.

CD-RW: A Compact Disc-Read/Write disc can be rewritten many times. See also CD-ROM.

character: Any letter, number, punctuation mark, or symbol used by the computer. Also synonymous with byte.

chassis: The frame containing the computer.

chip: A small semiconductor containing computer logic and circuitry for processing, memory, input/output functions and controlling other chips.

CMOS: Complementary Metal-Oxide Semiconductor. An electronic circuit fabricated on a silicon wafer that requires very little power. Integrated circuits implemented in CMOS technology can be tightly packaged and are highly reliable.

cold start: Starting a computer that is currently off (turning on the power).

COM1, COM2, COM3 and COM4: The names assigned to the serial and communication ports.

commands: Instructions you enter at the terminal keyboard that direct the actions of the computer or its peripheral devices.

communications: The means by which a computer transmits and receives data to and from another computer or device. See parallel interface; serial interface.

compatibility: 1) The ability of one computer to accept and process data in the same manner as another computer without modifying the data or the media upon which it is being transferred.

2) the ability of one device to connect to or communicate with another system or component.

- components:** Elements or parts (of a system) which make up the whole (system).
- computer program:** A set of instructions written for a computer that enable it to achieve a desired result.
- computer system:** A combination of hardware, software, firmware, and peripheral components assembled to process data into useful information.
- configuration:** The specific components in your system (such as the terminal, printer, and disk drives) and the settings that define how your system works. You use the HW Setup program to control your system configuration.
- control keys:** A key or sequence of keys you enter from the keyboard to initiate a particular function within a program.
- controller:** Built-in hardware and software that controls the functions of a specific internal or peripheral device (e.g. keyboard controller).
- co-processor:** A circuit built into the processor that is dedicated to intensive math calculations.
- CPS:** Characters Per Second. Typically used to indicate the transmission speed of a printer.
- CPU:** Central Processing Unit. The portion of the computer that interprets and executes instructions.
- CRT:** Cathode Ray Tube. A vacuum tube in which beams projected on a fluorescent screen-producing luminous spots. An example is the television set.
- cursor:** A small, blinking rectangle or line that indicates the current position on the display screen.

D

- data:** Information that is factual, measurable or statistical that a computer can process, store, or retrieve.
- data bits:** A data communications parameter controlling the number of bits (binary digits) used to make up a byte. If data bits = 7 the computer can generate 128 unique characters. If data bits = 8 the computer can generate 256 unique characters.
- DC:** Direct Current. Electric current that flows in one direction. This type of power is usually supplied by batteries.
- default:** The parameter value automatically selected by the system when you or the program do not provide instructions. Also called a preset value.
- delete:** To remove data from a disk or other data storage device. Synonymous with erase.
- device driver:** A program that controls communication between a specific peripheral device and the computer.
- dialog box:** A window that accepts user input to make system settings or record other information.

disk drive: The device that randomly accesses information on a disk and copies it to the computer's memory. It also writes data from memory to the disk. To accomplish these tasks, the unit physically rotates the disk at high speed past a read-write head.

disk storage: Storing data on magnetic disk. Data is arranged on concentric tracks much like a phonograph record.

diskette: A removable disk that stores magnetically encoded data. Also called a floppy disk.

display: A CRT, LCD, or other image producing device used to view computer output.

documentation: The set of manuals and/or other instructions written for the users of a computer system or application. Computer system documentation typically includes procedural and tutorial information as well as system functions.

DOS: Disk Operating System. See operating system.

driver: A software program, generally part of the operating system, that controls a specific piece of hardware (frequently a peripheral device such as a printer or mouse).

Dual Pointing Device: Pointing device consisting of AccuPoint and Touch Pad. Both of these device can function together or separately. See AccuPoint and Touch Pad.

DVD-RAM: A Digital Versatile Disc Random Access Memory is a high-capacity, high performance disc that lets you store large volumes of data. The DVD-ROM drive uses a laser to read data from the disc.

DVD-ROM: A Digital Versatile Disc Read Only Memory is a high capacity, high performance disc suitable for play back of video and other high-density files. The DVD-ROM drive uses a laser to read data from the disc.

E

echo: To send back a reflection of the transmitted data to the sending device. You can display the information on the screen, or output it to the printer, or both. When a computer receives back data it transmitted to a CRT (or other peripheral device) and then retransmits the data to printer, the printer is said to echo the CRT.

erase: See delete.

escape: 1) A code (ASCII code 27), signaling the computer that what follows are commands; used with peripheral devices such as printers and modems.

2) A means of aborting the task currently in progress.

escape guard time: A time before and after an escape code is sent to the modem which distinguishes between escapes that are part of the transmitted data, and escapes that are intended as a command to the modem.

execute: To interpret and execute an instruction.

Extended Capability Port: An industry standard that provides a data buffer, switchable forward and reverse data transmission, and run length encoding (RLE) support.

F

fast infrared: An industry standard that enables cableless infrared serial data transfer at speeds of up to 4 Mbps.

file: A collection of related information; a file can contain data, programs, or both.

firmware: A set of instructions built into the hardware which controls and directs a microprocessor's activities.

fixed disk: See hard disk.

floppy disk: See diskette.

floppy disk drive (FDD): An electromechanical device that reads and writes to floppy disks. See also diskette.

Fn-esse: A TOSHIBA utility that lets you assign functions to hot keys.

folder: An icon in Windows used to store documents or other folders.

format: The process of readying a blank disk for its first use. Formatting establishes the structure of the disk that the operating system expects before it writes files or programs onto the disk.

function keys: The keys labeled **F1** through **F12** that tell the computer to perform certain functions.

G

gigabyte (GB): A unit of data storage equal to 1024 megabytes. See also megabyte.

graphics: Drawings, pictures, or other images, such as charts or graphs, to present information.

H

hard disk: A non-removable disk usually referred to as drive C. The factory installs this disk and only a trained engineer can remove it for servicing. Also called fixed disk.

hard disk drive (HDD): An electromechanical device that reads and writes a hard disk. See also hard disk.

hardware: The physical electronic and mechanical components of a computer system: typically, the computer itself, external disk drives, etc. See also software and firmware.

hertz: A unit of wave frequency that equals one cycle per second.

hexadecimal: The base 16 numbering system composed of the digits 0 through 9 and the letters A, B, C, D, E, and F.

host computer: The computer that controls, regulates, and transmits information to a device or another computer.

hot key: The computer's feature in which certain keys in combination with the extended function key, **Fn**, can be used to set system parameters, such as speaker volume.

HW Setup: A TOSHIBA utility that lets you set the parameters for various hardware components.

I

icon: A small graphic image displayed on the screen or in the indicator panel. In Windows, an icon represents an object that the user can manipulate.

i.LINK (IEEE1394): This port enables high-speed data transfer directly from external devices such as digital video cameras.

infrared port: A cableless communications port capable of using infrared signals to send serial data.

input: The data or instructions you provide to a computer, communication device or other peripheral device from the keyboard or external or internal storage devices. The data sent (or output) by the sending computer is input for the receiving computer.

instruction: Statements or commands that specify how to perform a particular task.

interface: 1) Hardware and/or software components of a system used specifically to connect one system or device to another.
2) To physically connect one system or device to another to exchange information.
3) The point of contact between user, the computer, and the program, for example, the keyboard or a menu.

interrupt request: A signal that gives a component access to the processor.

I/O: Input/output. Refers to acceptance and transfer of data to and from a computer.

I/O devices: Equipment used to communicate with the computer and transfer data to and from it.

IrDA 1.1: An industry standard that enables cableless infrared serial data transfer at speeds of up to 4 Mbps.

J

jumper: A small clip or wire that allows you to change the hardware characteristics by electrically connecting two points of a circuit.

K

K: Taken from the Greek word kilo, meaning 1000; often used as equivalent to 1024, or 2 raised to the 10th power. See *also* byte and kilobyte.

KB: See kilobyte.

keyboard: An input device containing switches that are activated by manually pressing marked keys. Each keystroke activates a switch that transmits a specific code to the computer. For each key, the transmitted code is, in turn, representative of the (ASCII) character marked on the key.

kilobyte (KB): A unit of data storage equal to 1024 bytes. See *also* byte and megabyte.

L

level 2 cache: See cache.

Light Emitting Diode (LED): A semiconductor device that emits light when a current is applied.

Liquid Crystal Display (LCD): Liquid crystal sealed between two sheets of glass coated with transparent conducting material. The viewing-side coating is etched into character forming segments with leads that extend to the edge of the glass. Applying a voltage between the glass sheets alters the brightness of the liquid crystal.

LSI: Large Scale Integration.

- 1) A technology that allows the inclusion of up to 100,000 simple logic gates on a single chip.
- 2) An integrated circuit that uses large scale integration.

M

main board: See motherboard.

megabyte (MB): A unit of data storage equal to 1024 kilobytes. See *also* kilobyte.

megahertz: A unit of wave frequency that equals 1 million cycles per second. See *also* hertz.

menu: A software interface that displays a list of options on the screen. Also called a screen.

microprocessor: A hardware component contained in a single integrated circuit that carries out instructions. Also called the central processing unit (CPU), one of the main parts of the computer.

mode: A method of operation, for example, the boot mode, standby mode or the hibernation mode.

modem: Derived from modulator/demodulator, a device that converts (modulates) digital data for transmission over telephone lines and then converts modulated data (demodulates) to digital format where received.

monitor: A device that uses rows and columns of pixels to display alphanumeric characters or graphic images. See *also* CRT.

motherboard: A name sometimes used to refer to the main printed circuit board in processing equipment. It usually contains integrated circuits that perform the processor's basic functions and provides connectors for adding other boards that perform special functions. Sometimes called a main board.

MP3: An audio compression standard that enables high-quality transmission and real-time playback of sound files.

N

non-system disk: A formatted diskette (floppy disk) you can use to store programs and data but you cannot use to start the computer. See system disk.

nonvolatile memory: Memory, usually read-only (ROM), that is capable of permanently storing information. Turning the computer's power off does not alter data stored in nonvolatile memory.

numeric keypad overlay: A feature that allows you to use certain keys on the keyboard to perform numeric entry, or to control cursor and page movement.

O

OCR: Optical Character Recognition (reader). A technique or device that uses laser or visible light to identify characters and input them into a storage device.

online state: A functional state of a peripheral device when it is ready to receive or transmit data.

operating system: A group of programs that controls the basic operation of a computer. Operating system functions include interpreting programs, creating data files, and controlling the transmission and receipt (input/output) of data to and from memory and peripheral devices.

output: The results of a computer operation. Output commonly indicates data.

1) printed on paper, 2) displayed at a terminal, 3) sent through the serial port of internal modem, or 4) stored on some magnetic media.

P

parallel interface: Refers to a type of information exchange that transmits information one byte (8 bits) at a time. See *also* serial interface.

parity: 1) The symmetrical relationship between two parameter values (integers) both of which are either on or off; odd or even; 0 or 1.
2) In serial communications, an error detection bit that is added to a group of data bits making the sum of the bits even or odd. Parity can be set to none, odd, or even.

- password:** A unique string of characters used to identify a specific user. The computer provides various levels of password protection such as user, supervisor and eject.
- pel:** The smallest area of the display that can be addressed by software. Equal in size to a pixel or group of pixels. See pixel.
- peripheral component interconnect:** An industry standard 32-bit bus.
- peripheral device:** An I/O device that is external to the central processor and/or main memory such as a printer or a mouse.
- pixel:** A picture element. The smallest dot that can be made on a display or printer. Also called a pel.
- plug and play:** A capability with Windows that enables the system to automatically recognize connections of external devices and make the necessary configurations in the computer.
- port:** The electrical connection through which the computer sends and receives data to and from devices or other computers.
- Power Saver Utility:** A TOSHIBA utility that lets you set the parameters for various power-saving functions.
- printed circuit board (PCB):** A hardware component of a processor to which integrated circuits and other components are attached. The board itself is typically flat and rectangular, and constructed of fiberglass, to form the attachment surface.
- program:** A set of instructions a computer can execute that enables it to achieve a desired result. See also application.
- prompt:** A message the computer provides indicating it is ready for or requires information or an action from you.

R

- Radio frequency interference (RFI) shield:** A metal shield enclosing the printed circuit boards of the printer or computer to prevent radio and TV interference. All computer equipment generates radio frequency signals. The FCC regulates the amount of signals a computing device can allow past its shielding. A Class A device is sufficient for office use. Class B provides a more stringent classification for home equipment use. TOSHIBA portable computers comply with Class B computing device regulations.
- Random Access Memory (RAM):** High speed memory within the computer circuitry that can be read or written to.
- restart:** Resetting a computer without turning it off (also called “warm boot” or “soft reset”). See also boot.
- RGB:** Red, green, and blue. A device that uses three input signals, each activating an electron gun for a primary additive color (red, green, and blue) or port for using such a device. See also CRT.
- RJ11:** A modular telephone jack.

RJ45: A modular LAN jack.

ROM: Read Only Memory: A nonvolatile memory chip manufactured to contain information that controls the computer's basic operation. You cannot access or change information stored in ROM.

S

SCSI: Small Computer System Interface is an industry standard interface for connection of a variety of peripheral devices.

SD cards: Secure Digital cards are flash memory widely used in a variety of digital devices such as digital cameras and Personal Digital Assistants.

serial communications: A communications technique that uses as few as two interconnecting wires to send bits one after another.

serial interface: Refers to a type of information exchange that transmits information sequentially, one bit at a time. Contrast: Parallel interface.

SIO: Serial Input/Output. The electronic methodology used in serial data transmission.

soft key: Key combinations that emulate keys on the IBM keyboard, change some configuration options, stop program execution, and access the numeric keypad overlay.

software: The set of programs, procedures and related documentation associated with a computer system. Specifically refers to computer programs that direct and control the computer system's activities. *See also* hardware.

stop bit: One or more bits of a byte that follow the transmitted character or group codes in asynchronous serial communications.

subpixel: Three elements, one red, one green and blue (RGB), that make up a pixel on the color LCD. The computer sets subpixels independently, each may emit a different degree of brightness. *See also* pixel.

synchronous: Having a constant time interval between successive bits, characters or events.

system disk: A disk that has been formatted with an operating system. For MS-DOS the operating system is contained in two hidden files and the COMMAND.COM file. You can boot a computer using a system disk. Also called an operating system disk.

T

terminal: A typewriter-like keyboard and CRT display screen connected to the computer for data input/output.

TFT display: A liquid crystal display (LCD) made from an array of liquid crystal cells using active-matrix technology with thin film transistor (TFT) to drive each cell.

TouchPad: A pointing device integrated into the TOSHIBA computer palm rest.

TTL: Transistor-transistor logic. A logic circuit design that uses switching transistors for gates and storage.

U

Universal Serial Bus: This serial interface lets you communicate with several devices connected in a chain to a single port on the computer.

V

VGA: Video Graphics Array is an industry standard video adaptor that lets you run any popular software.

volatile memory: Random access memory (RAM) that stores information as long as power is supplied to the computer.

W

warm start: Restarting or resetting a computer without turning it off.

window: A portion of the screen that can display its own application, document or dialog box. Often used to mean a Microsoft Windows window.

write protection: A method for protecting a diskette (floppy disk) from accidental erasure.

Index

A

- AC adaptor 1-4, 2-17
 - Connecting 3-4
- AC Power Cord B-1
- Accessing HW Setup 7-1
- AccuPoint 2-9, 4-2
- Advanced Port Replicator III 1-16, 8-21
- Analyzing a problem 9-2
- ASCII Character Codes E-1
- ASCII characters E-1

B

- Backside 2-5
- Battery
 - 2nd battery 6-6
 - additional 8-15
 - High capacity battery 6-6
 - Main battery 6-5
 - monitoring capacity 6-11
 - Real Time Clock battery 6-6
- Battery charger 8-16
- Battery lock 2-6
- Battery pack 2-6
- Battery types 6-5
- Bluetooth 4-25
- Boot mode 3-7
- Boot Priority 7-4

C

- Caps Lock 5-1
- Care and use of the battery pack 6-7
- CD-RW/DVD-ROM 1-5, 2-15, 4-10
- CDs 2-14
 - Writing 4-10
- Charging the batteries 6-9
- Cleaning the computer 4-28
- Communications 1-8
- Connecting LAN cable 4-27
- Connectors B-1

D

- DC IN 15V 2-5
- DC IN 15V indicator 6-4
- Device Config 7-2
- Disconnecting LAN cable 4-28
- Disks 1-4
- Display 1-6, 2-8, 3-5
- Displaying movies on a TV or CRT 8-18
- Docking interface 2-6
- Drag'n Drop CD+DVD 4-15
- DVD
 - Dual drive 2-16
 - Multi drive 2-16
- DVD Multi drive 1-5, 4-11
- DVD±R/±RW 2-16
- DVD±R/±RW drive 1-6, 4-12
- DVD-ROM 1-4, 2-15

E

Emulating keys 5-2
 Environmental Requirements A-1
 Extending battery life 6-12
 External monitor 2-4, 8-17

F

F1 ... F12 function keys 5-2
 Fn + Esc 5-4
 Fn + F1 5-4
 Fn + F10 5-7
 Fn + F11 5-7
 Fn + F2 5-4
 Fn + F3 5-4
 Fn + F4 5-5
 Fn + F5 5-5
 Fn + F6 5-5
 Fn + F7 5-5
 Fn + F8 5-6
 Fn + F9 5-6
 Fn + space keys 5-6
 Fn key 5-2
 Fn Sticky key 5-6
 Formatting an SD card 8-4
 Front 2-1, 2-8

G

General conditions 3-2
 Generating ASCII characters 5-9
 Glossary

H

Hard disk drive 1-4
 Hard disk drive pack 8-13
 Headphone 2-3
 Heat dispersal 4-29
 Hibernation mode 3-7
 Hot keys 5-4
 HW Setup
 LAN 7-8
 HW Setup 7-1

I

i.LINK 2-2, 8-19, 8-22
 Indicator
 Battery 6-4
 Power 6-5
 Infrared port 2-1
 Inserting a PC card 8-2
 Installing an SD card 8-4
 Installing the battery pack 6-14
 Installing the HDD pack 8-14
 Internal Modem Guide G-1

K

Keyboard 5-1
 Keyboard indicators 2-12
 Keypad overlay 5-7

L

LAN 4-27, 7-7
 cable types 4-27
 jack 2-5
 LAN active indicator 2-5
 Left side 2-2
 Link indicator 2-5

M

Media care 4-18
 Memory 1-3
 Memory expansion 8-6
 Memory module 2-7
 Microphone 2-3, 2-8
 Modem 2-5, 4-21
 Monitoring battery capacity 6-11
 Moving the computer 4-29
 Multimedia 1-8

N

Network Operating System F-1

O

Optical media drives
 using 4-6
 Optical media drives 2-14
 Optional Devices 8-1
 Options 1-15

P

- Panel power on/off 6-18
- Parallel port 2-2
- PC card slot 2-3
- PC cards 8-2
- Physical Dimensions A-1
- Placement of the computer 3-2
- Ports 1-7
- Power
 - Turning off 3-7
 - Turning on 3-6
- Power button 2-10
- Power conditions 6-1
- Power indicators 6-4
- Power-up modes 6-18
- Preliminary checklist 9-2
- Printer
 - parallel 8-22
- Problem solving process 9-1
- Problems
 - AC power 9-5
 - Battery 9-5
 - Bluetooth 9-20
 - CD-RW/DVD-ROM drive 9-9
 - DVD Multi drive 9-11
 - DVD±R/±RW drive 9-12
 - DVD-ROM drive 9-8
 - Floppy disk drive 9-13
 - Hard disk drive 9-7
 - Hardware and system checklist 9-3
 - i.LINK 9-18
 - Infrared port 9-14
 - Keyboard 9-7
 - LAN 9-19
 - LCD panel 9-7
 - Memory expansion 9-17
 - Modem 9-18
 - Monitor 9-18
 - Password 9-6
 - PC card 9-14
 - Power 9-4
 - SD card 9-14
 - Sound system 9-17
 - TOSHIBA Dual Pointing Device 9-15
 - USB 9-16
 - Wireless LAN 9-20

- Processor 1-3
- Product Recovery DVD-ROM 3-11

R

- Region codes
 - DVD drives 2-14
- Region selection 4-21
- Removing a PC card 8-3
- Removing an SD card 8-4
- Removing discs 4-9
- Removing memory module 8-12
- Removing the battery pack 6-13
- Removing the HDD pack 8-13
- Replacing the battery pack 6-13
- Restarting the computer 3-10
- Restoring the preinstalled software 3-11
- Right side 2-3
- RTC battery 1-3

S

- SD card care 8-5
- SD card slot 2-2
- SD cards 8-3
- Seating and posture 3-3
- Security lock 2-3, 8-22
- Self test 9-4
- Setting up 3-1
- Shut Down mode 3-7
- Slim Select Bay 2-3, 2-7
 - modules 1-9, 4-4
 - options 1-16
- Slots 1-7
- Soft keys 5-2
- Software 1-10
- Sound System 4-19
- SoundMAX control panel 4-19
- Special features 1-10
- Specifications A-1
- Standby mode 3-9
- Starting the computer by password 6-17
- Stereo speakers 2-8
- Stolen computer D-1
- Supervisor password 6-17
- System Auto Off 6-18
- System indicators 2-11

T

Temporarily changing modes 5-8
TOSHIBA Audio Effect 1-15
TOSHIBA ConfigFree 1-14
TOSHIBA Console 1-14
TOSHIBA Console button 2-9
TOSHIBA Controls 1-13
TOSHIBA Dual Pointing Device 1-7, 4-1
TOSHIBA IP Phone 1-14
TOSHIBA Mobile Extension 1-14
TOSHIBA PC DiagnosticTool 1-14
TOSHIBA Power Saver 1-13
TOSHIBA Presentation button 2-9
TOSHIBA SD Memory Boot Utility 1-13
TOSHIBA support 9-21
TOSHIBA Theft Registration D-2
TOSHIBA Zooming Utility 1-13, 5-6
Touch Pad 2-9, 4-2
Troubleshooting 9-1
TV 8-18
Typewriter keys 5-1

U

Underside 2-6
Universal Serial Bus (USB 2.0) 2-4
USB 7-8
USB floppy disk drive 1-4, 2-13
 Using 4-3
Utilities 1-13

V

Video RAM 1-3
Video-out 2-5
Volume control 2-1

W

Windows special keys 5-7
Windows XP setup 3-1
Wireless communication 2-2, 4-24
Wireless LAN 1-9, 4-24, F-1
Writable discs 2-14
Writing CD/DVDs 4-11, 4-12